



nueva colección  
new collection

2020





## Entender la esencia de cada uno, es emprender un viaje.

El nuestro empieza y acaba en esta orilla del Mediterráneo.  
Lugar y gente de costa que se echa a la mar. Mira lejos. Y lleva  
su saber a otros puertos.  
Y entre esa gente: esta familia. Porque, ante todo, somos eso.  
Familia. Por legado y por actitud.

## Understanding the essence of each one is to undertake a journey.

Ours begins and ends on this shore of the Mediterranean.  
Where the light shines with a special purity and intensity, lighting  
everything extremely clearly and flawlessly. We take this knowledge to  
other ports, other people.  
And among those people: this family. Because, above all, we are that.  
Family. By legacy and by attitude.

BPM Lighting



ALBERTA INSIDE

La 1



Let's get brighter

Perfección  
tiene forma circular.



ALBERTA DUE

Perfection  
has a circular shape.



ALBERTA INSIDE



OKKO



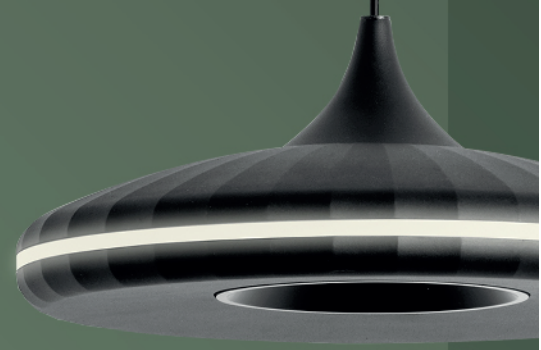

# Luminarias Co Stat

SUBLIM  
composition

SUBLIM  
two sizes

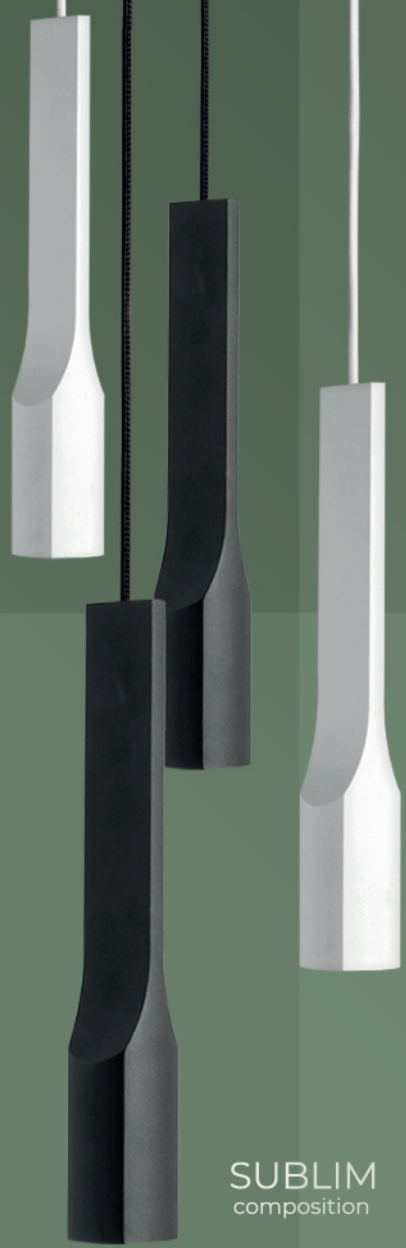

KIERA



IRIS



FACE

# Pendantes de Vanguardia State-of-the-Art Pendant Lights



Let's get brighter

KIERA CEM



GALANTA







Creando nuevas formas  
Creating new forms



**BPM**Lighting®

Let's get brighter



formas de iluminar.  
new ways of lighting



## ALARIK SLIM

Infinitas posibilidades en versión mini  
Infinite possibilities in mini version







# La Experiencia Outdoor

Los espacios al aire libre destacarán con piezas únicas diseñadas para que la luz se disipe armoniosamente, como parte de una pieza integrada en el ambiente.

# The Outdoor Experience

The outdoor spaces will stand out with unique pieces designed to diffuse the light harmoniously, as part of a single unit integrated into the surrounding.



**BPM**Lighting®

Let's get brighter

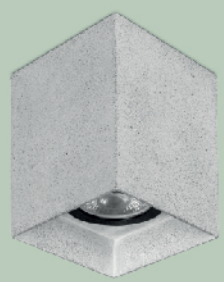

**NOCTÚA**  
OUT

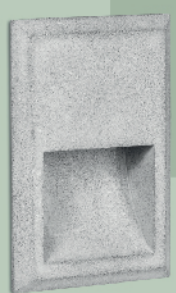

**ARA**  
OUT



**DRACO**  
OUT

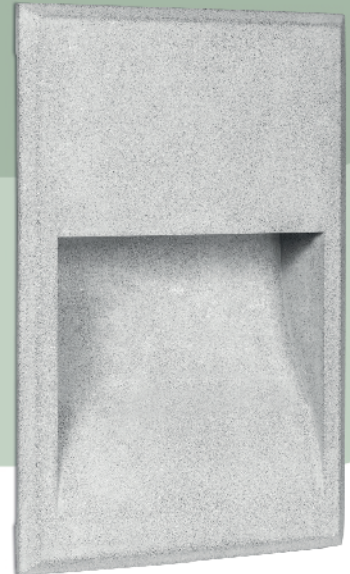

**ZAHARA**  
OUT

# REDUGER®

TECH SOLUTION UGR<19



Let's get brighter

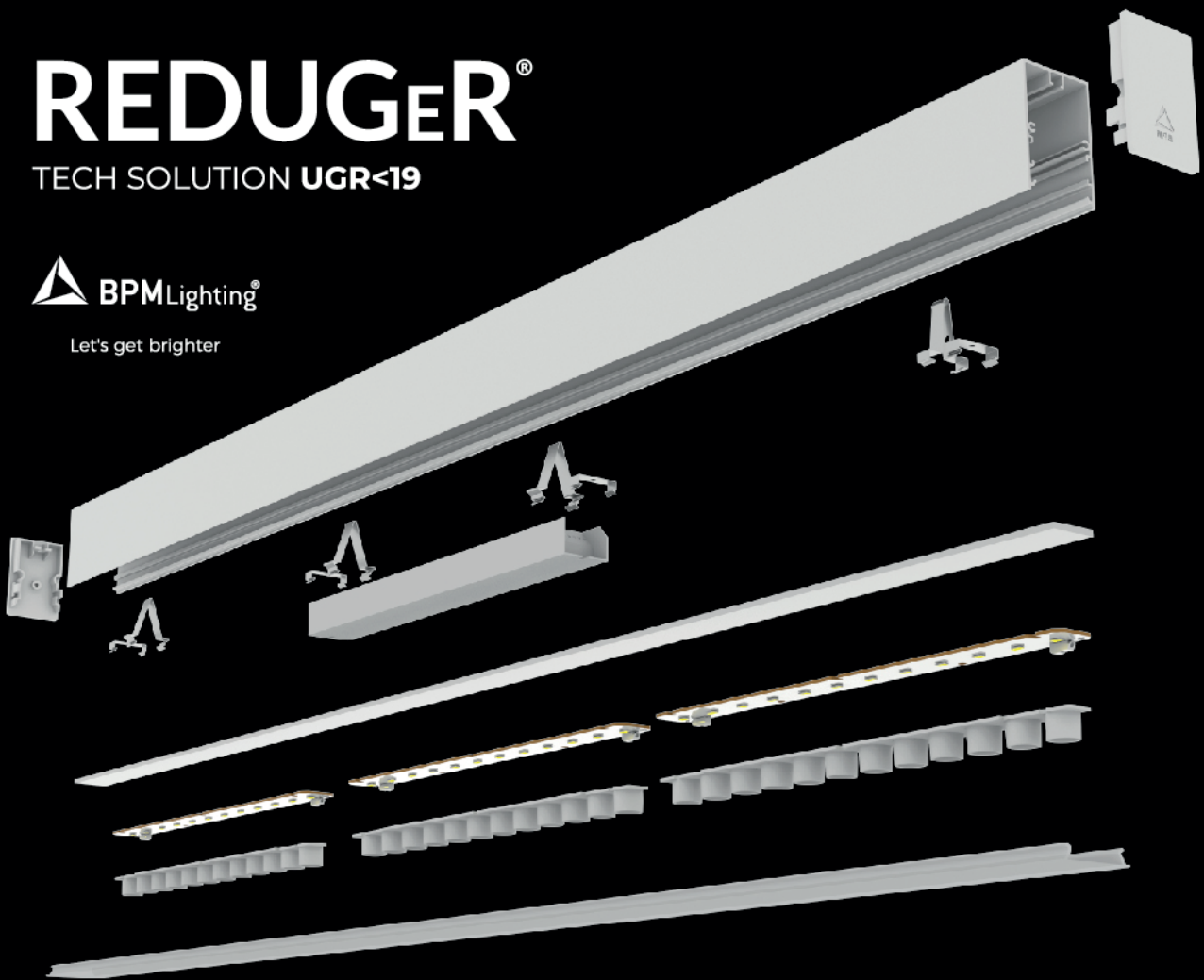

## TECH SOLUTION UGR<19

before REDUGER



Beam diameter (m) Beam diameter (m)  
 ———— 0.5m (19.7") (at height 0.5m)  
 ———— 1.0m (39.4") (at height 1.0m)  
 ———— 1.5m (59.1") (at height 1.5m)  
 ———— 2.0m (78.7") (at height 2.0m)  
 ———— 2.5m (98.4") (at height 2.5m)  
 ———— 3.0m (118.1") (at height 3.0m)

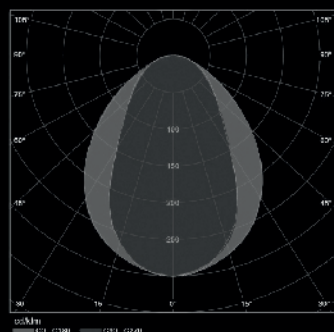

0.5m 1.0m 1.5m 2.0m 2.5m 3.0m

after REDUGER

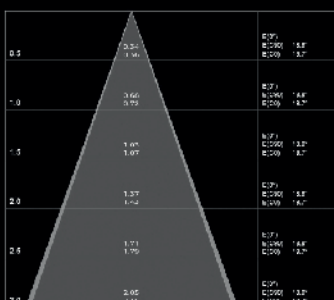

Beam diameter (m) Beam diameter (m)  
 ———— 0.5m (19.7") (at height 0.5m)  
 ———— 1.0m (39.4") (at height 1.0m)  
 ———— 1.5m (59.1") (at height 1.5m)  
 ———— 2.0m (78.7") (at height 2.0m)  
 ———— 2.5m (98.4") (at height 2.5m)  
 ———— 3.0m (118.1") (at height 3.0m)

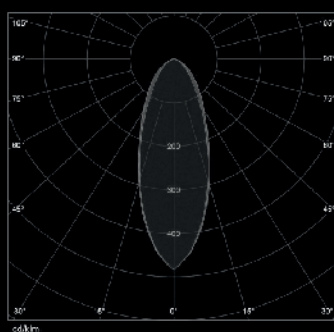

0.5m 1.0m 1.5m 2.0m 2.5m 3.0m

BPM Lighting presenta el Sistema REDUGER a través de un dispositivo que añadido a nuestras luminarias focaliza el haz de luz y proporciona un UGR, 100% compatible con la normativa europea UNE 12464-1.

¡Descúbrelo!

BPM Lighting introduces REDUGER, a patented device that being added to our luminaires, focuses the light beam and provides an optimum UGR, 100% compatible with European standards UNE 12464-1

Find out!





## Let's get brighter

Es nuestra mentalidad, especialmente en estos tiempos de incertidumbre en los que trabajaremos juntos para salir más fuertes, más resistentes, más conectados, más empáticos, más comprometidos, más flexibles ... ¡MÁS BRILLANTES!  
¡Juntos, seremos más brillantes!

## Let's get brighter

Let's get brighter, It's our mindset.

In these times of uncertainty, we will work together to come out stronger, more resilient, more connected, more thoughtful, more committed, more flexible... BRIGHTER!  
Together, we will get brighter!

let's co-create  
with ALARIK SLIM

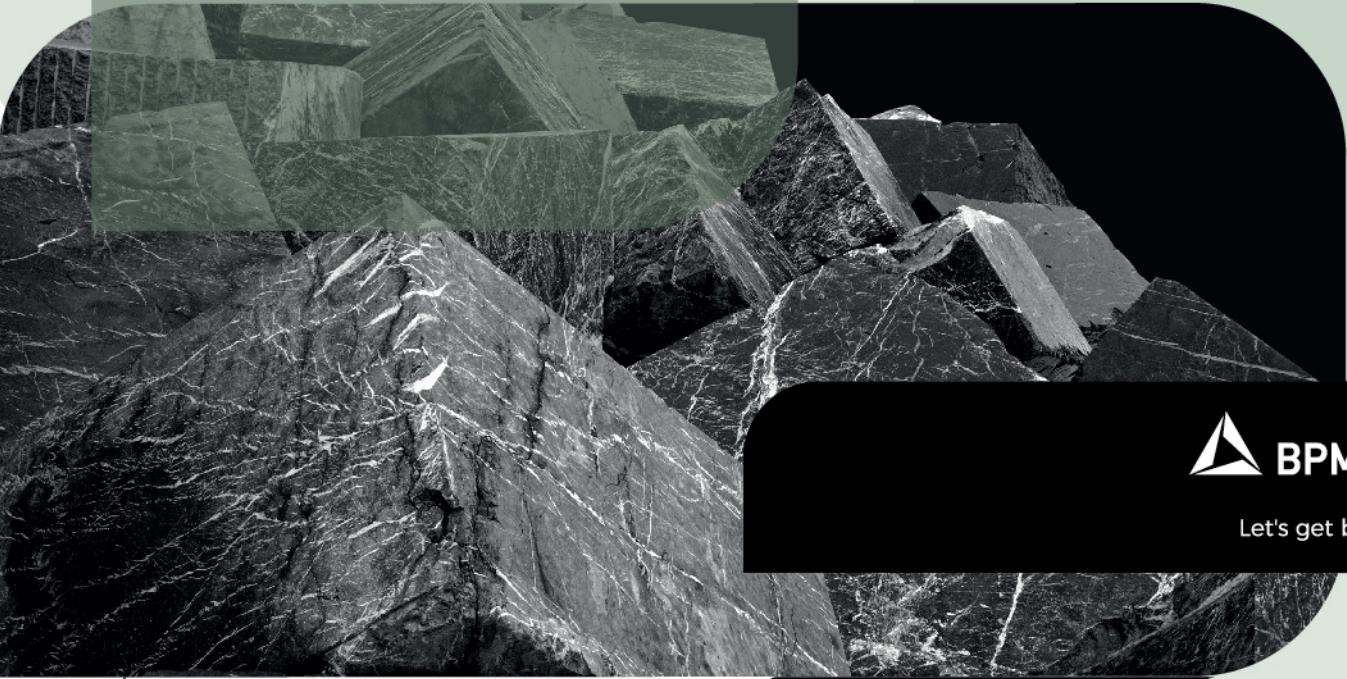

 **BPM**Lighting®

Let's get brighter





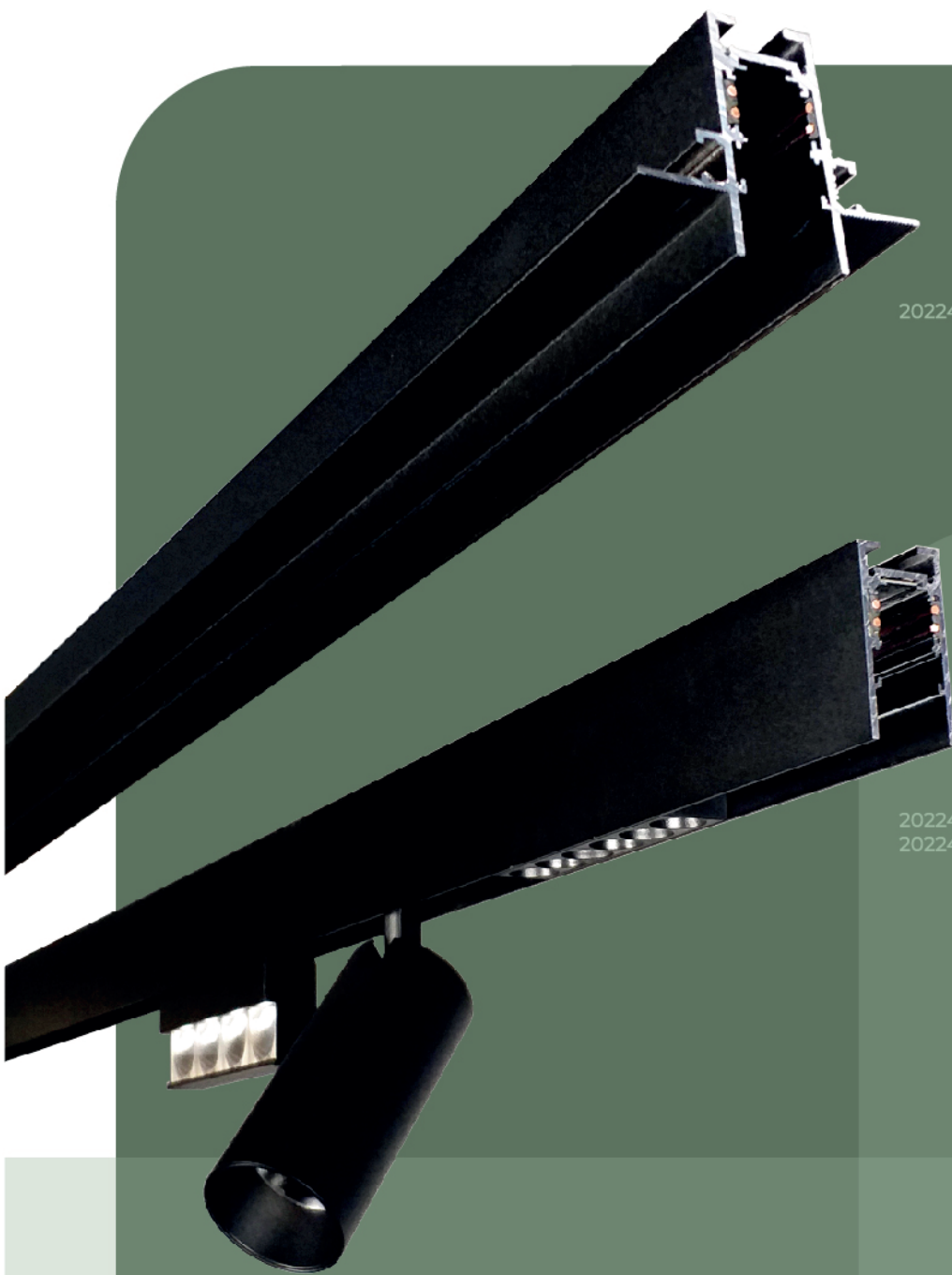

20224.TR

20224.SR  
20224.PN

# ALARIK SLIM

Infinite possibilities in mini version



Let's get brighter



Let's get brighter

# ALARIK SLIM

Infinite possibilities in mini version

## GENERAL DETAILS

REFERENCE:	20224
INSTALLATION:	Trimless   Surface   Pendant
EXTERNAL FINISH:	White · Black
MATERIAL:	Aluminium
IP DEGREE:	IP40
IK:	IK06
FORM:	Square
REGULATION:	DALI   1..10
UTILIZATION:	Indoor
WARRANTY:	5 years

## GENERAL DIMENSIONS

<b>20224.SR</b>	: 26.5 X 54 X L mm.
<b>20224.PN</b>	: 26.5 X 54 X L mm.
<b>20224.TR</b>	: ext ( 70.1 X 54 ) 26.5 X 54 X L mm.

MAXIMUM CABLE LENGTH 2000 mm

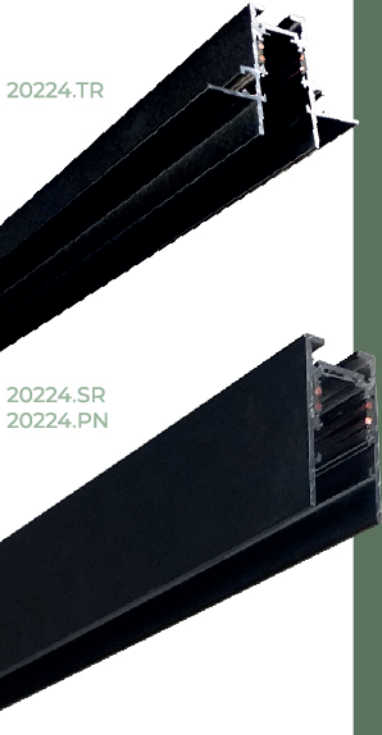

20224.SR  
20224.PN

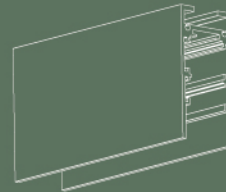
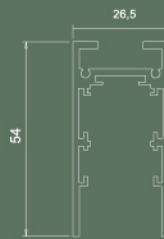

20224.TR

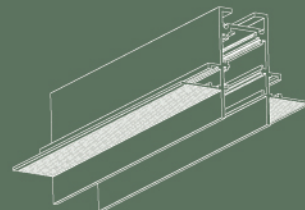
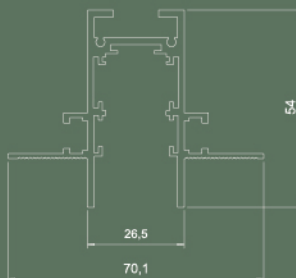





SLIM PATRICIA  
S | M | L

FOR ALARIK SLIM



Let's get brighter

CE 

 **BPM**Lighting®

Let's get brighter

# SLIM PATRICIA

S | M | L

FOR ALARIK SLIM

## GENERAL DETAILS

REFERENCE:	11544 S   11545 M   11546 L
INSTALLATION:	ALARIK SLIM MODULE
EXTERNAL FINISH:	.BK Black   .W White
MATERIAL:	Aluminium
IP DEGREE:	IP20
IK:	IK06
FORM:	Round
LIGHT DIRECTION:	Oscillation
BEAM ANGLE S   M :	15°   38°   60°
BEAM ANGLE L :	15° - 36°   36° - 60°

## GENERAL DIMENSIONS

DIMENSIONS:	CROQUIS
MINIMUM DISTANCE TO ILLUMINATED OBJECT:	0.5 m

## ELECTRICAL DETAILS

LAMP:	LED
LED TYPE:	BRIDGELUX
PROTECTION CLASS:	
ENERGETIC EFFICIENCY:	A+
CONSTANT VOLTAGE:	48 V
VOLTAGE:	230 V
LIFE TIME:	50.000 h
LUMEN MAINTENANCE:	L80_B10: 50000
CRI:	≥90
MACADAM:	<3





CE 



Let's get brighter

# SLIM PATRICIA S | M | L

FOR ALARIK SLIM



SLIM PATRICIA S 11544

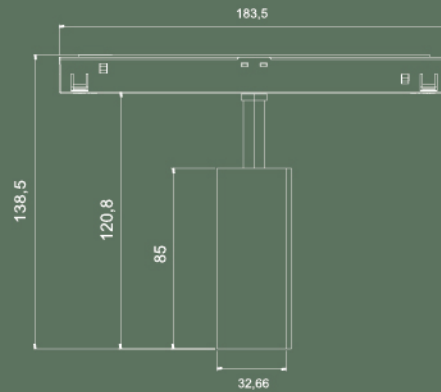

		EFFICIENCY	LUMENS
POWER	8W	EFF 2700K: 75 lm/w	2700K lm: 579 lm
		EFF 3000K: 79 lm/w	3000K lm: 607 lm
		EFF 4000K: 90 lm/w	4000K lm: 695 lm



SLIM PATRICIA M 11545

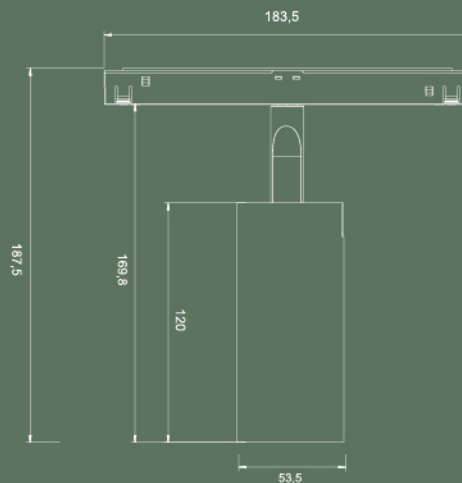

		EFFICIENCY	LUMENS
POWER	13W	EFF 2700K: 90 lm/w	2700K lm: 1173 lm
		EFF 3000K: 90 lm/w	3000K lm: 1181 lm
		EFF 4000K: 93 lm/w	4000K lm: 1207 lm

CE 

 **BPM**Lighting®

Let's get brighter

# SLIM PATRICIA

S | M | L

FOR ALARIK SLIM



SLIM PATRICIA L 11546

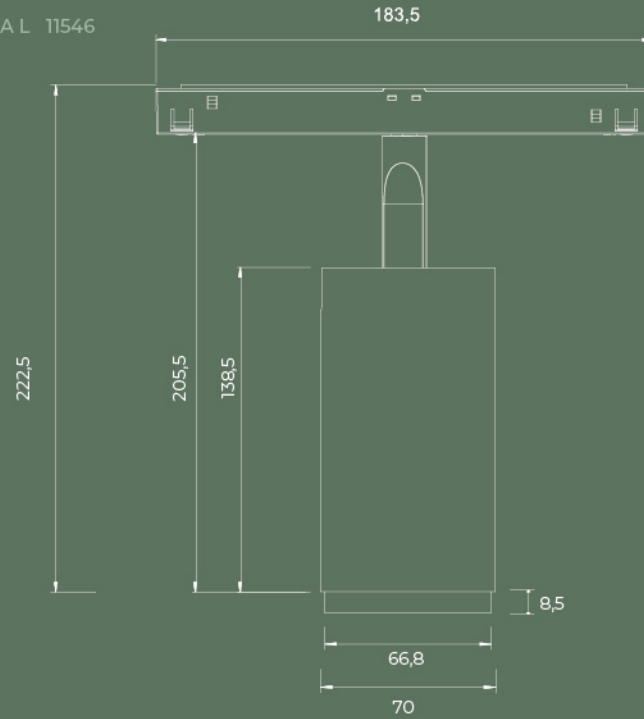

POWER	22W	EFFICIENCY	LUMENS
		EFF 2700K: 92 lm/w	2700K lm: 2038 lm
		EFF 3000K: 104 lm/w	3000K lm: 2254 lm
		EFF 4000K: 105 lm/w	4000K lm: 2320 lm



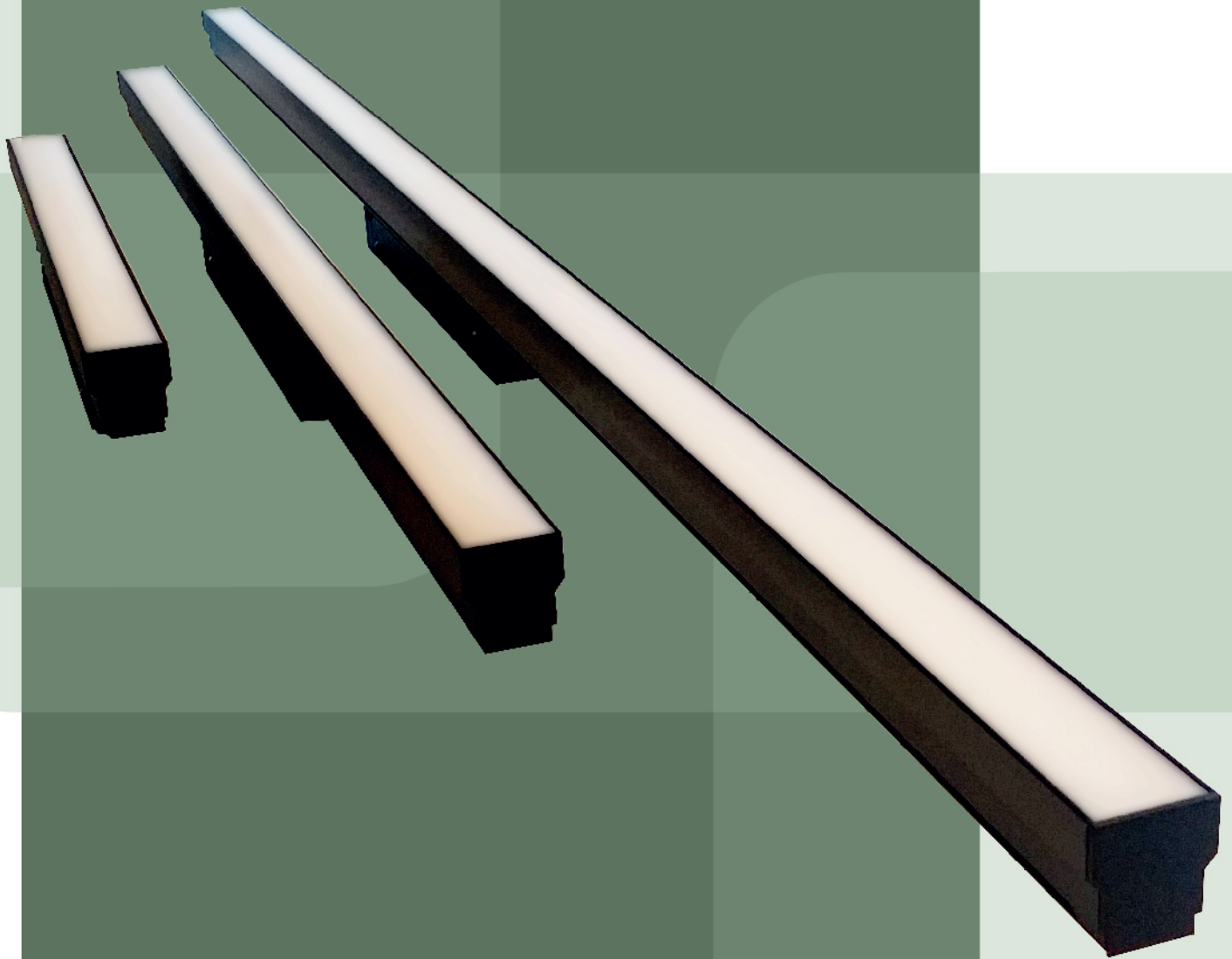

SLIM LED MODULES  
FOR ALARIK SLIM



Let's get brighter



Let's get brighter

## SLIM LED MODULES

FOR ALARIK SLIM

### GENERAL DETAILS

REFERENCE:	11549.01   11549.02   11549.03
INSTALLATION:	ALARIK SLIM MODULE
EXTERNAL FINISH:	.BK Black
MATERIAL:	Aluminium
IP DEGREE:	IP20
IK:	IK06
LIGHT DIRECTION:	Fixed
OPTIC COVER:	Opal

### GENERAL DIMENSIONS

DIMENSIONS:	11549.01: 303 X 43 X 22,8 mm. 11549.02 : 603 X 43 X 22,8 mm. 11549.03 : 903 X 43 X 22,8 mm.
MINIMUM DISTANCE TO ILLUMINATED OBJECT:	0,5 m

### ELECTRICAL DETAILS

LAMP:	LED
LED TYPE:	OSRAM
PROTECTION CLASS:	
ENERGETIC EFFICIENCY:	A+
CONSTANT VOLTAGE:	48 V
VOLTAGE:	230 V
LIFE TIME:	35.000 h
LUMEN MAINTENANCE:	L80_B10: 35000
CRI:	≥90
MACADAM:	<3





Let's get brighter

# SLIM LED MODULES

FOR ALARIK SLIM



11549.01



POWER	8,9W	EFFICIENCY		LUMENS	
		EFF 2700K:	62 lm/w	2700K lm:	558 lm
		EFF 3000K:	63.6 lm/w	3000K lm:	560 lm
		EFF 4000K:	80 lm/w	4000K lm:	604 lm

15549.02



POWER	17.8W	EFFICIENCY		LUMENS	
		EFF 2700K:	62 lm/w	2700K lm:	1115 lm
		EFF 3000K: <td>63 lm/w</td> <td>3000K lm: <td>1120 lm</td> </td>	63 lm/w	3000K lm: <td>1120 lm</td>	1120 lm
		EFF 4000K: <td>80 lm/w</td> <td>4000K lm: <td>1208 lm</td> </td>	80 lm/w	4000K lm: <td>1208 lm</td>	1208 lm

15549.03



POWER	20,63W	EFFICIENCY		LUMENS	
		EFF 2700K:	62 lm/w	2700K lm:	1670 lm
		EFF 3000K: <td>63 lm/w</td> <td>3000K lm: <td>1680 lm</td> </td>	63 lm/w	3000K lm: <td>1680 lm</td>	1680 lm
		EFF 4000K: <td>80 lm/w</td> <td>4000K lm: <td>1812 lm</td> </td>	80 lm/w	4000K lm: <td>1812 lm</td>	1812 lm



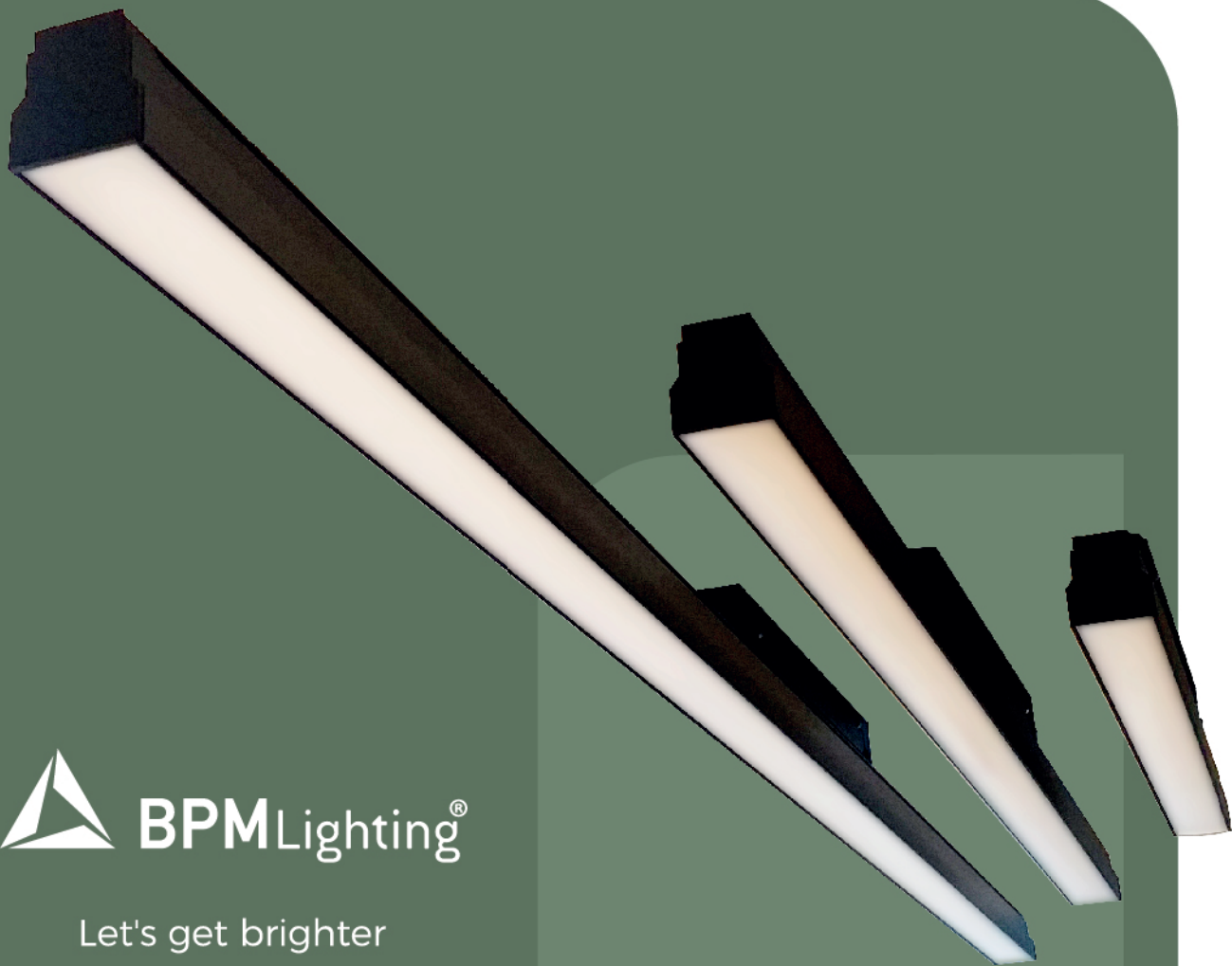

 **BPM**Lighting®

Let's get brighter



SLIM LENSES  
FOR ALARIK SLIM



Let's get brighter

CE 



Let's get brighter



## SLIM LENSES

FOR ALARIK SLIM

### GENERAL DETAILS

REFERENCE:	11548.06   11548.12
INSTALLATION:	ALARIK SLIM MODULE
EXTERNAL FINISH:	.BK Black
MATERIAL:	Aluminium
IP DEGREE:	IP20
IK:	IK06
BEAM ANGLE:	15°   38°
LIGHT DIRECTION:	Fixed

### GENERAL DIMENSIONS

DIMENSIONS:	* CROQUIS
MINIMUM DISTANCE TO ILLUMINATED OBJECT:	0.5 m

### ELECTRICAL DETAILS

LAMP:	LED
LED TYPE:	OSRAM
PROTECTION CLASS:	
ENERGETIC EFFICIENCY:	A+
CONSTANT VOLTAGE:	48 V
VOLTAGE:	230 V
LIFE TIME:	35.000 h
LUMEN MAINTENANCE:	L80_B10: 35000
CRI:	≥90
MACADAM:	<3





Let's get brighter

# SLIM LENSES

FOR ALARIK SLIM



11548.12

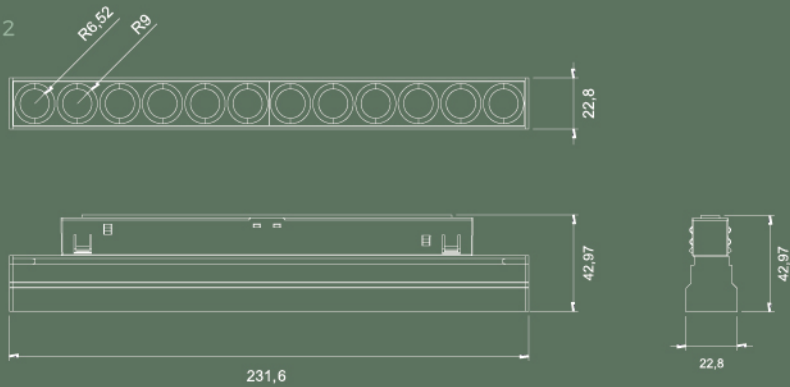

		EFFICIENCY	LUMENS
POWER	18 W	EFF 2700K: 74 lm/w	2700K lm: 1320 lm
		EFF 3000K: 83 lm/w	3000K lm: 1511 lm
		EFF 4000K: 93 lm/w	4000K lm: 1654 lm

11548.06

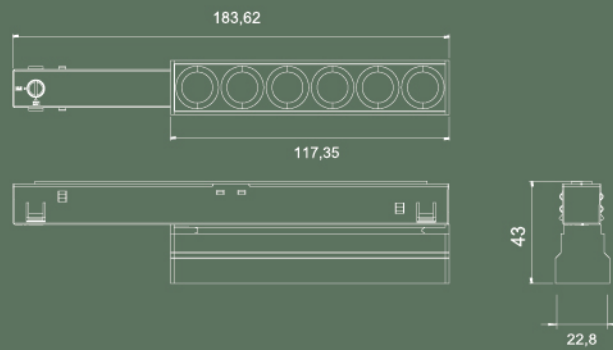

		EFFICIENCY	LUMENS
POWER	9 W	EFF 2700K: 74 lm/w	2700K lm: 660 lm
		EFF 3000K: 83 lm/w	3000K lm: 750 lm
		EFF 4000K: 93 lm/w	4000K lm: 827 lm

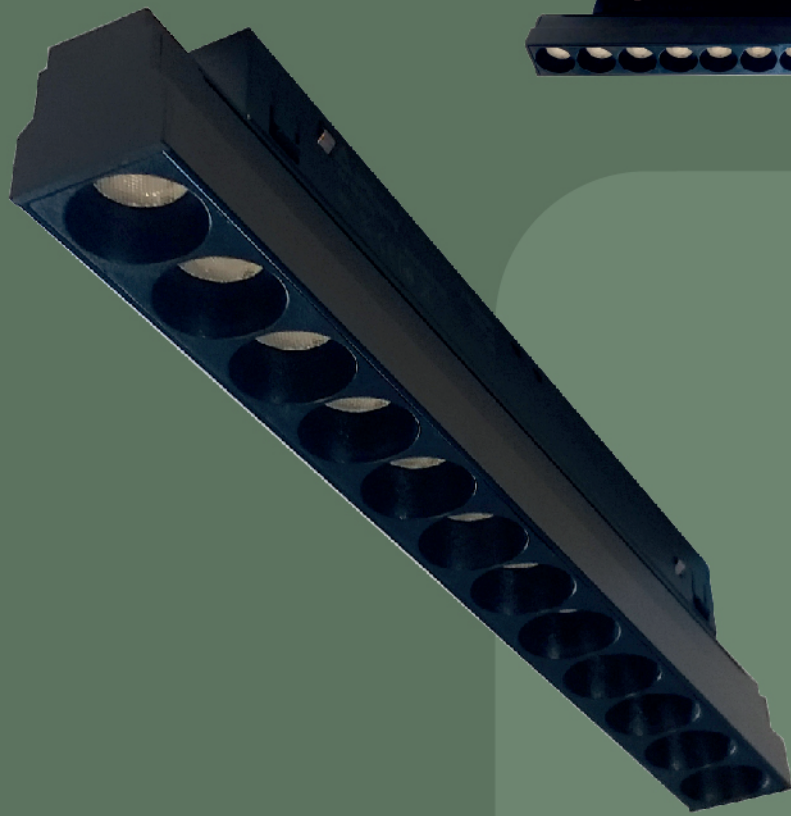

Let's get brighter



SLIM MOTION LENSES  
FOR ALARIK SLIM



Let's get brighter





Let's get brighter

# SLIM MOTION LENSES

FOR ALARIK SLIM



## GENERAL DETAILS

REFERENCE:	11547
INSTALLATION:	ALARIK SLIM MODULE
EXTERNAL FINISH:	.BK Black
MATERIAL:	Aluminium
IP DEGREE:	IP20
IK:	IK06
BEAM ANGLE:	15°   38°
LIGHT DIRECTION:	Oscillation

## GENERAL DIMENSIONS

DIMENSIONS:	* CROQUIS
MINIMUM DISTANCE TO ILLUMINATED OBJECT:	0.5 m

## ELECTRICAL DETAILS

LAMP:	LED
LED TYPE:	OSRAM
PROTECTION CLASS:	⏏
ENERGETIC EFFICIENCY:	A+
CONSTANT VOLTAGE:	48 V
VOLTAGE:	230 V
LIFE TIME:	35.000 h
LUMEN MAINTENANCE:	L80_B10: 35000
CRI:	≥90
MACADAM:	<3

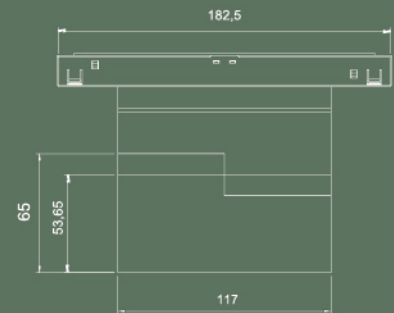

POWER	9,18 W	EFFICIENCY		LUMENS	
		EFF 2700K:	74 lm/w	2700K lm:	660 lm
		EFF 3000K:	82,86 lm/w	3000K lm:	750 lm
		EFF 4000K:	93 lm/w	4000K lm:	827 lm



# SLIM WALL WASHER

FOR ALARIK SLIM

 **BPM**Lighting®

Let's get brighter



Let's get brighter

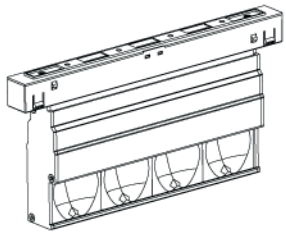

# SLIM WALL WASHER

FOR ALARIK SLIM

## GENERAL DETAILS

REFERENCE:	11550
INSTALLATION:	ALARIK SLIM MODULE
EXTERNAL FINISH:	.BK Black
MATERIAL:	Aluminium
IP DEGREE:	IP20
IK:	IK06
BEAM ANGLE:	Wall washer
LIGHT DIRECTION:	Fixed

## GENERAL DIMENSIONS

DIMENSIONS:	* CROQUIS
MINIMUM DISTANCE TO ILLUMINATED OBJECT:	0.5 m

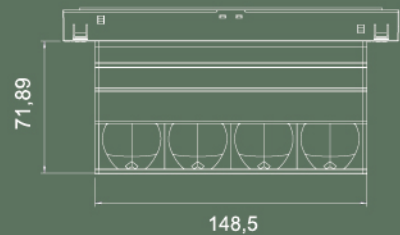

## ELECTRICAL DETAILS

LAMP:	LED
LED TYPE:	CREE
PROTECTION CLASS:	III
ENERGETIC EFFICIENCY:	A+
CONSTANT VOLTAGE:	48 V
VOLTAGE:	230 V
LIFE TIME:	35.000 h
LUMEN MAINTENANCE:	L80_B10: 35000
CRI:	≥90
MACADAM:	<3

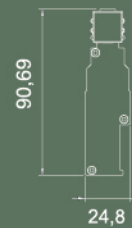

POWER	13W	EFFICIENCY		LUMENS	
		EFF 2700K: 85 lm/w	2700K lm: 1100 lm	EFF 3000K: 87 lm/w	3000K lm: 1169 lm





ALARIK SLIM  
ACCESORIES



Let's get brighter



Let's get brighter

# ALARIK SLIM

## ACCESORIES

### 10246.CA

POWER FEEDER UNIT  
2000 x 17 x 16 BLACK

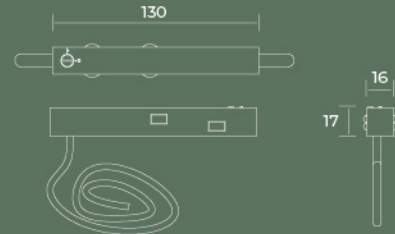

### 10246.UA

ANGLE FLEXIBLE JOINT  
130 x 17 x 16 BLACK

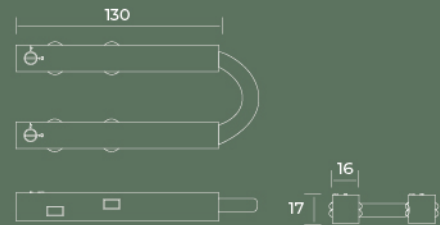

### 10246.UL

LINEAR JOINT  
160 x 17 x 22 BLACK



### 10246.PK

PENDANT KIT  
( CEILING FASTENER  
CABLE SUSPENSION )  
2000 x 35 x 22,5 BLACK

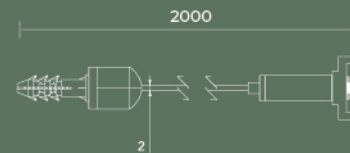

### 10246.PKDB

PENDANT KIT  
WITH DRIVER BOX  
2000 x 36 x 54 BLACK

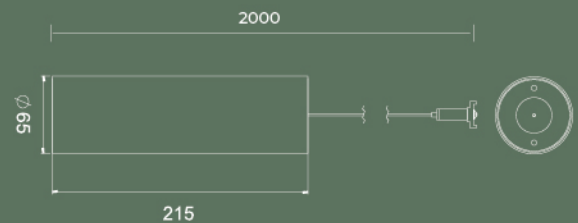

## ALARIK SLIM COVER KIT

### CK29.TR

COVER KIT  
TRIMLESS

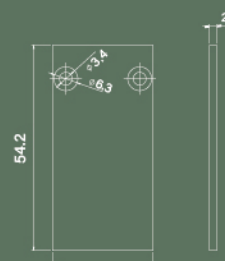

### CK29.SR

### CK29.PN

COVER KIT  
SURFACE  
PENDANT

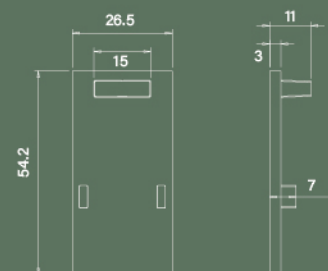

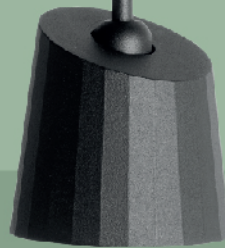
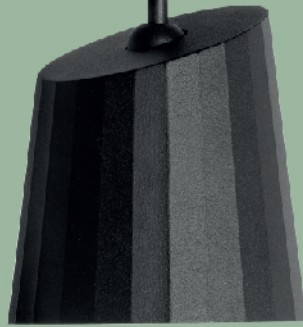
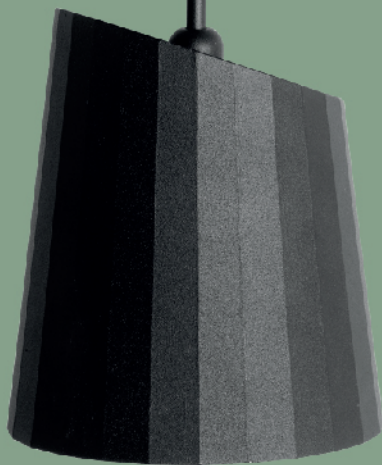

KIERA  
Serene and Atemporal



Let's get brighter

CE 



Let's get brighter



# KIERA

FAMILY

## GENERAL DETAILS

REFERENCE:	20204 S   M   L
INSTALLATION:	Pendant
EXTERNAL FINISH:	White · Black
MATERIAL:	Aluminium
IP DEGREE:	IP20
FORM:	Round
IK:	IK06
LIGHT DIRECTION:	Fixed
REGULATION:	1..10V · Push · DALI · Non Dimm
BEAM ANGLE:	38°
UTILIZATION:	Indoor
WARRANTY:	5 years

## GENERAL DIMENSIONS

	20204 S : Ø56 x 57 mm
	20204 M : Ø75 x 81 mm
	20204 L : Ø100 x 114,8 mm
MAXIMUM CABLE LENGTH	3000 mm
MINIMUM DISTANCE TO ILLUMINATED OBJECT:	0.5 m

## ELECTRICAL DETAILS

LAMP:	LED
PROTECTION CLASS:	
ENERGETIC EFFICIENCY:	A++
DRIVER:	Included ( remote if dimmable )
I:	S: 500 mA M: 700 mA L: 500 mA
VOLTAGE:	220 - 240 V
LIFE TIME:	35.000 h
LUMEN MAINTENANCE:	L80_B10: 35000 h
CRI:	>90
MACADAM:	<3
UGR:	20



CE 



Let's get brighter

# KIERA

FAMILY

## ELECTRICAL DETAILS

POWER	S	M	L
WATTS:	4,5 W	7 W	18 W
EFFICIENCY			
EFF 2700K:	78 lm/w	81 lm/w	70 lm/w
EFF 3000K:	79 lm/w	82 lm/w	83 lm/w
EFF 4000K:	82 lm/w	85 lm/w	96 lm/w
LUMENS			
2700K lm:	411 lm	572 lm	1396 lm
3000K lm:	447 lm	574 lm	1655 lm
4000K lm:	488 lm	594 lm	1962 lm

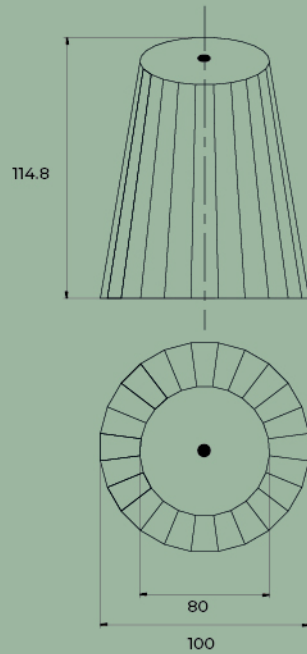

20204 L

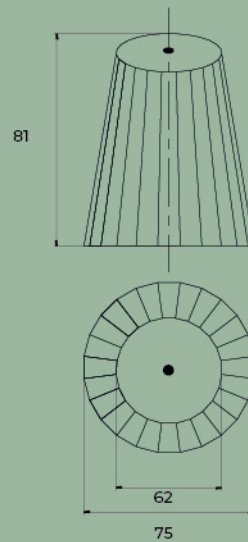

20204 M

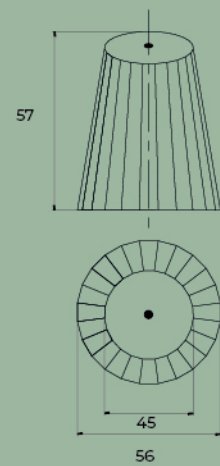

20204 S



# KIERA

FAMILY

 **BPM**Lighting®

Let's get brighter



ALBERTA

due



Let's get brighter

CE 



Let's get brighter



#### MEASURES

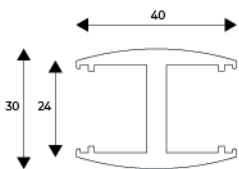
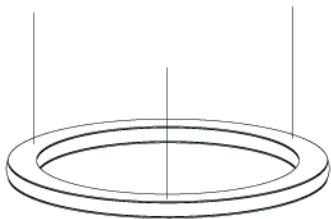

# ALBERTA

due

#### GENERAL DETAILS

REFERENCE: 10250  
INSTALLATION: Pendant  
EXTERNAL FINISH: White · Black · Anodized grey · Gold · Blue · Aqua · Red · Flamingo · Green · Orange · Pink · Copper · Gold leaf · Silver leaf

MATERIAL: Aluminium

IP DEGREE: IP40

IK: IK06

FORM: Round

LIGHT DIRECTION: Fixed

REGULATION: 1..10V · Push · DALI

OPTIC COVER: Silicone

UTILIZATION: Indoor

WARRANTY: 5 years

#### GENERAL DIMENSIONS

HEIGHT: 30 mm

EXT. DIAMETER: Ø 350 | 450 | 650 | 950 | 1250 mm

MAXIMUM CABLE LENGTH: 3000 mm

MINIMUM DISTANCE TO ILLUMINATED OBJECT: 0.5 m

#### ELECTRICAL DETAILS

LAMP: LED

LED TYPE: STRIPE LED

PROTECTION CLASS: 

ENERGETIC EFFICIENCY: A+

DRIVER: Included Remote

PF: 0.9

CONSTANT VOLTAGE: 24 V

VOLTAGE: 230 V

LIFE TIME: 35.000 h

LUMEN MAINTENANCE: L80\_B10 / 35000 h

CRI: ≥ 80

MACADAM: 3



CE 

 **BPM**Lighting®

Let's get brighter

# ALBERTA

due

## ELECTRICAL DETAILS

POWER	Ø 350	Ø 450	Ø 650	Ø 950	Ø 1250
	HI	HI	HI	HI	HI
WATTS:	28	37	56	83	110
EFFICIENCY					
EFF 2700K:	120 lm/w	120 lm/w	120 lm/w	120 lm/w	120 lm/w
EFF 3000K:	121 lm/w	121 lm/w	121 lm/w	121 lm/w	121 lm/w
EFF 4000K:	129 lm/w	129 lm/w	129 lm/w	129 lm/w	129 lm/w
INTERNAL LUMENS					
2700K lm:	3419 lm	4507 lm	6685 lm	9951 lm	13108 lm
3000K lm:	3436 lm	4531 lm	6720 lm	10003 lm	13177 lm
4000K lm:	3661 lm	4828 lm	7160 lm	10658 lm	14040 lm
EXTERNAL LUMENS					
2700K lm:	3419 lm	4507 lm	6685 lm	9951 lm	13108 lm
3000K lm:	3436 lm	4531 lm	6720 lm	10003 lm	13177 lm
4000K lm:	3661 lm	4828 lm	7160 lm	10658 lm	14040 lm

## MEASURES

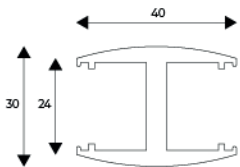
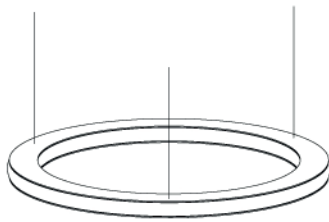
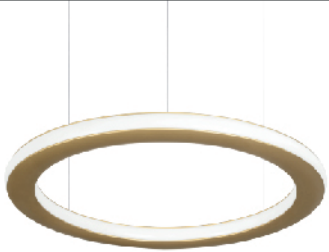

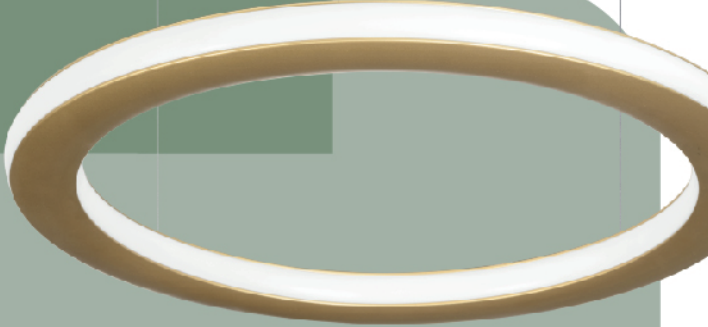
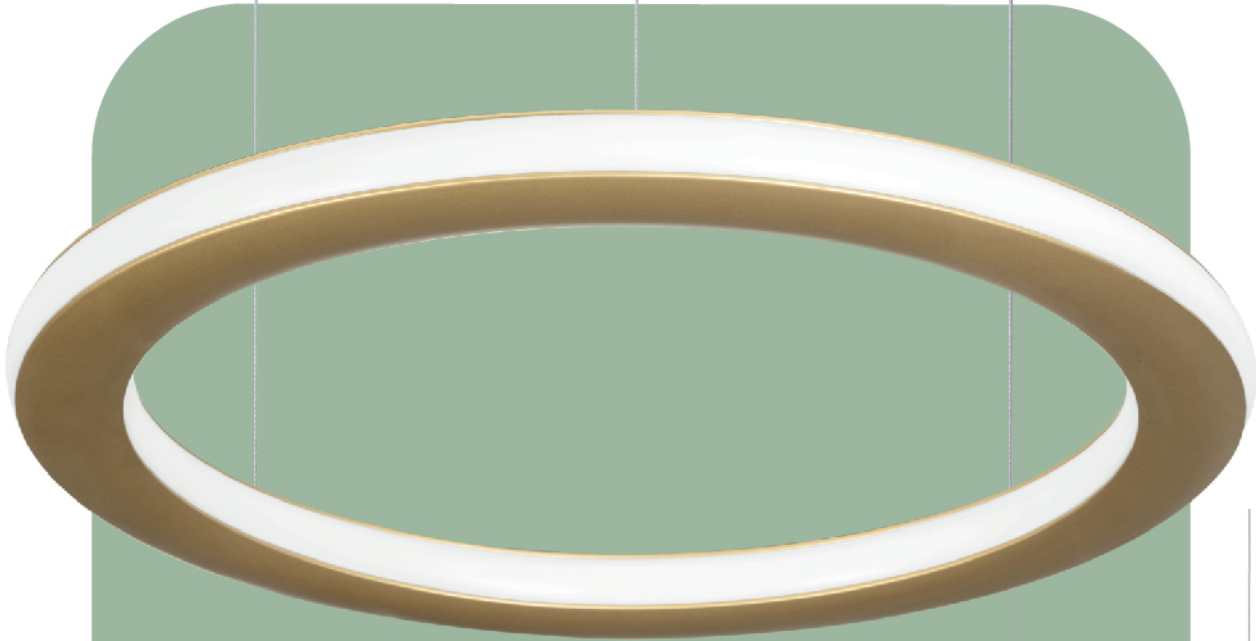

ALBERTA  
due



Let's get brighter



ALBERTA  
inside



Let's get brighter

CE 



Let's get brighter



#### MEASURES

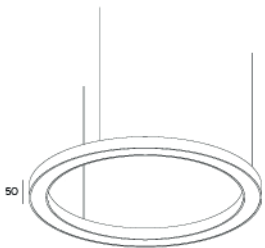

# ALBERTA

inside

#### GENERAL DETAILS

REFERENCE:	10243
INSTALLATION:	Pendant
EXTERNAL FINISH:	White · Black · Anodized grey · Gold · Blue · Aqua · Red · Flamingo · Green · Orange · Pink · Copper · Gold leaf · Silver leaf
MATERIAL:	Aluminium
IP DEGREE:	IP40
IK:	IK06
FORM:	Round
LIGHT DIRECTION:	Fixed
REGULATION:	1..10V · Push · DALI
OPTIC COVER:	Silicone
UTILIZATION:	Indoor
WARRANTY:	5 years

#### GENERAL DIMENSIONS

HEIGHT:	50 mm
EXT. DIAMETER:	Ø 350   450   650   950   1250 mm
MAXIMUM CABLE LENGTH	3000 mm
MINIMUM DISTANCE TO ILLUMINATED OBJECT:	0.5 m

#### ELECTRICAL DETAILS

LAMP:	LED
LED TYPE:	STRIPE LED
PROTECTION CLASS:	
ENERGETIC EFFICIENCY:	A+
DRIVER:	Included Remote
PF:	0.9
CONSTANT VOLTAGE:	24 V
VOLTAGE:	230 V
LIFE TIME:	35.000 h
LUMEN MAINTENANCE:	L80_B10 / 35000 h
CRI:	≥80
MACADAM:	3



CE 



Let's get brighter

# ALBERTA

inside

## ELECTRICAL DETAILS

POWER	Ø 350		Ø 450		Ø 650		Ø 950		Ø 1250	
		HI		HI		HI		HI		HI
WATTS:		27		36		54		81		109
EFFICIENCY										
EFF 2700K:		120 lm/w		120 lm/w		120 lm/w		120 lm/w		120 lm/w
EFF 3000K:		121 lm/w		121 lm/w		121 lm/w		121 lm/w		121 lm/w
EFF 4000K:		129 lm/w		129 lm/w		129 lm/w		129 lm/w		129 lm/w
LUMENS										
2700K lm:		3266 lm		4355 lm		6532 lm		9798 lm		13065 lm
3000K lm:		3283 lm		4378 lm		6567 lm		9850 lm		13133 lm
4000K lm:		3498 lm		4664 lm		6996 lm		10495 lm		13993 lm

## MEASURES

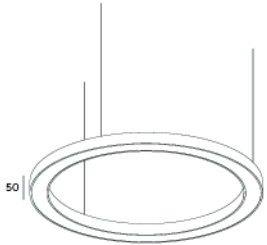

# ALBERTA

INSIDE

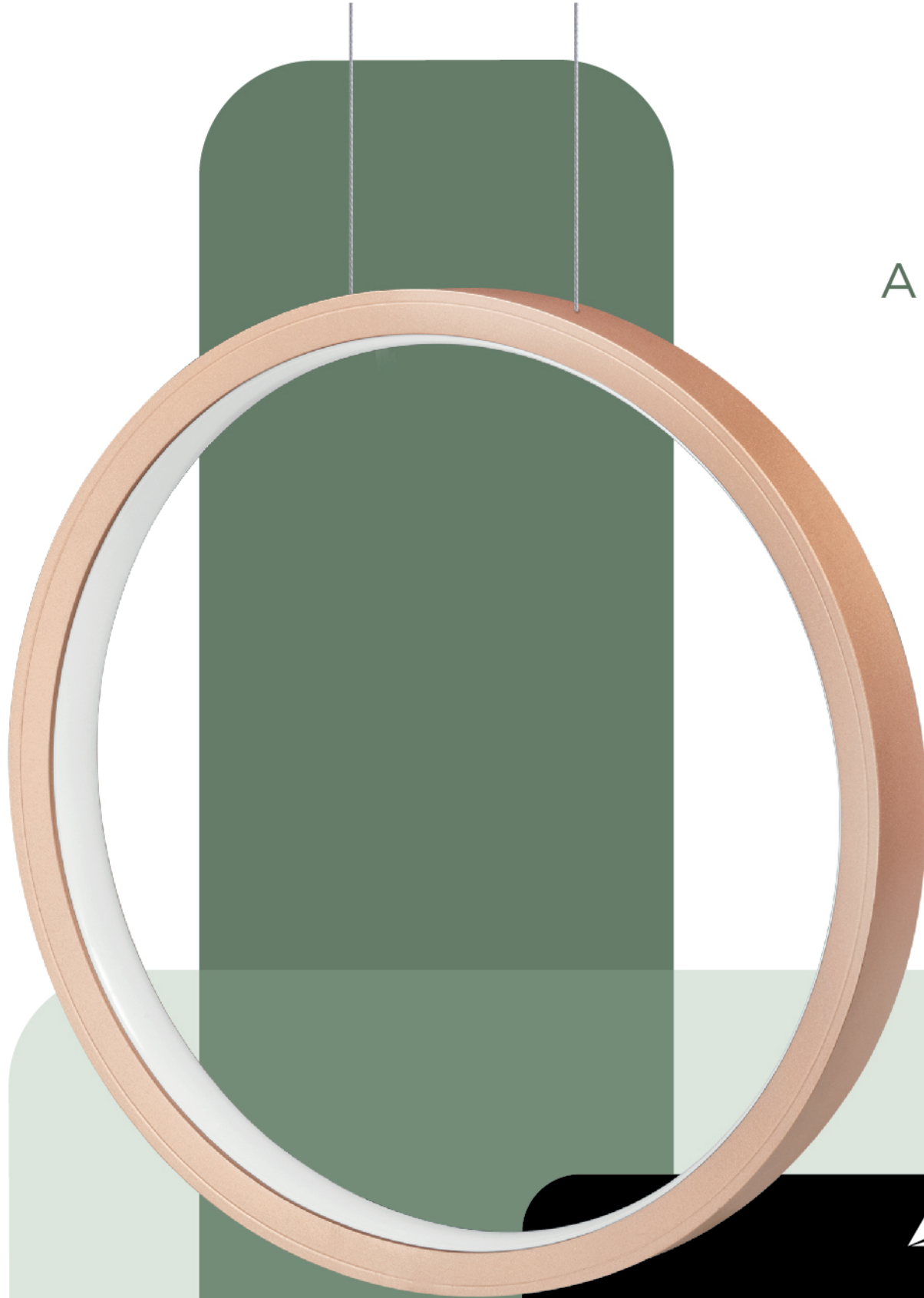

 **BPM**Lighting®

Let's get brighter



# GALANTA

EXALTS THE BEAUTY

 **BPM**Lighting®

Let's get brighter



Let's get brighter

# GALANTA

EXALTS THE BEAUTY



## GENERAL DETAILS

REFERENCE:	20221
INSTALLATION:	Pendant
EXTERNAL FINISH:	.BK Black   .W White   .SG Shiny Gold   .CH Chrome
MATERIAL:	Iron and Methacrylate
IP EXTERIOR:	IP20
FORM:	Round
IK:	IK06
LIGHT DIRECTION:	Fixed
REGULATION:	Non-dimm
UTILIZATION:	Indoor
WARRANTY:	5 years

## GENERAL DIMENSIONS

	60.5 X 60.5 X 200 mm.
MAXIMUM CABLE LENGTH	3000 mm
MINIMUM DISTANCE TO ILLUMINATED OBJECT:	0.5 m

## ELECTRICAL DETAILS

LAMP:	G9 LED
LAMP HOLDER:	G9
PROTECTION CLASS:	⊕
ENERGETIC EFFICIENCY:	A+
VOLTAGE:	220 - 240 V
LIFE TIME:	30.000 h
CRI:	90
POWER:	5 W

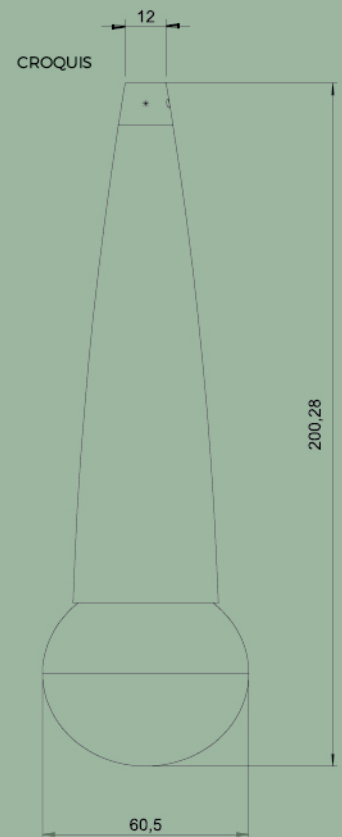





20206.03



20206.04



20206.10

# SUBLIM

The Elegance of Geometry



Let's get brighter



Let's get brighter



# SUBLIM

FAMILY

## GENERAL DETAILS

REFERENCE:	20206.03   20206.04   20206.10
INSTALLATION:	Pendant
EXTERNAL FINISH:	White · Black
MATERIAL:	Aluminium
IP DEGREE:	IP20
FORM:	Round
IK:	IK07
LIGHT DIRECTION:	Fixed
REGULATION:	1..10V · Push · DALI · Phase Cut
BEAM ANGLE:	36°
UTILIZATION:	Indoor
WARRANTY:	5 years

## GENERAL DIMENSIONS

	20206.03 : 39 X 39 X 270 mm.
	20206.04 : 39 X 39 X 400 mm.
	20206.10 : 39 X 39 X 1000 mm.
MAXIMUM CABLE LENGTH	3000 mm
MINIMUM DISTANCE TO ILLUMINATED OBJECT:	0.5 m

## ELECTRICAL DETAILS

LAMP:	LED
LED TYPE:	BRIDGELUX
PROTECTION CLASS:	ⓘ
ENERGETIC EFFICIENCY:	A+
DRIVER:	Included ( remote if dimmable )
I:	350 mA
VOLTAGE:	220 - 240 V
LIFE TIME:	50.000 h
LUMEN MAINTENANCE:	L80_B10 / 50000 h
CRI:	93
MACADAM:	<3
UGR:	<19

CE 



Let's get brighter

# SUBLIM

FAMILY

## ELECTRICAL DETAILS

POWER	
WATTS:	9 W
EFFICIENCY	
EFF 2700K:	62 lm/w
EFF 3000K:	62 lm/w
EFF 4000K:	68 lm/w
LUMENS	
2700K lm:	469 lm
3000K lm:	482 lm
4000K lm:	495.3 lm

## MEASURES (mm.)

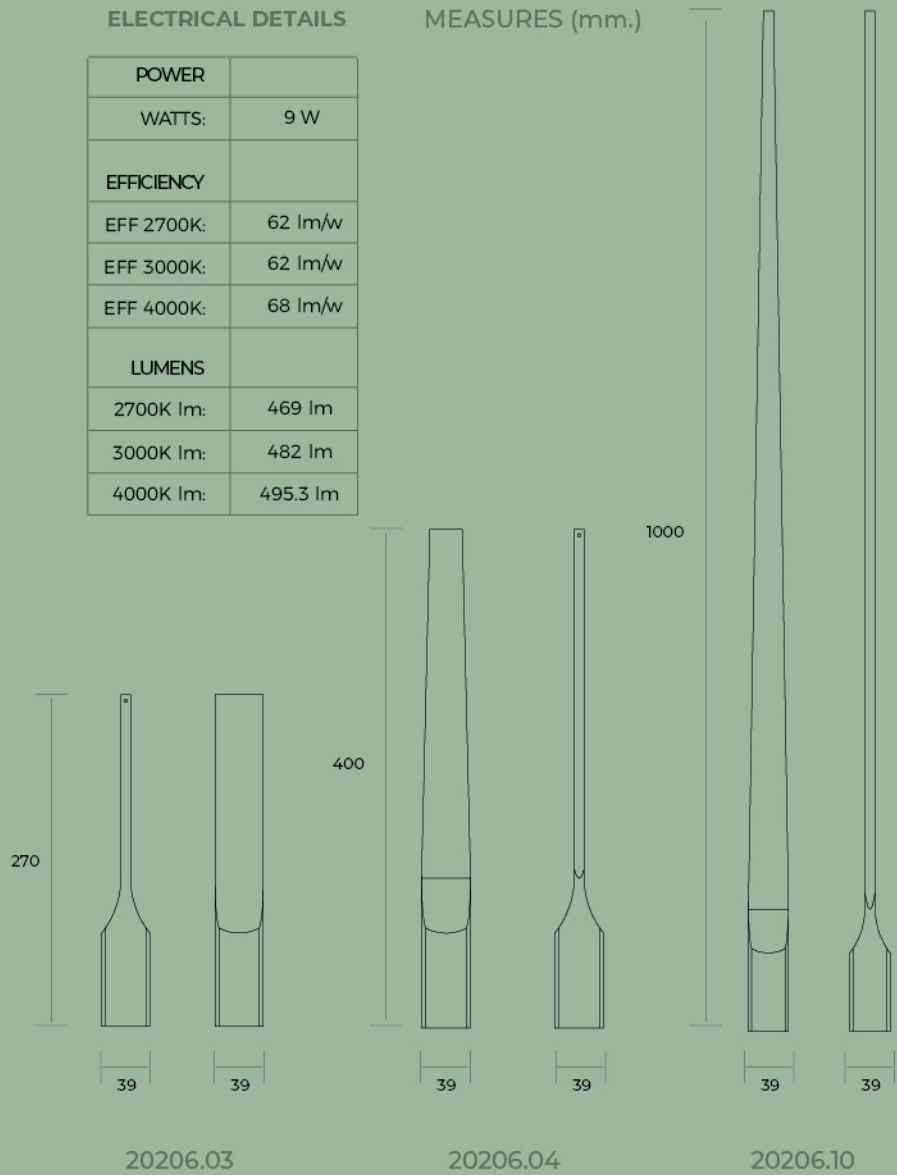

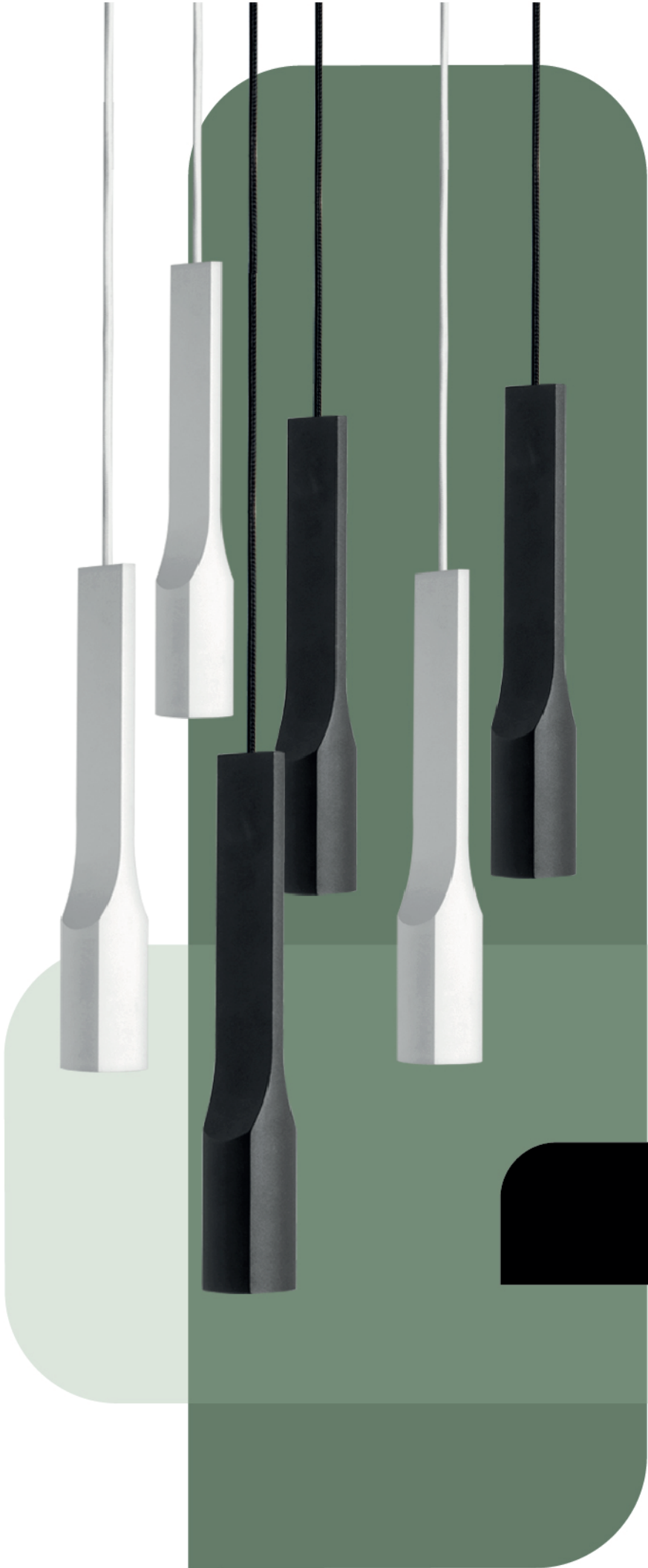

# SUBLIM

 **BPM**Lighting®

Let's get brighter



 **BPM**Lighting®

Let's get brighter

## Let's play

Versatility. Adding or removing magnetic accessories to achieve the desired atmosphere. Playing with light has never been so simple.





Let's get brighter