

AVANT-GARDE DESIGN

DECORATIVE PROFILES

for your interior

MARDOM
DECOR



Autorami wizualizacji z użyciem produktów Mardom Decor są biura architektoniczne:

- OSOM Group www.osomgroup.pl

- Bluetarpan www.bluetarpan.com

- 005** | **O firmie**
About us
Über uns
À propos de nous
- 008** | **Legenda**
Legend
Legende
Légende
- 009** | **Listwy elastyczne**
Flexible mouldings
Flexible Leisten
Moulures souples
- 010** | **Dlaczego warto wybrać listwy Mardom Decor?**
Why choose Mardom Decor mouldings?
Warum Mardom Decor leisten wählen?
Pourquoi choisir les plinthes Mardom Decor?
- 012** | **Technologia LightGuard**
LightGuard technology
LightGuard technologie
Technologie LightGuard
- 014** | **Vivid by Studio Rygalik**
- 016** | **Mardom Decor Atelier**
- 018** | **Listwy karniszowe**
Curtain profiles
Gardinenleisten
Corniches cache rideaux
- 024** | **Listwy przypodłogowe**
Skirting
Sockelleisten
Plinthes blanches
- 032** | **Listwy ścienne**
Wall mouldings
Wandprofile
Les moulures murales
- 034** | **Listwy ścienne gładkie**
Plain wall mouldings
Flache wandleisten
Moulures lisses
- 040** | **Listwy ścienne ornamentacyjne**
Ornamented wall mouldings
Wandleisten mit ornamenten verziert
Moulures avec onementation
- 042** | **Listwy sufitowe**
Cornice mouldings
Deckenleisten
Les moulures de plafond
- 044** | **Listwy sufitowe gładkie**
Plain cornice mouldings
Flache deckenleisten
Corniches lisses
- 051** | **Listwy sufitowe ornamentacyjne**
Ornamented cornice mouldings
Wandleisten mit ornamenten verziert
Corniches avec ornementation
- 054** | **Listwy oświetleniowe**
Lighting mouldings
Lichtleisten
Corniches d'éclairage
- 060** | **Dekoracje**
Decorative elements
Zierelemente
Éléments décoratifs
- 062** | **Narożniki**
Corners
Ecken mit Wandleisten
Éléments d'angles de moulures
- 064** | **Rozety**
Ceiling roses
Rosetten
Rosaces
- 067** | **Kolumny**
Columns
Säulen
Colonnes
- 071** | **Półkolumny**
Half Columns
Halbsäulen
Colonnes
- 075** | **Pilastry**
Pilasters
Pilaster
Pilastres
- 083** | **Elementy dekoracyjne**
Decorative elements
Zierelemente
Éléments décoratifs
- 085** | **Obramowania**
Frames
Türumrandungen
Bordure
- 088** | **Aksesoria**
Accessories
Zubehör
D'accessoires
- 094** | **Materiały marketingowe**
Marketing materials
Marketing-Materialien
Matériel promotionnel
- 098** | **Instrukcja montażu**
Installation
Installation
Installation
- 102** | **Informacje techniczne**
Technical Info
Technische Informationen
Informations techniques



1. B3025

2. MDD332

3. MDB169

4. MD094

PL

Mardom Decor to jedna z wiodących marek produkujących listwy dekoracyjne i sztukaterię. Produkty wykonane są z najwyższej jakości wodoodpornych materiałów, co gwarantuje perfekcyjny wygląd listew przez wiele lat. W asortymencie znajdują się setki wzorów, kreowanych we współpracy ze znanymi projektantami przemysłowymi. Tworzymy produkty dedykowane do wszystkich stylów wnętrzarskich – od minimalizmu i prostych form, do bogatych, klasycznych zdobień. Produkty Mardom Decor cieszą się uznaniem klientów - właśnie dlatego, zostały nagrodzone w wielu prestiżowych konkursach branżowych.

DE

Mardom Decor ist einer der führenden Markenhersteller von dekorativen und besonders schönen Stuckelementen. Unsere Produkte werden aus den hochwertigsten Materialien hergestellt und sind gegen Wasser resistent. Dies garantiert die perfekte Optik über viele Jahre. Das Sortiment umfasst Hunderte von Designs, die in Zusammenarbeit mit namenhaften und renommierten Designern entstanden sind. Wir entwickeln Produkte für alle Einrichtungsstile - vom Minimalismus und einfachen Formen bis hin zu reichen und klassischen Dekorationen. Die Produkte von Mardom Decor werden von den Kunden geschätzt, weshalb sie bei vielen renommierten Branchenwettbewerben auch ausgezeichnet werden.

EN

Mardom Decor is one of the leading brands producing decorative mouldings and stuccowork. The products are made of the highest quality waterproof materials, which guarantees the perfect appearance of the mouldings for many years. The assortment includes hundreds of designs, created in cooperation with renowned industrial designers. We create products dedicated to all interior styles - from minimalism and simple forms to rich, classic decorations. Mardom Decor products are appreciated by customers, which is why they have been awarded in many prestigious industry competitions.

FR

Mardom Decor est un des principaux fabricants de moulures décoratives et stuc. Les produits sont fabriqués à partir de matériaux imperméables de la plus haute qualité, et garantissent un aspect parfait des moulures pendant de nombreuses années. L'offre comprend des centaines de modèles créés en collaboration avec des designers industriels renommés. Nous créons des produits dédiés à tous les styles d'intérieur - du minimalisme avec des formes simples, à des aspects classiques riches en décors. Les Produits Mardom Decor sont appréciés des clients - et ont été récompensé lors de nombreux concours prestigieux de l'industrie.



reddot award 2016
winner

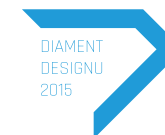

2 RODZAJE MATERIAŁÓW

2 TYPES OF MATERIALS | 2 ARTEN VON MATERIALIEN | 2 TYPES DE MATÉRIAUX

PL Produkty Mardom Decor wykonywane są z 2 rodzajów materiału: PolyForce® oraz ProFoam®. Każdy z nich ma swoje cechy i zastosowanie, ale łączy je jedno. Oba są wodoodporne i będą służyć Ci przez wiele lat.

EN Mardom Decor products are made of 2 types of material: PolyForce® and ProFoam®. Each of them has its own characteristics and uses, but they have one thing in common. Both are waterproof and will serve you for many years.

DE Mardom Decor Produkte bestehen aus 2 verschiedenen Materialarten: PolyForce® und ProFoam®. Jeder von ihnen hat seine eigenen Eigenschaften bei Nutzung und Verwendung, aber eines haben sie gemeinsam. Sie sind wasserdicht und werden Dir viele Jahre lang dienen.

FR Les produits Mardom Decor sont composés de 2 types de matériaux: le PolyForce® et le ProFoam®. Chacun d'entre eux possède ses propres caractéristiques, mais ont un point commun. Tous deux sont hermétiques et resteront en place de nombreuses années.

Materiał Material Material Matériau	Trwałość Durability Langlebigkeit Durabilité	Gęstość Density Dichte Densité	Ciężkość Weight Gewicht Poid	Wodoodporność Waterproof Wasserfest Imperméabilité	Pokryty farbą podkładową Primed Vorgrundiert Recouvert d'un primaire d'accrochage	Możliwość podświetlenia LED Dedicated for LED Für LED geeignet Possibilité d'éclairage LED	Długość listwy Length Länge Longeur des moules
PolyForce®	●●●●●	●●●●●	●●●●●	●●●●●	✓	✓	200 cm*
ProFoam®	●●●●○	●●●○○	●●●○○	●●●●●	✓	✓	240 cm

*Niektóre listwy karniszowe wykonane są z PolyForce i mają długość 240 cm. Zobacz na stronie 22.

*Some mouldings for curtain rails are made of PolyForce and are 240 cm long. See page 22.

*Einige der Leisten sind aus PolyForce gefertigt und haben eine Länge von 240 cm. Siehe Seite 22.

*Certaines corniches cache tringles à rideaux sont en PolyForce et mesurent 240 cm de long. Voir en page 22.



PL Pod zdjęciem każdego produktu znajdziesz informację z jakiego materiału jest wykonany.

EN Under the photo of each product you will find information about the material of its making.

DE Unter den Produktfotos finden Sie jeweils die Information, aus welchem Material das Produkt besteht.

FR Sous la photo de chaque produit, vous trouverez des informations sur le matériau dont il est constitué.

2 RODZAJE WYKOŃCZEŃ LISTEW PRZYPODŁOGOWYCH

2 TYPES OF SKIRTING FINISHES | 2 MÖGLICHKEITEN VON ANSTRICHEN | 2 TYPES DE FINITIONS DE PLINTHES

MARDOM
DECOR *Premium*[®]

PL Listwy przypodłogowe Mardom Decor występują w dwóch wykończeniach - standardowym matowym oraz ekskluzywnym satynowym. Mardom Decor Premium to kolekcja satynowych, wodoodpornych listew przypodłogowych, które nie wymagają malowania. Pokryte są ekskluzywną powłoką, która nadaje listwom satynowe wykończenie, idealną gładkość i śnieżną biel. Ich montaż polega tylko na przyklejeniu listwy do ściany - bez konieczności późniejszego malowania ich farbą. Listwy Mardom Decor Premium są wodoodporne, dzięki czemu możesz stosować je w łazience i kuchni. Oprócz najwyższej trwałości i funkcjonalności, listwy zachwycają pięknym wyglądem. To najwyższy poziom w wykańczaniu wnętrz. Listwy Mardom Decor Premium oznaczane są symbolem „P” np. „MD234P” (zobacz na stronach 26-30).

EN Mardom Decor skirting boards come in two finishes – the standard matte and the exclusive satin. Mardom Decor Premium is a collection of satin, water-resistant skirting boards that do not require painting. They are finished with exclusive coating that gives the boards satin look, perfect smoothness and snow whiteness. Their fixture consists merely of sticking the board to the wall – with no subsequent painting needed. Mardom Decor Premium skirting boards are water-resistant, making them suitable for use in bathroom or kitchen. Adding to its exceptional durability and functionality, the product impresses with its beautiful looks. This is the premium level of interior decoration. Mardom Decor Premium boards are designated with the “P” symbol, e.g. “MD234P” (see pages 26-30).

DE Die Sockelleisten von Mardom Decor sind in zwei Varianten erhältlich. Zum einen in Standard matt weiß vorgrundiert und zum anderen in der Premiumqualität. Mardom Decor Premium besitzt eine fertig lackierte, satinierte, weiße, wasserfeste Beschichtung. Somit ist keine Endlackierung notwendig. Die Oberfläche ist extrem glatt und schneeweiß im Farbton. Das heißt die Sockelleisten müssen nur montiert/geklebt werden und der Arbeitsgang „Endlackierung“ entfällt. Mardom Decor Premium ist wasserfest und somit für alle Nassräume geeignet. Kein Aufquellen wie bei herkömmlichen MDF-Produkten! Das hochwertige Erscheinungsbild, sowie die Funktionalität vereint diese Innovation zur höchsten Stufe im Premiumsektor der Raumgestaltung. Mardom Decor Premium Leisten sind mit dem Symbol „P“ gekennzeichnet. Z.B.: MD234P (siehe Seiten 26-30).

FR Les plinthes Mardom Decor sont disponibles en deux finitions: mate en standard et satinée exclusive. Mardom Decor Premium est une collection de plinthes satinées et imperméables qui ne nécessitent pas de peinture. Elles sont recouvertes d'un revêtement exclusif qui donne aux plinthes une finition satinée, d'une douceur parfaite et d'un blanc brillant. Leur assemblage consiste uniquement à coller la moulure au mur - sans avoir besoin de les peindre ultérieurement. Les plinthes Mardom Decor Premium sont imperméables, vous pouvez donc les utiliser dans la salle de bain et la cuisine. En plus de leur durabilité et de leur fonctionnalité des plus élevées, les plinthes apportent avec une belle apparence. Il s'agit du plus haut niveau de finition intérieure. Les plinthes Mardom Decor Premium sont marquées du symbole „P”, par exemple „MD234P”, (voir pages 26-30).

Rodzaj wykończenia Type of finish Art der Fertigstellung Type de finition	Luksusowy wygląd Luxurious appearance Luxuriöses Erscheinungsbild Aspect luxueux	Malowanie Painting Lackierung La peinture	Maskowanie łączeń Finishing joints Endverbindungen Masquage des jonctions
Mat Mat Matt Mat	●●●○○	Sugerujemy pomalowanie listwy dowolną farbą na bazie wody. We suggest painting the skirting board with any water-based paint. Wir empfehlen, die Leisten mit einer wasserbasierten Farbe zu lackieren. Vous pouvez peindre la plinthe avec n'importe quelle peinture à l'eau.	Użyj kleju Mardom Decor Fix Extra (s. 92). Use Mardom Decor Fix Extra adhesive (see page 92). Verwenden Sie den Kleber Mardom Decor Fix Extra (siehe Seite 92). Utilisez la colle Mardom Decor Fix Extra (page 92).
Satyna Satin Satinée	●●●●●	Nadaje się do bezpośredniego montażu. Suitable for direct installation. Geeignet für direkte Montage. Convient pour un montage immédiat.	Użyj lakieru Mardom Decor Premium (s. 92). Use Mardom Decor Premium lacquer (see page 92). Verwenden Sie den Lack Mardom Decor Premium (siehe Seite 92). Utilisez le vernis Mardom Decor Premium (page 92).

PL

PolyForce®

Produkty wykonane z PolyForce® - bardzo trwałego, ekologicznego materiału o wysokiej gęstości, odpornego na uszkodzenia mechaniczne.

ProFoam®

Produkty wykonane z ProFoam® - twardego i jednocześnie lekkiego materiału o gęstości umożliwiającej tworzenie ostrych i głębokich zdobień.

SupremeSatin®

Na specjalnie życzenie, listwy podłogowe są dodatkowo pokrywane ekskluzywnym lakierem SupremeSatin®, zapewniającym satynową głębię, śnieżną biel i idealną gładkość.



Produkt pokryty primerem, o właściwościach wyglądających i ułatwiających przyjęcie farby.

Flex

Produkt dostępny w wersji elastycznej, przeznaczony do stosowania na półokrągłych lub nierównych ścianach. Listwy podłogowe Flex mają długość 200 cm. Listwy ściennie oraz sufitowe Flex mierzą 240 cm.

LED

Produkt dedykowany do stosowania z oświetleniem LED. Dla idealnego efektu zalecamy oklejenie listwy oświetleniowej od wewnętrznej strony taśmą aluminiową Mardom Decor Alu Tape.

ScratchShield®

Listwy przypodłogowe poddawane są wielu codziennym wyzwaniom. Doskonale to wiemy. Właśnie dlatego, opracowaliśmy innowacyjną technologię ScratchShield, która polega na ekstremalnym utwardzeniu listwy przypodłogowej. Różnica jest ogromna i zauważalna przy próbie zarysowania listwy ostrym narzędziem. Twardość listew z technologią ScratchShield jest o 24% większa niż standardowych listew. Pomiar twardości wykonywany jest twardościomierzem i wyrażony w skali Shore'a.

EN

Products made of PolyForce® – a very durable, ecological material with high density and resistance to mechanical damage.

Products made of ProFoam® - a hard yet lightweight material with a density enabling the creation of sharp and deep adornments.

On special request, the product is additionally coated with exclusive SupremeSatin® lacquer, providing satin depth, snow white and perfect smoothness. It is easy to remove any impurities from the coating.

The product is covered with a primer, making it smooth and allowing easy absorption of paint.

Product available in the flexible version, intended for use on half-rounded or uneven walls. The Flex skirting boards have a length of 200 cm. The Flex panel mouldings and cornice mouldings have a length of 240 cm.

Product designed for use with LED lighting. For a perfect effect, we recommend gluing lighting moulding on the inside with Mardom Decor Alu Tape.

Skirting boards are subject to many daily challenges. We know this perfectly well. That's why we have developed the innovative ScratchShield technology, which consists in extremely hardening our skirting boards. The difference is huge and noticeable when trying to scratch the skirting board with a sharp tool. The hardness of skirting boards with ScratchShield technology is 24% higher than standard skirting boards. The hardness is measured with a hardness meter and expressed in Shore scale.

DE

Produkte aus PolyForce® - ein sehr langlebiges, umweltfreundliches Produkt mit hoher Dichte und Beständigkeit gegen mechanische Beschädigungen.

Produkte aus ProFoam®- einem harten und dennoch leichten Material mit einer Dichte, die die Herstellung von scharfen und tiefen Ornamenten ermöglicht.

Auf besonderen Wunsch werden die Sockelleisten zusätzlich mit dem exklusiven Lack SupremeSatin® beschichtet, der für Satintiefe, schneeweißes Weiß und perfekte Geschmeidigkeit / Glätte sorgt.

Ein mit Grundierung beschichtetes Produkt mit Glättungs- und leichter Farbaufnahmeeigenschaft.

Das Produkt ist in flexibler Ausführung erhältlich und für den Einsatz an halbrunden oder unebenen Wänden vorgesehen. Die Flex-Sockelleisten haben eine Länge von 200 cm. Die Flex-Wand- und Deckenleisten haben eine Länge von 240 cm.

Dieses Produkt ist für den Einsatz mit LED-Beleuchtung vorgesehen. Für einen perfekten Effekt empfehlen wir, das Lichtband auf der Innenseite mit Mardom Decor Alu Tape anzubringen.

Sockelleisten sind einer täglichen hohen Belastung ausgesetzt. Ob es die neuen Staubsaugerroboter sind oder das normale alltägliche Säubern. Jeder kennt die Kratz- und Stoßspuren an den Fußleisten. Damit ist jetzt schluss! Mit der neuen und einzigartigen ScratchShield Technologie hat Mardom Decor eine extrem hochwertige und robuste Oberfläche geschaffen, welche jeder Beanspruchung stand hält. Die Kratzfestigkeit ist 24% höher als bei vergleichbaren Produkten! Die Härtemessung wird mit einem Härtemessgerät gemessen und in der Shore-Skala ermittelt.

FR

Les Produits fabriqués à partir de PolyForce® - un matériau durable et écologique à haute résistance au poinçonnement.

Produits fabriqués à partir de ProFoam® - dense et léger permettant la création de décorations aux reliefs précis et profonds.

Sur demande, il est possible d'appliquer une couche supplémentaire de vernis exclusif SupremeSatin®, offrant une finition satinée, un effet « blanc comme neige » et douceur parfaite.

Les produits sont recouverts d'un primaire d'acroschage aux propriétés lissantes et facilitant l'imprégnation de la peinture.

Les produits sont recouverts d'un primaire d'acroschage aux propriétés lissantes et facilitant l'imprégnation de la peinture.

Produit dédié pour une utilisation avec un éclairage LED. Pour un effet parfait, nous recommandons d'appliquer coté intérieur de la corniche d'éclairage un ruban Mardom Decor Alu.

Les plinthes font face à de nombreux défis quotidiens. Nous le savons parfaitement bien. C'est pourquoi nous avons développé la technologie innovante ScratchShield, qui repose sur le durcissement extrême de la plinthe. La différence est énorme et perceptible lorsque vous essayez de gratter la plinthe avec un outil pointu. La dureté des lames dotées de la technologie ScratchShield est 24% supérieure à celle des lames standard. La mesure de la dureté est réalisée avec un duromètre et exprimée sur l'échelle Shore.

listwy

E L A S T Y C Z N E

Flexible mouldings

Flexible Leisten

Moulures souples



PL

Potrzebujesz zamontować listwę na półokrągłej ścianie? Nierówności uniemożliwiają Ci montaż prostej listwy? W takich sytuacjach najlepiej sprawdzą się listwy elastyczne. Wykonane są ze specjalnego, giętkiego tworzywa. Listwy malujemy dopiero po zamontowaniu, po to, aby uniknąć popękania powłoki farby.

EN

Do you need to install the moulding on a semicircular wall? Unevenness prevents you from installing a straight moulding? In such situations, flexible profiles are the best solution. They are made of a special, flexible material. The mouldings should be painted only after installation in order to avoid cracking of the paint coating.

DE

Möchten Sie die Sockelleiste an einer halbrunden Wand montieren? Unebenheiten verhindern, dass Sie eine einfache Sockelleiste anbringen können? In solchen Situationen sind flexible Sockelleisten die beste Lösung. Sie sind aus einem speziellen, flexiblen Material gefertigt. Die Sockelleisten sollten erst nach der Montage lackiert werden, um Risse in der Lackschicht zu vermeiden.

FR

Avez-vous besoin de monter une moulure sur un mur semi-circulaire? Des irrégularités vous empêchent d'installer une moulure droite? Les moulures flexibles sont la meilleure solution dans de telles situations. Elles sont fabriqués dans un matériau spécial et flexible. Nous ne peignons les bandes qu'après l'installation afin d'éviter de fissurer le revêtement de peinture.

DLACZEGO WARTO WYBRAĆ LISTWY MARDOM DECOR?

WHY CHOOSE MARDOM DECOR MOULDINGS? | WARUM MARDOM DECOR LEISTEN WÄHLEN? | POURQUOI CHOISIR LES PLINTHES MARDOM DECOR?



ŁATWY MONTAŻ

EASE OF INSTALLATION | LEICHTE MONTAGE | MONTAGE SIMPLE

PL

Produkty są łatwe w obróbce i montażu. Mardom Decor oferuje akcesoria dodatkowo ułatwiające ten proces (strona 88).

ENG

The products are easy to cut and install. Mardom Decor offers accessories that facilitate this process (page 88).

DE

Die Produkte sind einfach zu verarbeiten und zu montieren. Mardom Decor bietet zusätzlich auch das Zubehör, um diesen Prozess zu erleichtern (Seite 88).

FR

Les produits sont faciles à utiliser et à installer. Mardom Decor propose des accessoires qui facilitent davantage la pose (page 88)



POKRYTE PRIMEREM

COVERED WITH PRIMER | GRUNDIERT MIT EINEM PRIMER | RECOUVERT D'UN PRIMAIRE D'ACCROCHAGE

PL

Wszystkie listwy pokryte są specjalnym, zabezpieczającym primerem, ułatwiającym absorpcję farby.

ENG

All mouldings are covered with a special protective primer, which facilitates paint absorption.

DE

Alle Leisten sind mit einer speziellen Schutzgrundierung versehen, die die Lackaufnahme erleichtert.

FR

Toutes les moulures sont recouvertes d'un primaire d'accrochage spéciale, facilitant l'absorption de peinture

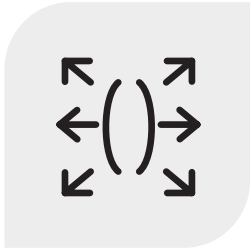

ODPORNE NA PĘCZNIENIE

SWELLING RESISTANCE | QUELLBESTÄNDIG | RÉSISTANCE À LA DILATATION

PL

Listwy Mardom Decor, w przeciwieństwie do listew wykonanych z MDF, nie ulegają odkształcaniu, rozwarstwianiu i pęcznieniu pod wpływem wilgoci.

ENG

Mardom Decor mouldings, unlike MDF products, do not undergo deformation, delamination and swelling under the influence of moisture.

DE

Produkte von Mardom Decor verformen sich nicht und quellen im Gegensatz von MDF Leisten auch unter dem Einfluss von Feuchtigkeit nicht auf.

FR

Les moulures Mardom Decor, contrairement aux moulures en MDF, ne se déforment et dilatent pas sous l'effet de l'humidité.



WODOODPORNE MATERIAŁY

WATERPROOF MATERIALS | WASSERDICHTE MATERIALIEN | MATÉRIAUX IMPERMÉABLES

PL

Produkty są wodoodporne, dlatego mogą być montowane w pomieszczeniach o podwyższonej wilgotności.

ENG

The products are waterproof, so they can be installed in rooms with increased humidity.

DE

Die Produkte sind wasserdicht, so dass sie in Räumen mit erhöhter Luftfeuchtigkeit eingesetzt werden können.

FR

Les produits sont hermétiques, et peuvent donc être montés dans des pièces humides.

LightGuard®

INNOWACYJNE ROZWIĄZANIE DLA LISTEW OŚWIETLENIOWYCH

INNOVATIVE SOLUTION FOR LIGHTING MOULDINGS | INNOVATIVE LÖSUNG FÜR LICHTLEISTEN | UNE SOLUTION INNOVANTE POUR LES BANDES LUMINEUSES

PL Listwy oświetleniowe Mardom Decor posiadają unikalną technologię LightGuard® zapobiegającą przebijaniu światła przez powierzchnię listwy. Efekt przebijania światła jest zjawiskiem naturalnym, jednak znacznie wpływającym na niekorzystny efekt wizualny podświetlonej listwy. Do tej pory, aby go wyeliminować, konieczne było oklejanie listwy od wewnętrznej strony taśmą aluminiową. Listwy z technologią LightGuard® całkowicie rozwiązały ten problem. Światło idealnie rozprasza się wokół listwy, bez punktowych widocznych przebiegów na jej powierzchni.

EN Mardom Decor lighting moldings feature the unique LightGuard® technology that completely eliminates the piercing of LED light through the molding surface. The effect of light piercing is a normal phenomenon, but significantly affects the adverse visual effect of the illuminated molding. Until now, in order to eliminate it, it was necessary to tape the molding on the inside with aluminium tape. Moldings with LightGuard® technology have completely solved this problem. The light is perfectly dispersed around the molding and does not shine through anywhere on its surface.

DE Die Lichtleisten von Mardom Decor zeichnen sich durch die in der Branche einzigartige LightGuard® Technologie aus. Bisher mussten alle Lichtleisten zwecks Durchscheinen der Lichtquelle mit einem Aluminiumband versehen werden. Dieses Aluminiumband ist nicht nur aus umweltverträglichen Gesichtspunkten bedenklich, sondern in erster Linie auch ein zusätzlicher Arbeitsaufwand (das Bekleben des Alu-Bands auf die Leisten). Diese neue LightGuard Technologie ist ein Meilenstein in der Lichtleistenproduktion. Nur Produkte von Mardom Decor sind mit LightGuard® ausgestattet. Keine Lichtpunkte mehr, welche durch die Leisten scheinen. Das Licht wird gleichmäßig verteilt.

FR Les moulures d'éclairage Mardom Decor sont dotées de la technologie unique LightGuard® qui élimine complètement le perçage de la lumière LED à travers la surface des moulures. L'effet du perçage de la lumière est un phénomène normal, mais affecte défavorablement l'effet visuel des moulures d'éclairage. Jusqu'à présent, pour l'éliminer, il était nécessaire de coller à l'intérieur de la moulure un ruban aluminium. La technologie LightGuard® a complètement résolu ce problème. La lumière est parfaitement dispersée autour de la moulure et ne brille nulle part sur sa surface.



LISTWA STANDARDOWA

STANDARD MOULDING
STANDARD-LEISTE
PLINTHE STANDARD

LISTWA Z TECHNOLOGIĄ LIGHTGUARD

MOULDING WITH LIGHTGUARD TECHNOLOGY
LEISTE MIT LIGHTGUARD-TECHNOLOGIE
PLINTHE AVEC TECHNOLOGIE LIGHTGUARD



PL Każda listwa z technologią LightGuard posiada oznaczenie

EN Each molding with LightGuard technology has a marking

DE Jede Leiste mit der LightGuard® Technologie besitzt die Erkennung

FR Chaque moulure dotée de la technologie LightGuard est marquée

LightGuard



VIVID by TOMEK RYGALIK

PL

Kolekcja VIVID to najnowszy, autorski projekt jednego z najwybitniejszych projektantów przemysłowych - Tomka Rygalika. Kolekcja składa się z trzech listew o uniwersalnym zastosowaniu. Mogą być używane jako klasyczne listwy przypodłogowe, ścienne i sufitowe. Listwy pokryte są warstwą podkładową, dzięki czemu są idealnie gładkie i przygotowane na przyjęcie farby w różnych kolorach. Listwy mogą być również montowane pionowo - tworząc modne panele ścienne na kształt nowoczesnej boazerii.

ENG

The VIVID collection is the latest, original design of one of the most outstanding industrial designers - Tomek Rygalik. The collection consists of three universal profiles. They can be used as classic board, wall and ceiling mouldings. The mouldings are covered with a base layer, thanks to which they are perfectly smooth and ready to painting in different colors. Mouldings can also be mounted vertically - creating then fashionable wall panels in the shape of modern paneling.

DE

Die VIVID-Kollektion ist das neueste, originelle Design eines der herausragendsten Industriedesigner - Tomek Rygalik. Die Kollektion besteht aus drei universellen Profilleisten. Sie können als klassische Boden-, Wand- und Deckenleisten multifunktional eingesetzt werden. Die Profilleisten sind bereits grundiert, haben eine glatte Oberfläche und können individuell nach Wunsch überstrichen werden. Die Profilleisten können auch vertikal montiert werden - so entstehen modische Wandpaneele in Form von außergewöhnlichen Vertäfelungen.

FR

La collection VIVID est le dernier projet original de l'un des designers industriels les plus remarquables - Tomek Rygalik. La collection se compose de trois moulures universelles. Elles peuvent être utilisés comme plinthes, cimaises ou corniches. Les moulures sont recouvertes d'une couche d'apprêt, ce qui les rend parfaitement lisses et prêtes à recevoir de la peinture de différentes couleurs. Les moulures peuvent également être montées verticalement - créant des panneaux muraux tendance sous forme de boiserie.

NEW



QL022

200 x 2 x 1 cm

PolyForce® 



NEW



QL023

200 x 4 x 1,9 cm

PolyForce® 



NEW



MD016

200 x 10 x 2,3 cm

PolyForce® *SupremeSatin*® 

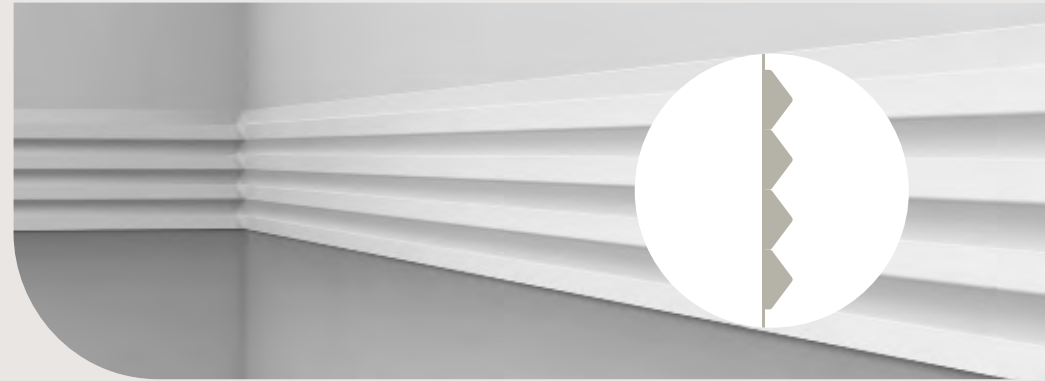



MARDOM
DECOR

Atelier[®]

PL

Mardom Decor Atelier jest odpowiedzią na wyjątkowe potrzeby naszych klientów, dla których opracowujemy oryginalne i innowacyjne projekty. Elastycznie dostosowujemy się do indywidualnych wizji i oczekiwań, tworząc sztukaterię skrojoną na Twoją miarę. Masz pomysł na autorski kształt listwy? Chcesz pomalować listwę na dowolny kolor z wzornika NCS? Wykonamy to dla Ciebie!

DE

Mardom Decor Atelier ist die Antwort auf die außergewöhnlichen Anforderungen für Planer und Architekten. Sie planen individuelle und innovative Projekte und haben eine genaue Vorstellung wie Ihre Leisten aussehen sollen? Wir können Ihre Entwürfe auf Anfrage realisieren. Gerne lackieren wir ab einer bestimmten Menge Ihre Leisten in jedem beliebigen Farbton aus der NCS-Farbtonpalette.

EN

Mardom Decor Atelier responds to the individual needs of our customers for whom we develop original and innovative designs. We aim at adapting to the vision and expectations of the clients, creating stuccowork tailored to your needs. Do you have an idea for the original shape of the molding? Do you want to paint the molding in any color from the NCS palette? We will do it for you!

FR

Mardom Decor Atelier est une réponse aux besoins uniques de nos clients, pour lesquels nous développons des projets originaux et innovants. Nous nous adaptions avec souplesse aux visions et attentes individuelles, en créant des moulures adaptées à vos besoins. Vous avez une idée pour une forme originale de moulures ? Vous voulez peindre la moulure dans n'importe quelle couleur du nuancier NCS? Nous le ferons pour vous!

listwy

KARNISZOWE

Curtain Profiles | Gardinenleisten
| Les corniches



1. QL116

2. MD003

3. MD095

LISTWY KARNISZOWE

innovacyjne rozwiązanie ukrycia karniszy

Curtain profiles - innovative solution for curtain systems

Gardinenleisten - die innovative lösung für gardinen und dekovorhänge

Les corniches - une solution innovante pour cacher une tringle à rideau

PL

Mardom Decor jako pierwsza firma na rynku zaprojektowała i stworzyła kolekcję listew karniszowych, które stały się ulubionym produktem architektów, projektantów oraz klientów indywidualnych. Posiadamy największy na rynku wybór wzorów, dlatego liczymy, że u nas odnajdą Państwo produkt odpowiedni dla siebie.

ENG

Mardom Decor was the first to introduce curtain system solution in the World, which has become the top choice of architects, designers and private customers. In our offer we have the widest selection of products which will for sure fulfil your needs.

DE

Mardom Decor war das erste Unternehmen der Welt, das eine innovative Gardinen- und Vorhangsystemlösung für Fensterfronten einführt, welche von Architekten, Designern und Privatkunden bevorzugt wird. In unserem Angebot haben wir die größte Auswahl an Produkten, die mit Sicherheit auch Ihre Bedürfnisse erfüllen werden.

FR

Mardom Decor a été la première entreprise sur le marché à concevoir et créer une collection de corniches cache tringles à rideaux, qui sont devenues un des produits préférés des architectes, des designers et des clients particuliers. Nous possédons la plus grande sélection de modèles sur le marché, nous espérons donc que vous trouverez le produit qui vous convient.

NA CZYM POLEGA UNIKATOWOŚĆ LISTEW KARNISZOWYCH?

WHAT'S UNIQUE ABOUT MARDOM DECOR CURTAIN PROFILES? | WAS IST DAS BESONDERE AN DEN GARDINEN- UND VORHANG STUCKPROFILEN VON MARDOM DECOR?
| EN QUOI LES CORNICHES CACHES RIDEAUX SONT ELLES UNIQUES



OSZCZĘDNOŚĆ CZASU I OBNIŻENIE KOSZTÓW REMONTU

Reduction of time and cost during furnishing of interior
Die Reduzierung des zeit- und kostenaufwands bei der Innenausstattung von Innenräumen
Gain de temps et reduction du cout du second oeuvre

PL

Montaż polega na docięciu listwy do określonego wymiaru oraz przyklejeniu jej do sufitu.

ENG

Easy to install by just cutting up to measure and gluing of the profile to the ceiling.

DE

Einfache Montage durch Zuschnitt auf Maß und Verklebung des Profils mit der Decke.

FR

L'installation consiste à couper la moulure à une taille spécifique et à la coller au plafond.



ZASTOSOWANIE PRYWATNE I KOMERCYJNE

Private and commercial use
Private und kommerzielle Nutzung
Utilisation privée et commerciale

PL

Zróznicowaliśmy wielkość listew w taki sposób, aby sprawdzały się we wszystkich typach pomieszczeń - mieszkaniach, kamienicach, loftach, pokojach hotelowych.

ENG

Wide offer of products gives opportunities to use them in various interiors: residential, commercial.

DE

Das breite Angebot an Produkten gibt die Möglichkeit, sie in verschiedenen Innenräumen zu verwenden: z.B. in Wohn- und Geschäftsräumen, Arztpraxen oder Hotelzimmern.

FR

Nous avons diversifié les dimensions des moulures de manière à ce qu'elles s'adaptent à tous types de pièces - appartements, immeubles, lofts, chambres d'hôtel.

NA CZYM POLEGA UNIKATOWOŚĆ LISTEW KARNISZOWYCH?

WHAT'S UNIQUE ABOUT MARDOM DECOR CURTAIN PROFILES? | WAS IST DAS BESONDERE AN DEN GARDINEN- UND VORHANG STUCKPROFILIEN VON MARDOM DECOR?
| EN QUOI LES CORNICHES CACHES RIDEAUX SONT ELLES UNIQUES



INNOWACYJNE ROZWIĄZANIE DLA OŚWIETLENIA LED

Innovative solution for led lighting
Innovative lösung für led-beleuchtung
Solution innovante pour l'éclairage led

PL

Kształt listew pozwala na umieszczenie w specjalnie zaprojektowanej wnęce taśmy LED. Dzięki temu listwa łączy funkcję maskowania karnisza z oświetlaniem pomieszczenia.

ENG

Profiles have been designed to be equipped with LED strips which gives you nice ambient effect.

DE

Die Profile sind so konzipiert, dass sie mit LED-Streifen bestückt werden können, die einen angenehmen Wohlfühl-Effekt erzeugen.

FR

La forme des moulures vous permet de placer une bande LED dans un renforcement spécialement conçu. Grâce à cela, la bande combine la fonction de masquage de la tringle à rideau avec l'éclairage de la pièce.



NAJWYŻSZA JAKOŚĆ

Highest quality
Höchste qualität
La plus haute qualité

PL

Użycie najwyższej jakości surowców przekłada się na gęstość i odporność listew. Listwy produkowane są w fabryce w Łodzi - dlatego czuwamy nad każdym etapem produkcyjnym, eliminując wady i nieprawidłowości.

ENG

Profiles are manufactured with highest quality standard and with use of best possible raw materials in our factory in Poland.

DE

Die Profile werden mit höchstem Qualitätsstandard und unter Verwendung bester Rohstoffe in unserem Werk in Lodz (Polen) hergestellt.

FR

L'utilisation de matières premières de la plus haute qualité se traduit par la densité et la résistance des moulures. Les moulures sont fabriquées dans notre usine de Łódź - c'est pourquoi nous surveillons chaque étape de la production, éliminant les défauts et les irrégularités.

LISTWY KARNISZOWE

CURTAIN PROFILES | GARDINENLEISTEN | CORNICHES CACHE RIDEAUX



QL011

200 x 9,1 x 13 cm

PolyForce® LED

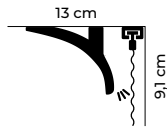

QL026

240 x 10 x 4,1 cm

PolyForce® LED

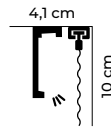

QL066

240 x 10 x 5 cm

ProFoam® LED

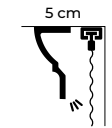

QL116

240 x 12 x 6 cm

ProFoam® LED

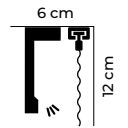

QL076

240 x 12 x 6 cm

ProFoam® LED

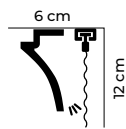

QL046

240 x 12 x 5 cm

PolyForce® LED

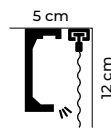

QL086

240 x 13 x 5 cm

ProFoam® LED

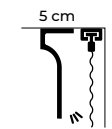

QL036

240 x 14,8 x 4,6 cm

PolyForce® LED

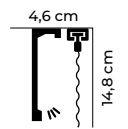



QL056
240 x 18 x 5,5 cm

PolyForce® LED 

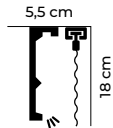

QL016
240 x 18 x 8 cm

ProFoam® LED 

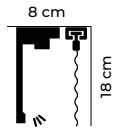

PL

Listwy karniszowe Mardom Decor mogą być stosowane z każdym typem karnisza.

ENG

The products may be used with different types of curtain hanging systems.

DE

Mardom Decor Gardinenblenden können für alle bereits vorhandenen Gardinenschienen verwendet werden.

FR

Les corniches caches tringles à rideaux Mardom Decor peuvent être utilisées avec tout type de tringle à rideaux.



1. MDB135 **2.** QL016 **3.** MDC252 **4.** MDC252-11 **5.** MDD338 **6.** MDD312 **7.** MD020 **8.** D1511

listwy

PRZYPODŁOGOWE

Skirting | Sockelleisten | Plinthes blanches



1.

1. QS011

LISTWY PRZYPODŁOGOWE

niezbędny element każdego wnętrza

Skirting | Sockelleisten | Plinthes blanches

PL

Listwy przypodłogowe to niezbędny element każdego wnętrza. Stanowią estetyczne wykończenie pomiędzy podłogą, a ścianą. Podczas wyboru, warto kierować się zarówno pięknym wyglądem listwy, jak i funkcjonalnością. Nasze listwy przypodłogowe wykonane są z niezwykle trwałego materiału PolyForce, dzięki czemu są odporne na uszkodzenia i działanie wody. Posiadają też specjalne przestrzenie na ukrycie przewodów i kabli. Listwy pokryte są primerem, który ułatwia rozprowadzanie i wchłanianie kolejnych warstw farby. Jeśli poszukujesz listwy gotowej do bezpośredniego montażu, wybierz produkt z kolekcji Mardom Decor Premium - pokryty ekskluzywnym, satynowym lakierem, niewymagającym malowania listwy farbą. Niektóre listwy przypodłogowe posiadają innowacyjną technologię ScratchShield, polegającą na ekstremalnym utwardzeniu listwy. Dzięki temu, listwy przypodłogowe Mardom Decor to najtrwalsze listwy przypodłogowe na rynku.

ENG

Skirting boards are an essential element of any interior. They create an aesthetic finish between the floor and the wall. When choosing a skirting board, it is worth taking into account both its appearance and functionality. Our skirting boards are made of extremely durable PolyForce material ensuring their resistance to damage and water. They also have special spaces for concealing wires and cables. The boards are treated with a primer, which facilitates the application and absorption of subsequent layers of paint. If you are looking for a skirting board for direct installation, choose a product from the Mardom Decor Premium collection - coated with an exclusive satin varnish, which does not require painting the board. Some skirting boards feature the innovative ScratchShield technology, which is based on extreme hardening of the board. As a result, Mardom Decor skirting boards are the most durable skirting boards on the market.

DE

Sockelleisten sind ein essenzieller Bestandteil und nicht mehr wegzudenken aus jedem Innenraum. Sie sind die ästhetische Vollendung zwischen Fußboden und Wand. Bei der Auswahl sollte man sich nicht nur nach dem Design, sondern auch nach der Funktionalität orientieren. Unsere Sockelleisten sind aus dem langlebigen Material PolyForce hergestellt. Dank diesem Material sind unsere Sockelleisten besonders widerstandsfähig gegen Beschädigungen und Feuchtigkeit. Sie besitzen auch zusätzlich einen Hohlraum zur Verdeckung von Leitungen und Kabel. Unsere Leisten sind bereits vorgrundiert, um das Auftragen der Endlackierung zu erleichtern. Sollten Sie eine montagefertige Leiste suchen, bieten wir in der Kollektion Mardom Decor Premium bereits die endlackierten Leisten an. Diese sind mit einem exklusiven und satinierten Lack beschichtet und eignen sich zur sofortigen Montage. Einige unserer Sockelleisten besitzen zusätzlich die innovative ScratchShield Technologie. Diese einzigartige innovative Technologie, die wir exklusiv bei Mardom Decor anbieten besitzen die höchste Kratzunempfindlichkeit am Markt.

FR

Les plinthes sont des éléments indispensables de tout intérieur. Elles offrent une finition esthétique entre le sol et le mur. Lors de votre choix, il convient de considérer à la fois la belle apparence de la plinthe et sa fonctionnalité. Nos plinthes sont fabriquées en matériau PolyForce extrêmement durable, ce qui les rend résistantes au poinçonnement et à l'humidité. Elles ont également des espaces spéciaux pour cacher les fils et les câbles. Les plinthes sont recouvertes d'un apprêt, ce qui facilite la distribution et l'absorption des couches de peinture suivantes. Si vous recherchez une plinthe prête pour une installation directe, choisissez un produit de la collection Mardom Decor Premium - recouvert d'un vernis satiné exclusif, qui ne nécessite pas de peindre la plinthe avec de la peinture. Certaines plinthes sont dotées de la technologie innovante ScratchShield, consistant en un durcissement extrême de la plinthe. Grâce à cela, les plinthes Mardom Decor font parties des plinthes les plus durables du marché.

LISTWY PRZYPODŁOGOWE

SKIRTING | SOCKELLEISTEN | PLINTHES BLANCHES



MD235 (mat) | MD235P (satin)
200 x 1,8 x 1,8 cm

PolyForce® SupremeSatin®

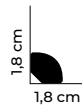

LightGuard®
QL021 (mat) | QL021P (satin)
200 x 2 x 2,5 cm

PolyForce® SupremeSatin®

ScratchShield®



MD001 (mat) | MD001P (satin)
200 x 2,1 x 2,1 cm

PolyForce® SupremeSatin®

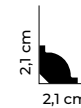

MD011 (mat) | MD011P (satin)
200 x 4 x 1 cm

PolyForce® SupremeSatin®

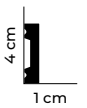

MD004 (mat) | MD004P (satin)
200 x 4,9 x 1,5 cm

PolyForce® SupremeSatin®



MD017 (mat) | MD017P (satin)
200 x 6,9 x 1,4 cm

PolyForce® SupremeSatin®



MD359 (mat) | MD359P (satin)
200 x 7 x 1,6 cm

PolyForce® SupremeSatin® Flex

ScratchShield®



MD234 (mat) | MD234P (satin)
200 x 7,8 x 1,4 cm

PolyForce® SupremeSatin®

Flex ScratchShield®

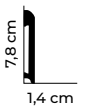



MD024 (mat) | MD024P (satin)
200 x 8 x 2,7 cm

PolyForce® SupremeSatin®
ScratchShield®



MD014 (mat) | MD014P (satin)
200 x 8 x 1,4 cm

PolyForce® SupremeSatin®
ScratchShield®

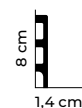

MD008 (mat) | MD008P (satin)
200 x 8 x 1,7 cm

PolyForce® SupremeSatin®
ScratchShield®

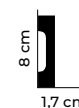

MD018 (mat) | MD018P (satin)
200 x 8 x 1,3 cm

PolyForce® SupremeSatin® Flex
ScratchShield®

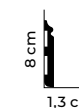

QL019 (mat) | QL019P (satin)
200 x 8 x 2,5 cm

PolyForce® SupremeSatin®
ScratchShield®

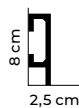

MD258 (mat) | MD258P (satin)
200 x 8,1 x 1 cm

PolyForce® SupremeSatin®

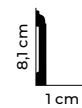

MD8300 (mat) | MD8300P (satin)
200 x 8,2 x 1,7 cm

PolyForce® SupremeSatin®

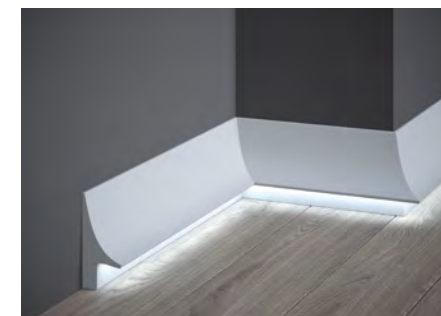

QL007 (mat) | QL007P (satin)
200 x 9,3 x 4,2 cm

PolyForce® SupremeSatin® LED

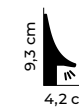

Dostępny klips montażowy
Assembly clip available
Erhältlicher Befestigungsclip
Clip de montage disponible

LISTWY PRZYPODŁOGOWE

SKIRTING | SOCKELLEISTEN | PLINTHES BLANCHES



MD094 (mat) | MD094P (satin)
200 x 9,4 x 1,2 cm

PolyForce® SupremeSatin®

ScratchShield®

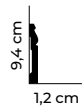

MD355 (mat) | MD355P (satin)
200 x 9,7 x 2 cm

PolyForce® SupremeSatin® Flex

ScratchShield®

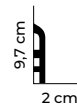

MD236 (mat) | MD236P (satin)
200 x 9,9 x 1,3 cm

PolyForce® SupremeSatin®

ScratchShield®

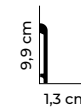

LightGuard®
QL019 + QL021 (mat)
| QL019P + QL021P (satin)
200 x 8 x 2,5 cm + 200 x 2 x 2,5 cm

PolyForce® SupremeSatin®

ScratchShield®

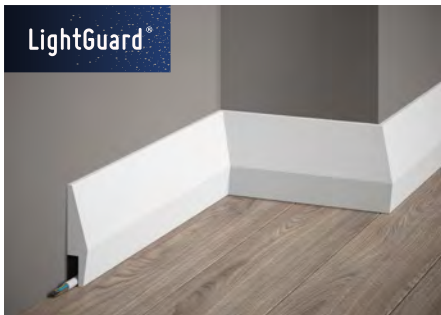
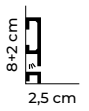

MD016 (mat) | MD016P (satin)
200 x 10 x 2,3 cm

PolyForce® SupremeSatin®

ScratchShield®



QS009 (mat) | QS009P (satin)
200 x 10 x 1,6 cm

PolyForce® SupremeSatin®

ScratchShield®

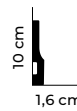

MD009 (mat) | MD009P (satin)
200 x 10 x 1,7 cm

PolyForce® SupremeSatin®

ScratchShield®



MD013 (mat) | MD013P (satin)
200 x 10 x 1 cm

PolyForce® SupremeSatin®

ScratchShield®

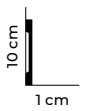



MD006 (mat) | MD006P (satin)
200 x 10,1 x 2,3 cm

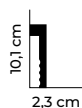
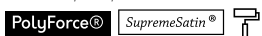

Wymiary wnęki: 9 x 1,5 cm
Niche dimensions: 9 x 1,5 cm
Einbautiefe: 9 x 1,5 cm
Les dimensions du renforcement: 9 x 1,5 cm



MD363 (mat) | MD363P (satin)
200 x 10,6 x 2,3 cm

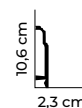

Wymiary wnęki: 9 x 1,5 cm
Niche dimensions: 9 x 1,5 cm
Einbautiefe: 9 x 1,5 cm
Les dimensions du renforcement: 9 x 1,5 cm



MD354 (mat) | MD354P (satin)
200 x 10,7 x 1,1 cm

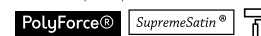

Wymiary wnęki: 9 x 1,5 cm
Niche dimensions: 9 x 1,5 cm
Einbautiefe: 9 x 1,5 cm
Les dimensions du renforcement: 9 x 1,5 cm



QS004 (mat) | QS004P (satin)
200 x 10,8 x 1,5 cm



Wymiary wnęki: 9 x 1,5 cm
Niche dimensions: 9 x 1,5 cm
Einbautiefe: 9 x 1,5 cm
Les dimensions du renforcement: 9 x 1,5 cm



MD025 (mat) | MD025P (satin)
200 x 11 x 2,7 cm



Wymiary wnęki: 8,7 x 1,3 cm
Niche dimensions: 8,7 x 1,3 cm
Einbautiefe: 8,7 x 1,3 cm
Les dimensions du renforcement: 8,7 x 1,3 cm



MD005 (mat) | MD005P (satin)
200 x 11 x 2,2 cm



Wymiary wnęki: 8,7 x 1,3 cm
Niche dimensions: 8,7 x 1,3 cm
Einbautiefe: 8,7 x 1,3 cm
Les dimensions du renforcement: 8,7 x 1,3 cm



MD356 (mat) | MD356P (satin)
200 x 11 x 1,5 cm

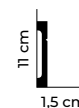

ScratchShield®

Wymiary wnęki: 8,7 x 1,3 cm
Niche dimensions: 8,7 x 1,3 cm
Einbautiefe: 8,7 x 1,3 cm
Les dimensions du renforcement: 8,7 x 1,3 cm



MD358 (mat) | MD358P (satin)
200 x 11,7 x 1,4 cm



ScratchShield®

Wymiary wnęki: 8,7 x 1,3 cm
Niche dimensions: 8,7 x 1,3 cm
Einbautiefe: 8,7 x 1,3 cm
Les dimensions du renforcement: 8,7 x 1,3 cm

LISTWY PRZYPODŁOGOWE

SKIRTING | SOCKELLEISTEN | PLINTHES BLANCHES



MD095 (mat) | MD095P (satin)
200 x 12 x 1,5 cm

PolyForce® SupremeSatin®

ScratchShield®



QS003 (mat) | QS003P (satin)
200 x 12,8 x 1,8 cm

PolyForce® SupremeSatin®



QS011 (mat) | QS011P (satin)
200 x 13,5 x 4 cm

PolyForce® SupremeSatin®

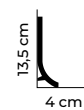

MD360 (mat) | MD360P (satin)
200 x 13,7 x 1,8 cm

PolyForce® SupremeSatin® Flex

ScratchShield®



MD361 (mat) | MD361P (satin)
200 x 14,4 x 1,5 cm

PolyForce® SupremeSatin®

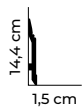

MD020 (mat) | MD020P (satin)
200 x 19,8 x 1,9 cm

PolyForce® SupremeSatin®

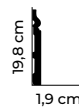



1. MDB137 2. MD325 3. MD002 4. MD003 5. MD360

listwy

ŚCIENNE

Wall mouldings | Wandprofile | Les moulures murales



1. MD003 2. MD325 3. MDD346 4. MDB117 5. MDB180 6. MD356

LISTWY ŚCIENNE

różnorodne dekoracje

Wall mouldings | Wandprofile | Les moulures murales

PL

Listwy ścienne służą do tworzenia różnorodnych dekoracji ściennych. Małe listwy najlepiej sprawdzą się w formie ramek i paneli ściennych. Większe profile będą odpowiednie do stworzenia odcień na ścianie. Listwy ścienne wykonane są z dwóch typów materiału: PolyForce oraz ProFoam. Listwy wykonane z PolyForce cechują się najwyższą odpornością na uszkodzenia. Tworzywo ProFoam daje możliwość tworzenia wyraźnych i głębokich zdobień. Wszystkie listwy są wodoodporne, dzięki czemu mogą być stosowane w łazienkach i kuchniach. W katalogu znajdziesz wiele inspiracji do wykorzystania listew ściennych w swoim domu.

ENG

Wall mouldings are used to create various wall decorations. Small mouldings will work best in the form of wall frames and panels. Larger mouldings will be suitable for separating sections of the wall. Wall mouldings are made of two types of material: PolyForce and ProFoam. Mouldings made of PolyForce are characterised by the highest resistance to damage. ProFoam offers the opportunity to create clear and deep-cut decorations. All mouldings are waterproof, making them suitable for use in bathrooms and kitchens. Our catalogue contains numerous inspiring ideas for using wall mouldings in your home.

DE

Unsere Wandleisten dienen zur vielfältigen Gestaltung verschiedenster Wanddekorationen. Kleine Leisten eignen sich vor allem zur Anfertigung von Rahmen und Wandpaneelen. Größere Profile eignen sich zur Höhenabtrennung an einer hohen Wand. Mardom Decor Wandleisten bestehen aus zwei Materialtypen: PolyForce und ProFoam. Leisten, die aus PolyForce angefertigt sind, zeichnen sich durch besondere Unempfindlichkeit gegen Stöße/Beschädigungen aus. ProFoam hingegen ermöglicht, klare und tiefe Verzierungen zu schaffen. Alle Leisten sind wasserabweisend und können somit auch in Bädern und Küchen verwendet werden. Im Katalog finden Sie einige Inspirationen zur Verwendung von Mardom Decor Wandleisten für Ihr Zuhause.

FR

Les moulures murales sont utilisées pour créer une variété de décorations murales. Les petites moulures s'adaptent mieux pour une forme de cadres et de panneaux muraux. Des profils plus grands conviendront à la création de découpes murales. Les moulures murales sont constituées de deux types de matériaux: PolyForce et ProFoam. Les plinthes en PolyForce se caractérisent par la plus haute résistance au poinçonnement. Le matériau ProFoam vous permet de créer des décorations claires et profondes. Toutes les moulures sont étanches, elles peuvent donc être utilisées dans les salles de bain et les cuisines. Dans le catalogue, vous trouverez beaucoup d'inspiration pour l'utilisation de moulures murales dans votre maison.

LISTWY ŚCIENNE GŁADKIE

PLAIN WALL MOULDINGS | FLACHE WANDLEISTEN | MOULURES LISSES

**MDD316**

240 x 1,5 x 0,5 cm

ProFoam® **MD010**

200 x 1,5 x 1,5 cm

PolyForce® **MD012**

200 x 2 x 0,5 cm

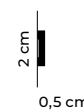
PolyForce® **NEW**
QL022

200 x 2 x 1 cm

PolyForce®  ScratchShield® **MDD312**

240 x 2,2 x 0,9 cm

ProFoam®  Flex **MD003**

200 x 2,2 x 1 cm

PolyForce®  ScratchShield® **MDD413**

240 x 2,5 x 1,2 cm

ProFoam® **NEW**
MD413

200 x 2,5 x 1,2 cm

PolyForce® 



MDD318
240 x 3,3 x 1,5 cm
ProFoam®



MD255
200 x 3,9 x 2 cm
PolyForce® ScratchShield®

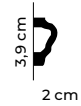

MD002
200 x 4 x 1,8 cm
PolyForce® ScratchShield®

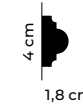

NEW
QL023
200 x 4 x 1,9 cm
PolyForce®



MDD332
240 x 4,1 x 1,7 cm
ProFoam® Flex



MDD325
240 x 4,1 x 1,5 cm
ProFoam® Flex



NEW
MD325
200 x 4,1 x 1,5 cm
PolyForce® ScratchShield®



NEW
MD026
200 x 4,5 x 1,5 cm
PolyForce®



LISTWY ŚCIENNE GŁADKIE

PLAIN WALL MOULDINGS | FLACHE WANDLEISTEN | MOULURES LISSES



MD317
200 x 4,5 x 1,5 cm

PolyForce® 



MDD414
240 x 5,1 x 1,1 cm

ProFoam® Flex 



MDD314
240 x 5,2 x 1,7 cm

ProFoam® Flex 



MDD346
240 x 6,1 x 2,5 cm

ProFoam® Flex 

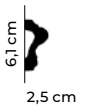

MDD308
240 x 6,5 x 2,1 cm

ProFoam® 



QL006
200 x 7 x 4,2 cm

PolyForce® LED 



MD007
200 x 7,3 x 2,3 cm

PolyForce® ScratchShield® 



MDD412
240 x 7,5 x 1,8 cm

ProFoam® 

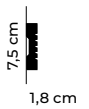



MDD351
240 x 7,6 x 2,5 cm
ProFoam® Flex



MD024
200 x 8 x 2,7 cm
PolyForce® LED ScratchShield



QL019
200 x 8 x 2,5 cm
PolyForce® LED ScratchShield



MDD338
240 x 8 x 2,1 cm
ProFoam® Flex

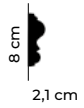

MDD339
240 x 8,1 x 1,9 cm
ProFoam® Flex



MDD311
240 x 8,5 x 2,5 cm
ProFoam® Flex



MDD305
240 x 9 x 2,8 cm
ProFoam®



D1541
240 x 9,7 x 2,2 cm
ProFoam®



LISTWY ŚCIENNE GŁADKIE

PLAIN WALL MOULDINGS | FLACHE WANDLEISTEN | MOULURES LISSES



QL017

200 x 10 x 2,5 cm

PolyForce® LED



2,5 cm



MD016

200 x 10 x 2,3 cm

PolyForce® LED

ScratchShield



2,3 cm



MDD334

240 x 10,1 x 3,3 cm

ProFoam®



3,3 cm



MDD345

240 x 10,2 x 2,4 cm

ProFoam® Flex



2,4 cm



MDD410

240 x 10,8 x 2 cm

ProFoam®



2 cm



MD025

200 x 11 x 2,7 cm

PolyForce® LED



2,7 cm



QS011

200 x 13,5 x 4 cm

PolyForce® LED



4 cm



MDD335

240 x 15,5 x 5,4 cm

ProFoam®



5,4 cm



MDD315
240 x 22 x 6,4 cm
ProFoam® 

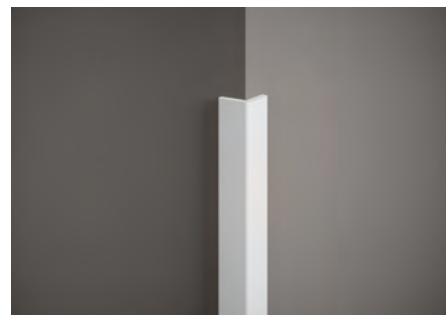

MD237
200 x 3 x 3 cm
PolyForce® 



MDB123
240 x 4,1 x 4,1 cm
ProFoam® 



LISTWY ŚCIENNE ORNAMENTACYJNE

ORNAMENTED WALL MOULDINGS | WANDLEISTEN MIT ORNAMENTEN VERZIERT | MOULURES AVEC ONEMENTATION



MDC255
240 x 5 x 1,6 cm
ProFoam®

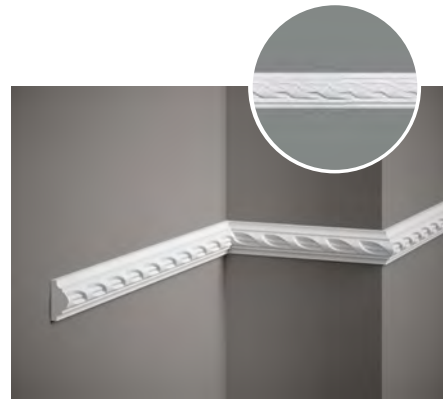
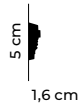

MDC252
240 x 5,4 x 2,3 cm
ProFoam® Flex



MDC258
240 x 5,4 x 2 cm
ProFoam® Flex

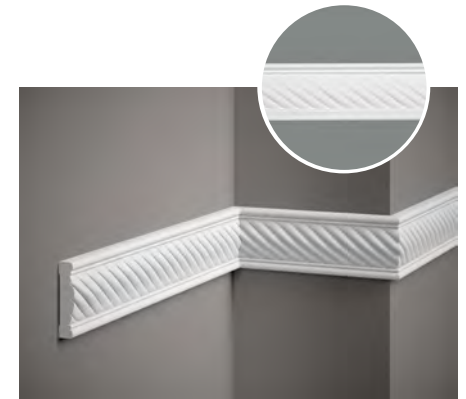
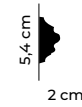

MDC239
240 x 7,5 x 1,5 cm
ProFoam® Flex



MDC217
240 x 7,8 x 1,3 cm
ProFoam® Flex



MDC250
240 x 8,1 x 2 cm
ProFoam® Flex



MDC236
240 x 12,8 x 1,4 cm
ProFoam® Flex





1. MDC236

2. MDC258

3. MDC217

4. MDA007

5. MDC239

6. MDC252

7. MDB161

listwy

S U F I T O W E

Cornice mouldings | Deckenleisten | Les moulures de plafond



1. MDB158 2. MD255 3. MD009

LISTWY SUFITOWE

całkowita odmiana wnętrza

Cornice mouldings | Deckenleisten | Les moulures de plafond

PL

—

Listwy sufitowe to element dekoracyjny, który może całkowicie odmienić Twoje wnętrze. Listwy wykonane są z lekkiego, ale bardzo trwałego tworzywa, które umożliwia montaż na wysokościach. W zależności od wielkości i stylu Twojego wnętrza, możesz wybierać spośród listew małych i dużych, oraz tych gładkich i ornamentacyjnych. Listwy pokryte są białą farbą podkładową, która stanowi wygładzającą bazę pod kolejne warstwy farby. Wnętrze ozdobione listwami sufitowymi daje efekt pomysłowości i dbałości o detale.

ENG

—

Cornice mouldings are a decorative feature that can completely change your interior. The mouldings are made of lightweight but very durable material, which makes it possible to install them at heights. Depending on the size and style of your interior, you can choose from small and large mouldings, as well as plain and ornamental ones. The mouldings are covered with a white primer, which is a smoothing base coat for subsequent layers of paint. The interior decorated with cornice mouldings gives the effect of creativity and attention to detail.

DE

—

Deckenleisten sind Dekorationselemente, welche den Innenraum komplett verändern können. Diese Leisten sind aus einem leichten, aber sehr langlebigen Material hergestellt, welches die Anbringung an der Decke erleichtert. Im Zusammenhang von Größe und Stil Ihres Innenraumes, können Sie aus einer Vielzahl von kleinen und großen, sowie glatten und mit Ornamenten versehenen Leisten wählen. Unsere Leisten sind weiß vorgrundiert, für den perfekten Endanstrich. Innenräume, welche mit Deckenleisten versehen sind, vermitteln den Eindruck von Kreativität und der Liebe zum Detail.

FR

—

Les moulures de plafond sont un élément décoratif qui peut complètement changer votre intérieur. Les moulures sont fabriquées dans un matériau léger mais très résistant qui permet une installation en hauteur. Selon la surface et le style de votre intérieur, vous pouvez choisir entre des petites et de grandes moulures, ainsi que des modèles lisses et ornementaux. Les moulures sont recouvertes d'une peinture d'apprêt blanche, qui sert de base de lissage pour les couches de peinture suivantes. Un intérieur décoré de moulures de plafond apporte une touche d'originalité et d'attention aux détails.

LISTWY SUFITOWE GŁADKIE

PLAIN CORNICE MOULDINGS | FLACHE DECKENLEISTEN | CORNICHES LISSES



MDB180
240 x 2,5 x 1,5 cm
ProFoam® 

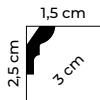

MDB135
240 x 2,8 x 3,2 cm
ProFoam®  Flex 

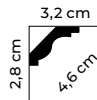

MDB136
240 x 4 x 4 cm
ProFoam®  Flex 

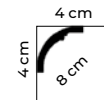

MDB172
240 x 4 x 4 cm
ProFoam®  Flex 

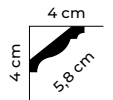

MDB112
240 x 4,4 x 4,4 cm
ProFoam®  Flex 



MDB130
240 x 5 x 19 cm
ProFoam® 

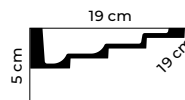

MDB063
240 x 5 x 5 cm
ProFoam® 

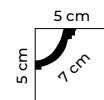

MDB210
240 x 5,1 x 4,8 cm
ProFoam®  Flex 

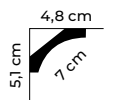



MDB174
240 x 4,9 x 5,2 cm
ProFoam®

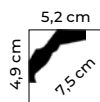

MD368
200 x 5,1 x 5,1 cm
PolyForce®

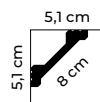

MDB167
240 x 5,5 x 5,5 cm
ProFoam®

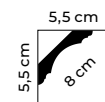

MDB132
240 x 5,5 x 8,7 cm
ProFoam®



MDB147
240 x 5 x 5,5 cm
ProFoam®

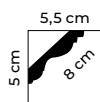

MDB127
240 x 6 x 13 cm
ProFoam®

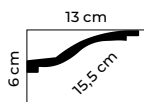

MDB106
240 x 5,7 x 5,7 cm
ProFoam® Flex



MDB145
240 x 6 x 6 cm
ProFoam® Flex

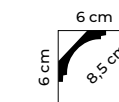

LISTWY SUFITOWE GŁADKIE

PLAIN CORNICE MOULDINGS | FLACHE DECKENLEISTEN | CORNICHES LISSES

**MDB001**

240 x 6,7 x 6,7 cm

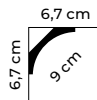
ProFoam® **MDB064**

240 x 6,4 x 6,8 cm

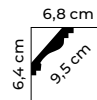
ProFoam® **MDB185**

240 x 6,2 x 6 cm

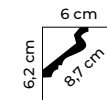
ProFoam®  Flex **MD367**

200 x 7,2 x 7,2 cm

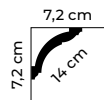
PolyForce® **MDB152**

240 x 7,6 x 7,6 cm

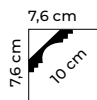
ProFoam®  Flex **MDB134**

240 x 8 x 8 cm

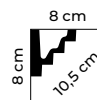
ProFoam® **MDB102**

240 x 8 x 8,2 cm

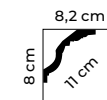
ProFoam®  Flex **MDB213**

240 x 8,6 x 8 cm

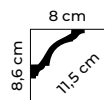
ProFoam®  Flex 



MDB117
240 x 8,5 x 9 cm

ProFoam® Flex

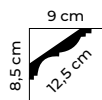

MDB131
240 x 9 x 14 cm

ProFoam®

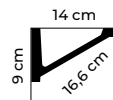

MDB161
240 x 9 x 8,5 cm

ProFoam®

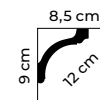

MDB111
240 x 8,8 x 6 cm

ProFoam®

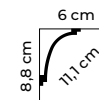

MDB110
240 x 9 x 11 cm

ProFoam® Flex

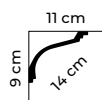

MDB137
240 x 9,6 x 5,5 cm

ProFoam®

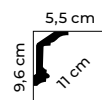

MDB142
240 x 9,6 x 8 cm

ProFoam®

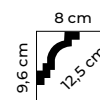

MDB118
240 x 10 x 9,7 cm

ProFoam® Flex

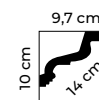

LISTWY SUFITOWE GŁADKIE

PLAIN CORNICE MOULDINGS | FLACHE DECKENLEISTEN | CORNICHES LISSES

**MDB108**

240 x 10 x 10 cm

ProFoam® Flex

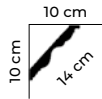
**MDB158**

240 x 10,5 x 12,2 cm

ProFoam®

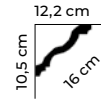
**MDB105**

240 x 10,8 x 12,2 cm

ProFoam®

**MDB156**

240 x 11,2 x 14,4 cm

ProFoam®

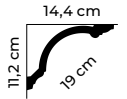
**MDB121**

240 x 11,6 x 22,4 cm

ProFoam®

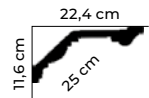
**MDB169**

240 x 12 x 12,9 cm

ProFoam® Flex

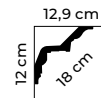
**MDB214**

240 x 14,5 x 14,6 cm

ProFoam®

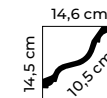
**MDB154**

240 x 14,8 x 12,4 cm

ProFoam®

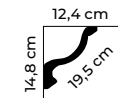



MDB140
 240 x 15,8 x 15,3 cm
 ProFoam® 

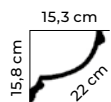

MDB104
 240 x 17 x 11,8 cm
 ProFoam® 

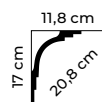

MDB128
 240 x 17,8 x 17 cm
 ProFoam® 

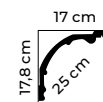

MDB103
 240 x 18 x 14 cm
 ProFoam® 

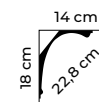

Pasuje do MDA113 i MDA109
 Suitable for the MDA113 and MDA109
 Kompatibel mit MDA113 und MDA109
 Comptable avec les références MDA113 et MDA109



MDB155
 240 x 21,6 x 21,6 cm
 ProFoam® 

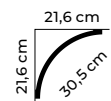



1.

2.

3.

1. MDB110

2. MD002

3. MD234

LISTWY SUFITOWE ORNAMENTACYJNE

ORNAMENTED CORNICE MOULDINGS | WANDELEISTEN MIT ORNAMENTEN VERZIERT | CORNICHES AVEC ORNEMENTATION



MDA005

240 x 5,8 x 5,8 cm

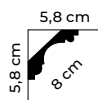

MDA008

240 x 7 x 8,2 cm

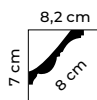

MDA121

240 x 7,4 x 7 cm

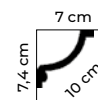

MDA106

240 x 7,5 x 7,5 cm

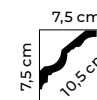

MDA212

240 x 7,8 x 4,4 cm



MDA002

240 x 8,2 x 8,6 cm



MDA007

240 x 10 x 9,2 cm



MDA040

240 x 13,5 x 11 cm





LISTWY SUFITOWE ORNAMENTACYJNE

ORNAMENTED CORNICE MOULDINGS | WANDLEISTEN MIT ORNAMENTEN VERZIERT | CORNICHES AVEC ORNEMENTATION

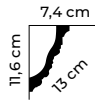

MDA098
240 x 11,6 x 7,4 cm
ProFoam® 



MDA046
240 x 11,2 x 11,4 cm
ProFoam®  Flex 

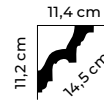

MDA067
240 x 13,3 x 13,7 cm
ProFoam® 

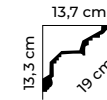

MDA138
240 x 13,8 x 15,2 cm
ProFoam® 

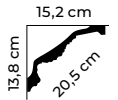

MDA072
240 x 14,8 x 6,4 cm
ProFoam® 

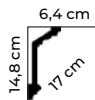

MDA218
240 x 15 x 11,8 cm
ProFoam® 

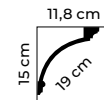

MDA401
240 x 14,1 x 16,9 cm
ProFoam® 

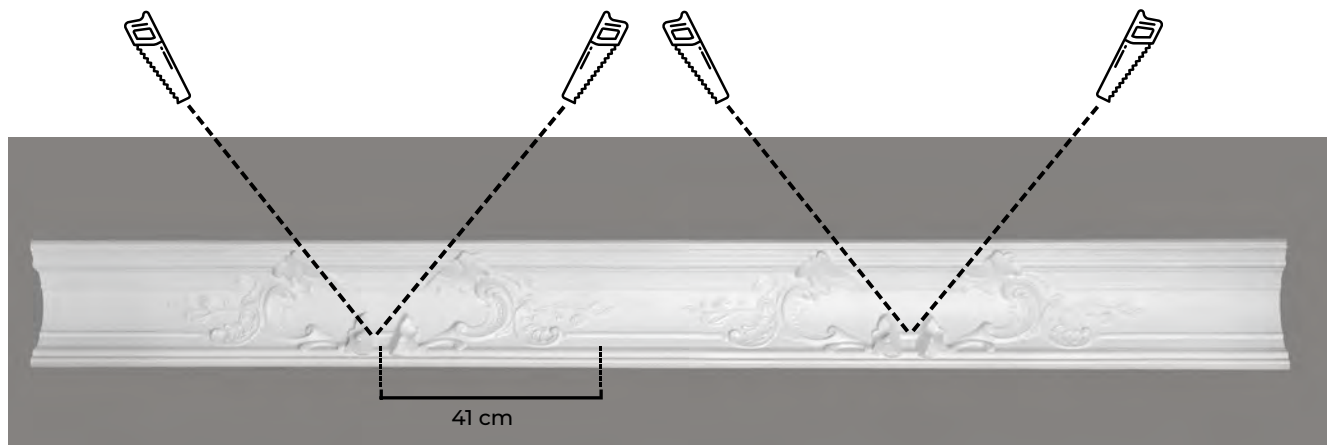

**MDA113**

240 x 17,8 x 17 cm

ProFoam® 

Z jednej listwy można wykonać 2 narożniki | You can make 2 corners from one moulding
 | Aus einer Leiste können zwei Ecken gemacht werden | Deux angles peuvent être conçus à partir d'une moulures



Pasuje do MDB128 i MDA109 | Suitable for the MDB128 and MDA109 | Kompatibel mit MDB128 und MDA109 | Comptable avec les références MDB128 et MDA109

**MDA109**

240 x 17,8 x 17 cm

ProFoam® 

Pasuje do MDB128 i MDA113 | Suitable for the MDB128 and MDA113 | Kompatibel mit MDB128 und MDA113 | Comptable avec les références MDB128 et MDA113



listwy

OŚWIETLENIOWE

Lighting mouldings | Lichtleisten
| Corniches d'éclairage



1. MDB150 2. QR002 3. MD025 4. QL023 5. QL019 6. QL021

LISTWY OŚWIETLENIOWE

innovacyjne rozwiązania oświetleniowe

Lighting mouldings | Lichtleisten | Corniches d'éclairage

PL

Listwy oświetleniowe to najpopularniejszy element nowoczesnych wnętrz. W ciągu dnia spełniają swoją standardową funkcję, dekorując i maskując łączenia między płaszczyznami. Wieczorem są natomiast źródłem subtelnego światła, dodającego pomieszczeniu przytulnego charakteru. Listwy posiadają specjalnie wyprofilowane przestrzenie na ukrycie taśmy LED. Niektóre listwy posiadają innowacyjną technologię LightGuard, zapobiegającą przebijaniu światła przez powierzchnię listwy. Dzięki temu, oświetlenie jest pięknie rozproszone. Listwy bez technologii LightGuard wystarczy okleić od wewnętrznej strony taśmą aluminiową, aby uzyskać równie nieskazitelny efekt podświetlenia.

ENG

Lighting mouldings are the most popular element of modern interiors. During the day, they perform their standard function by decorating and masking the joints between planes, whereas in the evening they are a source of subtle light that gives the room a cosy feel. The mouldings have specially profiled spaces to hide the LED strip. Some mouldings have an innovative LightGuard technology, which prevents the light from penetrating the moulding surface. Thanks to this, the light is beautifully dispersed. Mouldings without the LightGuard technology only need to be taped from the inside with aluminium tape to achieve an equally flawless lighting effect.

DE

LED taugliche Leisten sind die beliebtesten Elemente der modernen Inneneinrichtung. Am Tag erfüllen Sie ihre Standardfunktion, dekorieren und vollenden die Verbindung zwischen Wand und Decke. Am Abend sind sie eine dezente Lichtquelle, welche dem Raum eine gemütliche Charaktereigenschaft verleiht. Die LED-Leisten haben spezielle Innenprofile zur Verdeckung der LED-Stripes. Einige unserer Leisten besitzen zudem auch die neuste LightGuard Technologie, die das Durchschimmern der Lichtquelle durch die Leiste verhindert. Auf diese Weise wird die Beleuchtung gleichmäßig verteilt. Leisten ohne LightGuard Technologie können mit einem Aluminiumband von innen beklebt werden, um den Effekt zu erzielen.

FR

Les corniches d'éclairage sont devenues les éléments de finition les plus populaires des intérieurs modernes. La journée, elles remplissent leur fonction standard, décorer et masquer les angles. Le soir, elles deviennent une source de lumière subtile, ajoutant un caractère cosy à la pièce. Les bandes ont des espaces spécialement profilés pour cacher la bande LED. Certaines bandes disposent de la technologie innovante LightGuard qui empêche la lumière de pénétrer la surface de la corniche. En conséquence, l'éclairage est magnifiquement diffusé. Les bandes sans technologies LightGuard doivent simplement être recouvertes de ruban d'aluminium côté l'intérieur pour obtenir un effet d'éclairage tout aussi impeccable.

LISTWY OŚWIETLENIOWE

LIGHTING MOULDINGS | LICHTLEISTEN | CORNICHES D'ÉCLAIRAGE



QL007
200 x 9,5 x 4,2 cm

PolyForce® SupremeSatin® LED

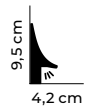

QL019 + QL021
200 x 8 x 2,5 cm + 200 x 2 x 2,5 cm

PolyForce® SupremeSatin® LED

ScratchShield®



QL006
200 x 7 x 4,2 cm

PolyForce® LED



QL017
200 x 10 x 2,5 cm

PolyForce® LED

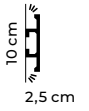

MD368
200 x 5,1 x 5,1 cm

PolyForce® LED

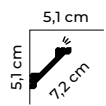

MD118
200 x 7 x 2,7 cm

PolyForce® LED

ScratchShield®

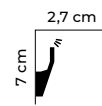

MDB070
240 x 7,2 x 4 cm

ProFoam® LED

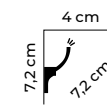

MD367
200 x 7,2 x 7,2 cm

PolyForce® LED

ScratchShield®



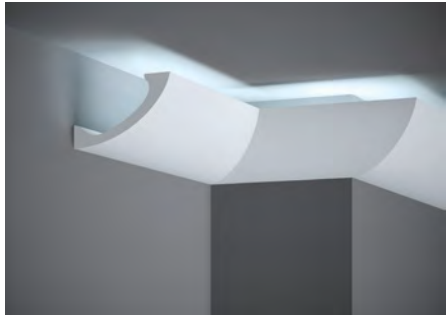

MD369
200 x 7,8 x 11,5 cm
PolyForce® LED

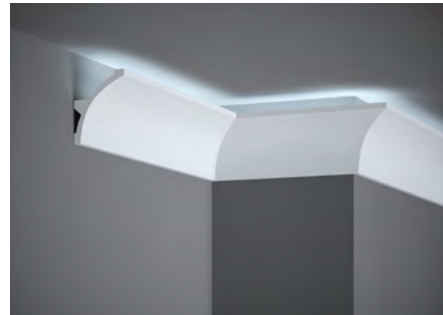
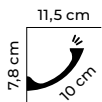

MDB080
240 x 8 x 6 cm
ProFoam® LED

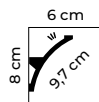

MD024
200 x 8 x 2,7 cm
PolyForce® LED
ScratchShield™

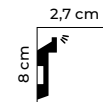

QL019
200 x 8 x 2,5 cm
PolyForce® LED
ScratchShield™

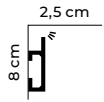

QL002
200 x 8,5 x 8,5 cm
PolyForce® LED

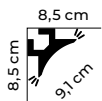

MD362
200 x 8,6 x 17,2 cm
PolyForce® LED

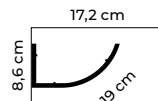

MD016
200 x 10 x 2,3 cm
PolyForce® LED
ScratchShield™

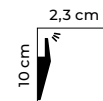

MDB100
240 x 10 x 5 cm
ProFoam® LED

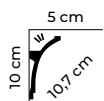

LISTWY OŚWIETLENIOWE

LIGHTING MOULDINGS | LICHTLEISTEN | CORNICHES D'ÉCLAIRAGE



MD105
240 x 10,8 x 12,2 cm

PolyForce® LED 

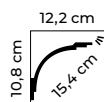

MD025
200 x 11 x 2,7 cm

PolyForce® LED 

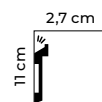

MDB115
240 x 11 x 6 cm

ProFoam® LED 

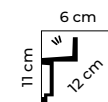

QL009
200 x 12 x 4,7 cm

PolyForce® LED 

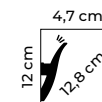

QL010
200 x 12 x 4,2 cm

PolyForce® LED 

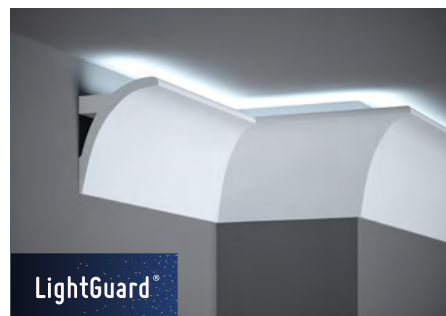
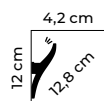

QL011
200 x 13 x 9,1 cm

PolyForce® LED 

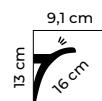

QS011
200 x 13,5 x 4 cm

PolyForce® LED 

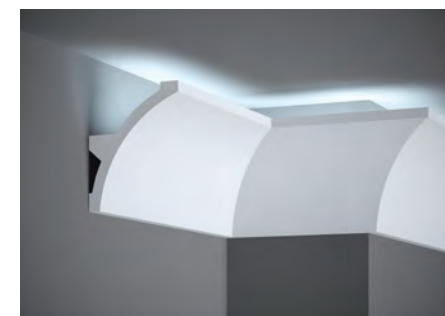
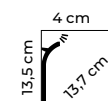

MDB101
240 x 14 x 10,6 cm

ProFoam® LED 

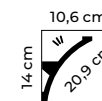



QL001
200 x 14,7 x 14,7 cm

PolyForce® LED 

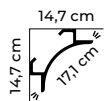

MDB150
240 x 15 x 4 cm

ProFoam® LED 

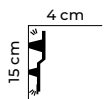

1. MDD345

2. MDD314

3. MD009

4. MD094

DEKORACJE

Decorative elements | Zierelemente | Éléments décoratifs



1. MDA072

DEKORACJE

oryginalne uzupełnienie aranżacji

Decorative elements | Zierelemente | Éléments décoratifs

PL

Dzięki elementom dekoracyjnym Mardom Decor uzupełnisz aranżację swojego wnętrza. Wsporniki, dekory i obramowania wykonane są z wodoodpornego i trwałego materiału ProFoam, którego gęstość pozwala na stworzenie głębokich i wyraźnych zdobień. Wszystkie elementy pokryte są białym primerem, który ułatwia wchłanianie kolejnych warstw farby.

ENG

With Mardom Decor decorative elements you will complement the design of your interior. Brackets, decors and surrounds are made of waterproof and durable ProFoam material, whose density allows to create deep-cut and distinct decorations. All elements are treated with a white primer, which facilitates the absorption of subsequent layers of paint.

DE

Dank der dekorativen Elemente von Mardom Decor vervollständigen Sie Ihre Innenraumgestaltung. Alle dekorativen Elemente sind aus einem Wasserabweisendem und langanhaltendem Material, ProFoam, hergestellt, welches exakte und detaillierte Formen ermöglicht. Alle Elemente sind vorgestrichen und erleichtern so die weitere Beschichtung.

FR

Grâce aux éléments décoratifs Mardom Decor, vous complétez votre aménagement intérieur. Les supports, décors et ornements sont en matériau ProFoam étanche et durable, dont la densité permet la création de décorations profondes et claires. Tous les éléments sont recouverts d'un apprêt blanc, ce qui facilite l'absorption des couches de peinture suivantes.

NAROŽNIKI

CORNERS | ECKEN MIT WANDLEISTEN | ÉLÉMENTS D'ANGLES DE MOULURES



MDD332-13 + MDD332

15,5 x 15,5 x 1,7 cm

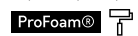

MDD318-12 + MDD318

17 x 17 x 1,5 cm



MDD325-12 + MDD325

23 x 23 x 1,5 cm



MDD308-12 + MDD308

24 x 24 x 2,1 cm



MDC258-12 + MDC258

25,5 x 25,5 x 1,9 cm



MDC250-12 + MDC250

41 x 41 x 2 cm



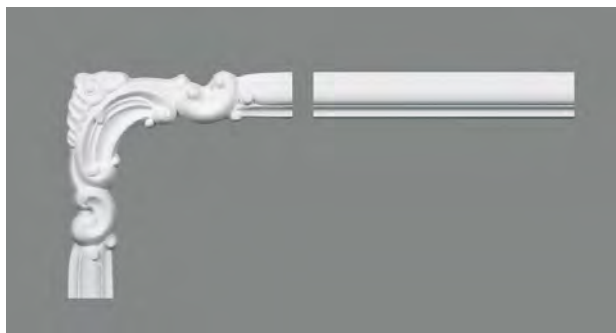

MDD332-11 + MDD332

21 x 21 x 1,7 cm



MDC252-11 + MDC252

24 x 24 x 1,9 cm



MDC258-13 + MDC258

25,5 x 25,5 x 1,9 cm



MDD308-11 + MDD308

27 x 27 x 2,1 cm



MDC250-11 + MDC250

50,5 x 50,5 x 2 cm



MDD332-12 + MDD332

23,5 x 11 x 1,7 cm



ROZETY

CEILING ROSES | ROSETTEN | ROSACES

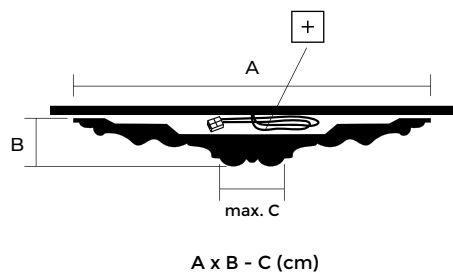

B3110
 Ø 9,4 x 1,8 cm
 ProFoam®

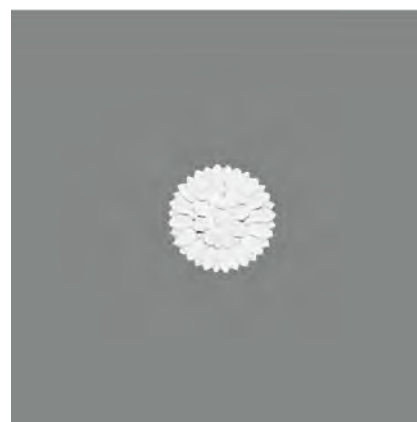

B3002
 Ø 15,5 x 3 cm
 ProFoam®

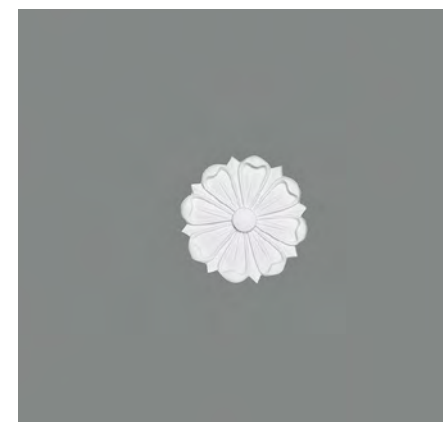

B3021
 Ø 16 x 1,6 cm
 ProFoam®



B3014
 Ø 32 x 4 cm
 ProFoam®



B3030
 Ø 37,5 x 4,6 - 10 cm
 ProFoam®



B3029
 Ø 38 x 4,5 - 7,5 cm
 ProFoam® +



B3033
 Ø 49,2 x 5,4 - 14 cm
 ProFoam® +



QR001
 ø 51,8 x 4 – 15,5 cm
 ProFoam®



B3020
 ø 51,4 x 3,5 – 10 cm
 ProFoam® +



B3025
 ø 52,6 x 4 – 10 cm
 ProFoam®



QR002
 ø 51,5 x 5 cm
 ProFoam® +



QR005
 ø 60 x 60 x 5 cm
 ProFoam® +



B3047
 ø 59,6 x 7 – 15 cm
 ProFoam® +



B3023
 ø 59,2 x 8,5 – 8,5 cm
 ProFoam® +



B3038
 ø 61,5 x 4 – 14 cm
 ProFoam® +

ROZETY

CEILING ROSES | ROSETTEN | ROSACES



B3050
 ø 67 x 5,3 – 6,5 cm
 ProFoam®



B2021
 74,8 x 51 x 4 cm
 ProFoam®



B3077
 ø 75,2 x 4 – 8 cm
 ProFoam®



B3015
 ø 82,8 x 6,4 – 15 cm
 ProFoam®

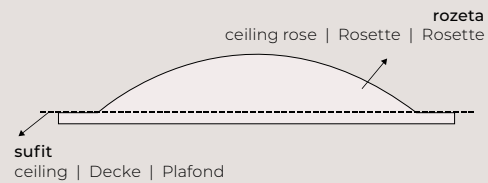

PL Rozety o przekroju wklęsłym
 - wpuszczane w sufit

EN Rosettes with concave section
 - recessed into the ceiling

DE Nach innen gewölbte Kuppel zum einlassen
 in die Decke

FR Rosaces concaves - encastrées dans le plafond



B2002
 ø 72 x 12,5 cm
 ProFoam®



B2003
 ø 113 x 21,5 cm
 ProFoam®



B2004
 ø 123 x 15 cm
 ProFoam® +

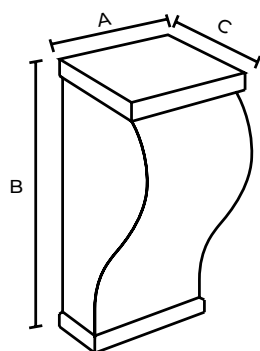

A x B x C (cm)



C1000-1W
26,5 x 10,5 x 26,5 cm
ProFoam®



C1001-1W
30 x 11,5 x 30 cm
ProFoam®



C1002-1W
36 x 12,5 x 36 cm
ProFoam®



C1000-2W
29 x 20,7 x 29 cm
ProFoam®



C1001-2W
33 x 24,5 x 33 cm
ProFoam®



C1002-2W
37,5 x 25,7 x 37,5 cm
ProFoam®



C5000-4W
24 x 13 x 24 cm
ProFoam®

KOLUMNY

COLUMNS | SÄULEN | COLONNES



C5001-4W
28 x 14,5 x 28 cm
ProFoam®



C5002-4W
31 x 16 x 31 cm
ProFoam®

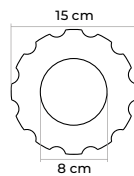

C3000W
H: 239,5 cm
ProFoam®

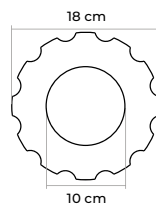

C3001W
H: 239,5 cm
ProFoam®

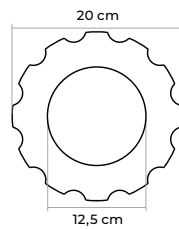

C3002W
H: 239,5 cm
ProFoam®

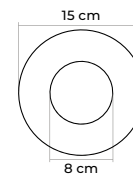

C4000W
H: 242,5 cm
ProFoam®

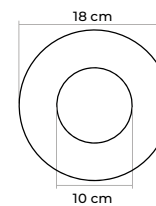

C4001W
H: 242,5 cm
ProFoam®

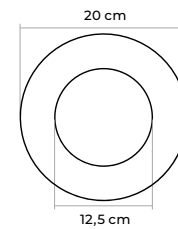

C4002W
H: 242,5 cm
ProFoam®

H: C1000-2W + C3000W + C5000-4W = 273,2 cm
 H: C1000-1W + C3000W + C5000-4W = 263 cm

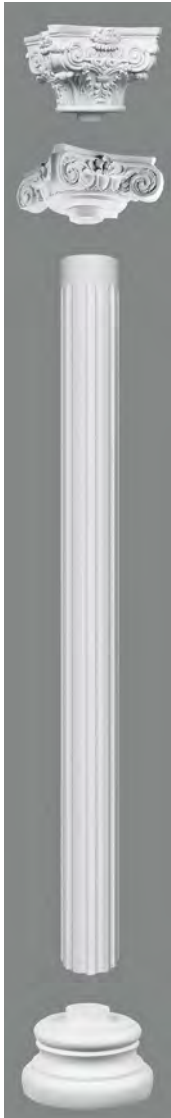

ProFoam®

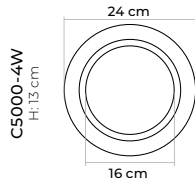
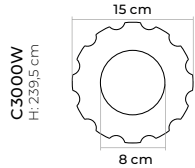
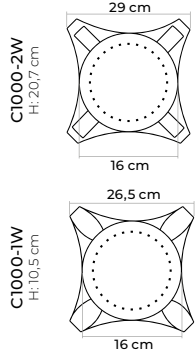

H: C1000-2W + C4000W + C5000-4W = 276,2 cm
 H: C1000-1W + C4000W + C5000-4W = 266 cm



ProFoam®

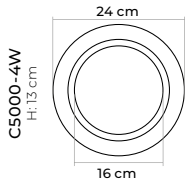
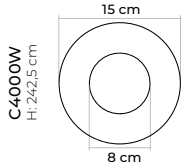
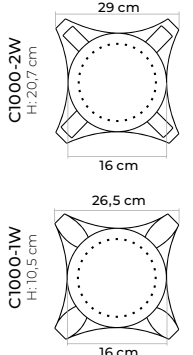

H: C1001-2W + C3001W + C5001-4W = 278,5 cm
 H: C1001-1W + C3001W + C5001-4W = 265,5 cm

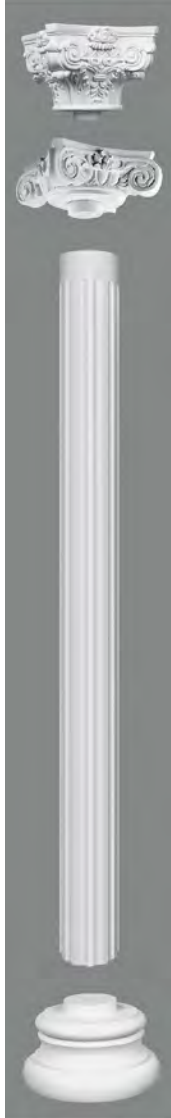

ProFoam®

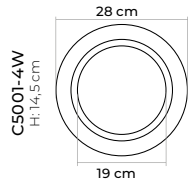
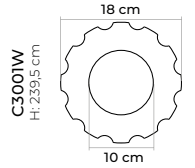
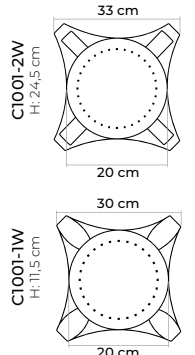

H: C1001-2W + C4001W + C5001-4W = 281,5 cm
 H: C1001-1W + C4001W + C5001-4W = 268,5 cm



ProFoam®

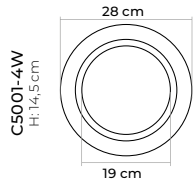
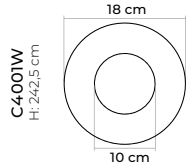
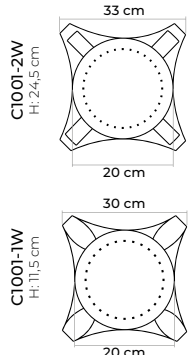

KOLUMNY

COLUMNS | SÄULEN | COLONNES

H: C1002-2W + C3002W + C5002-4W = 281,2 cm
 H: C1002-1W + C3002W + C5002-4W = 268 cm

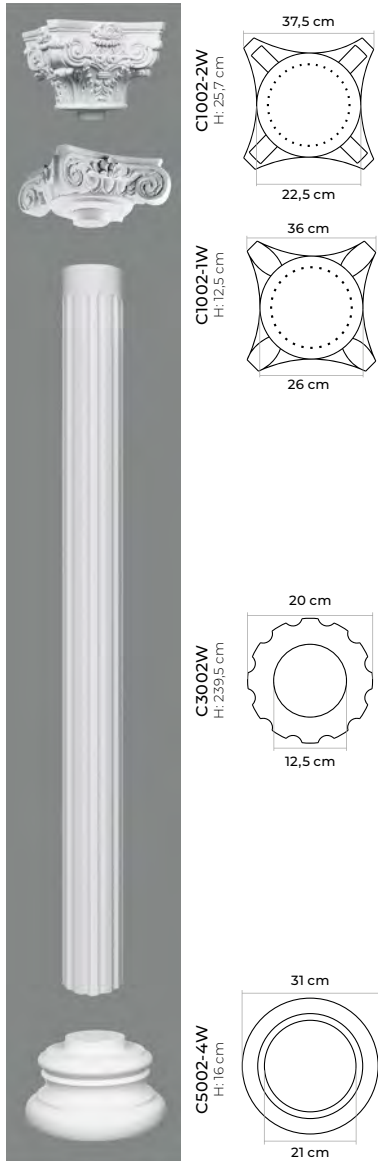

ProFoam®

H: C1002-2W + C4002W + C5002-4W = 284,2 cm
 H: C1002-1W + C4002W + C5002-4W = 271 cm

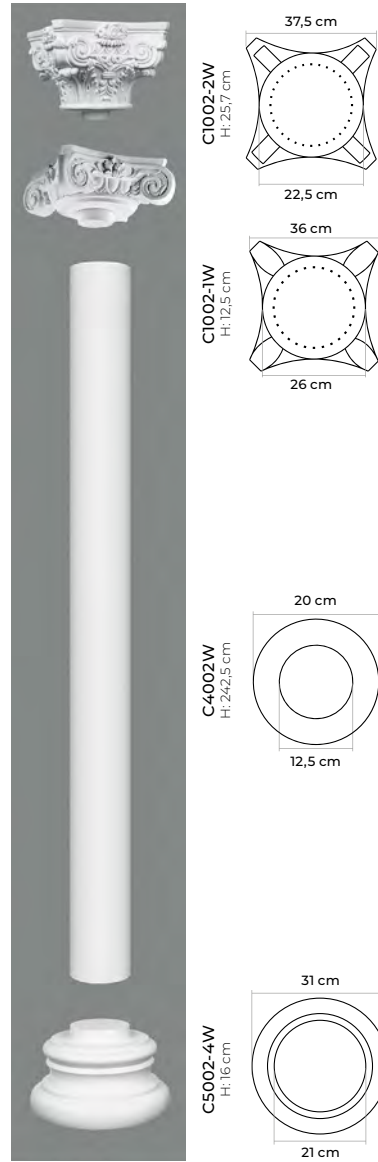

ProFoam®

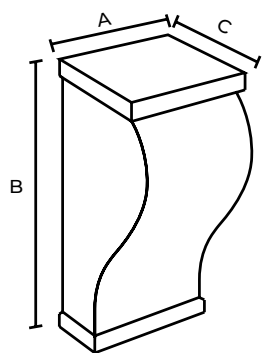

A x B x C (cm)



C1000-1H
26,5 x 10,5 x 13,2 cm
ProFoam®



C1001-1H
30 x 11,5 x 15 cm
ProFoam®



C1002-1H
36 x 12,5 x 18 cm
ProFoam®



C1000-2H
29 x 20,7 x 14,5 cm
ProFoam®



C1001-2H
33 x 24,5 x 16,5 cm
ProFoam®



C1002-2H
37,5 x 25,7 x 18,7 cm
ProFoam®



C5000-4H
24 x 13 x 12 cm
ProFoam®

PÓLKOLUMNY

HALF COLUMNS | HALBSÄULEN | DEMI COLONNES



C5001-4H
28 x 14,5 x 14 cm
ProFoam®



C5002-4H
31 x 16 x 15,5 cm
ProFoam®

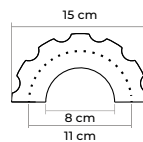
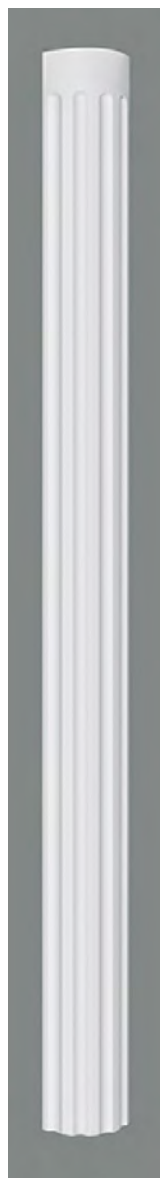

C3000H
H: 239,5 cm
ProFoam®

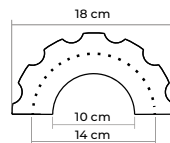

C3001H
H: 239,5 cm
ProFoam®

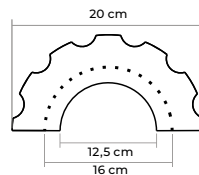

C3002H
H: 239,5 cm
ProFoam®

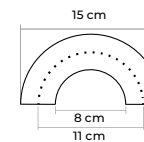

C4000H
H: 242,5 cm
ProFoam®

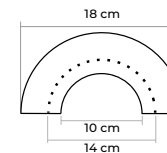

C4001H
H: 242,5 cm
ProFoam®

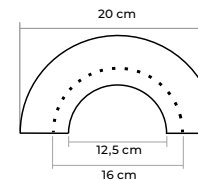

C4002H
H: 242,5 cm
ProFoam®

H: C1000-2H + C3000H + C5000-4H = 273,2 cm
 H: C1000-1H + C3000H + C5000-4H = 263 cm

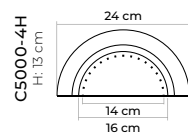
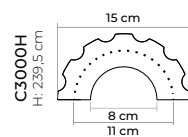
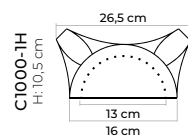
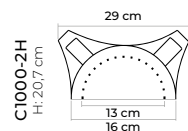
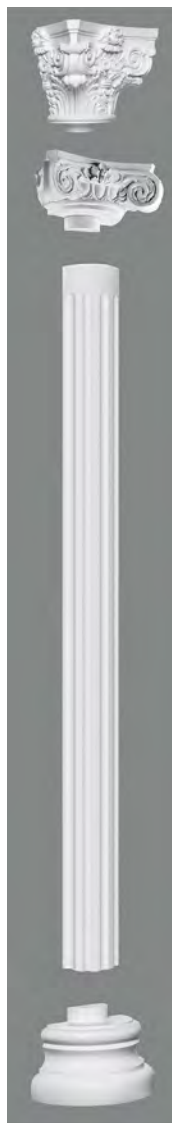

ProFoam®

H: C1000-2H + C4000H + C5000-4H = 276,2 cm
 H: C1000-1H + C4000H + C5000-4H = 266 cm

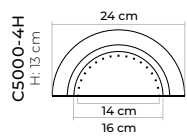
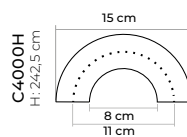
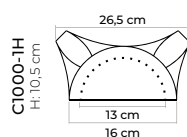
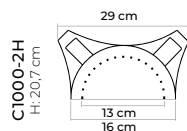

ProFoam®

H: C1001-2H + C3001H + C5001-4H = 278,5 cm
 H: C1001-1H + C3001H + C5001-4H = 265,5 cm

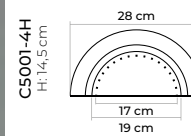
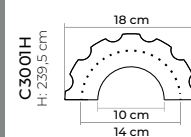
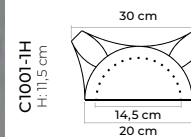
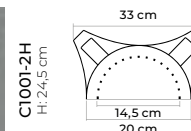
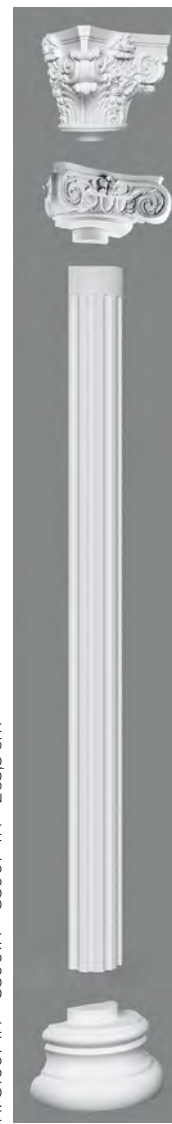

ProFoam®

H: C1001-2H + C4001H + C5001-4H = 281,5 cm
 H: C1001-1H + C4001H + C5001-4H = 268,5 cm

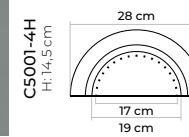
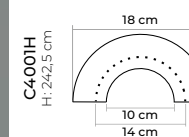
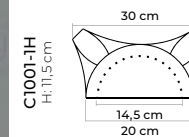
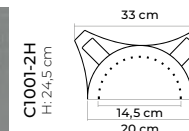

ProFoam®

PÓLKOLUMNY

HALF COLUMNS | HALBSÄULEN | DEMI COLONNES

H: C1002-2H + C3002H + C5002-4H = 281,2 cm
 H: C1002-1H + C3002H + C5002-4H = 268 cm

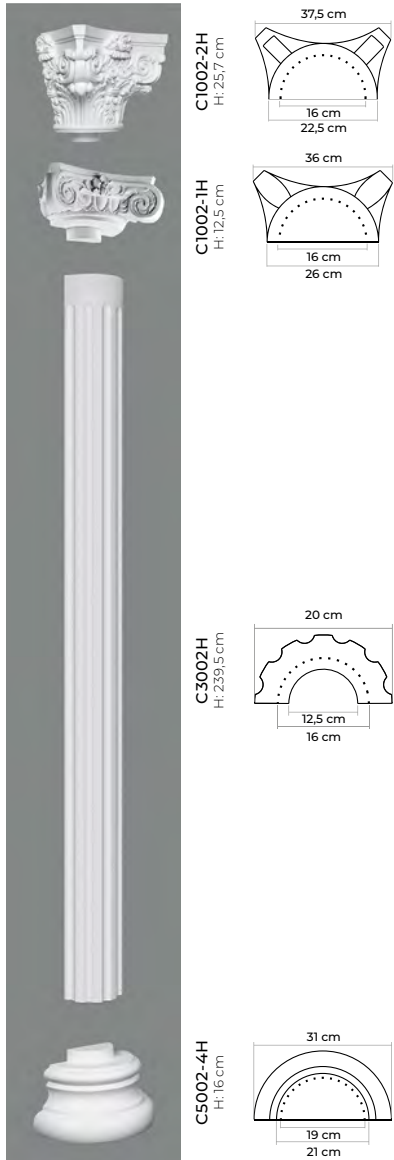

ProFoam®

H: C1002-2H + C4002H + C5002-4H = 284,2 cm
 H: C1002-1H + C4002H + C5002-4H = 271 cm

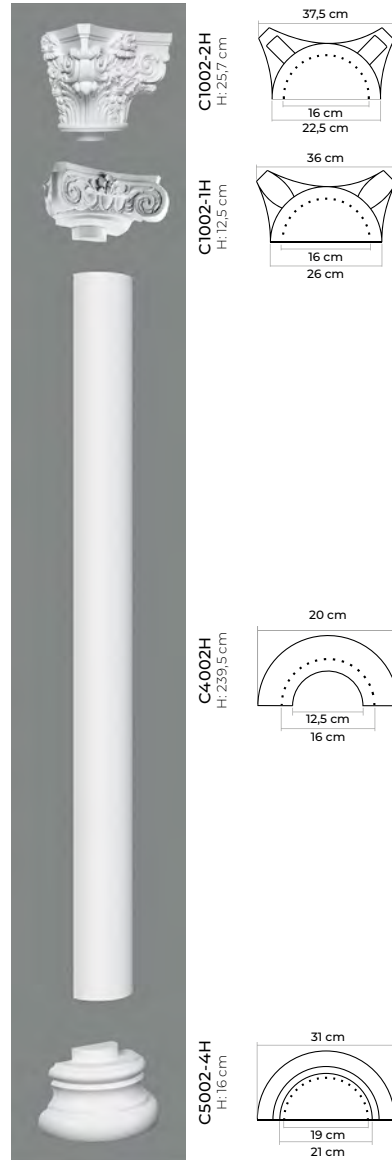

ProFoam®

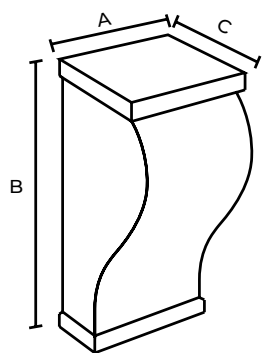

A x B x C (cm)



D5002
8,3 x 8,3 x 3 cm
ProFoam®



D3016
9,7 x 9,7 x 3,5 cm
ProFoam®



D3542
9,7 x 9,7 x 3 cm
ProFoam®



D3543
9,7 x 9,7 x 4 cm
ProFoam®



D3008
26 x 8 x 7 cm
ProFoam®



D3023
44,5 x 18,2 x 6,7 cm
ProFoam®



D3502
21,5 x 13,5 x 5,5 cm
ProFoam®

PILASTRY

PILASTERS | PILASTER | PILASTRES

**D3533**

31,7 x 16,8 x 8 cm

ProFoam®

**D3503**

31,7 x 16,8 x 8 cm

ProFoam®

**D3505**

40,7 x 34,5 x 9,5 cm

ProFoam®

**D3007**

30,8 x 17,5 x 8,8 cm

ProFoam®

**D3024**

33,5 x 15,8 x 7 cm

ProFoam®

**D3017**

9,7 x 18 x 3 cm

ProFoam®

**D3544**

9,5 x 25,2 x 3 cm

ProFoam®

**D3519**

9,5 x 25 x 4 cm

ProFoam®



D3509
14 x 29,5 x 4,5 cm
ProFoam®



D3012
11,4 x 30 x 3,3 cm
ProFoam®



D3011
13,5 x 25,5 x 3,7 cm
ProFoam®



D5003
8 x 31,5 x 3 cm
ProFoam®



D3010
19,5 x 35,5 x 3 cm
ProFoam®



D3003
28,8 x 64 x 6 cm
ProFoam®

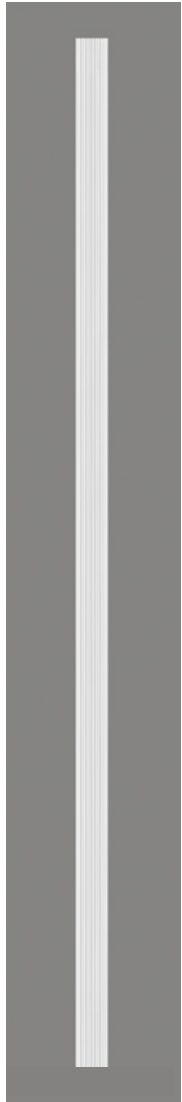

MDD412
240 x 7,5 x 1,8 cm

ProFoam®

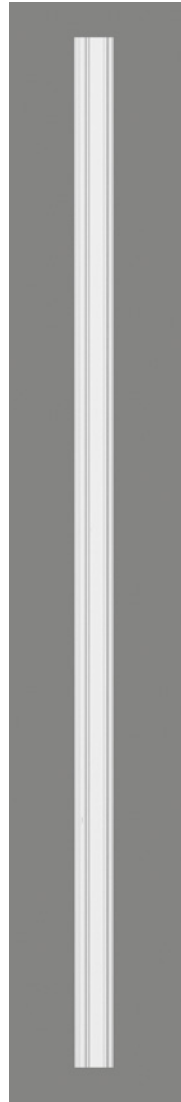

D1511
240 x 9,3 x 3,2 cm

ProFoam®

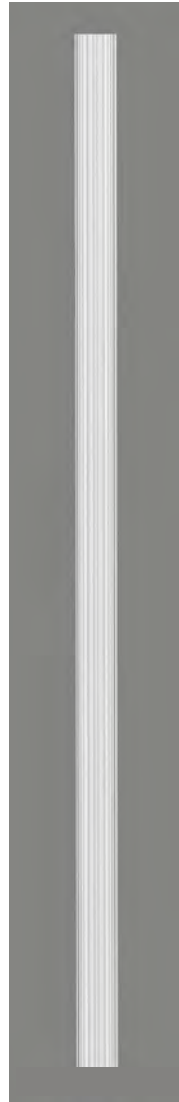

D1541
240 x 9,7 x 2,2 cm

ProFoam®

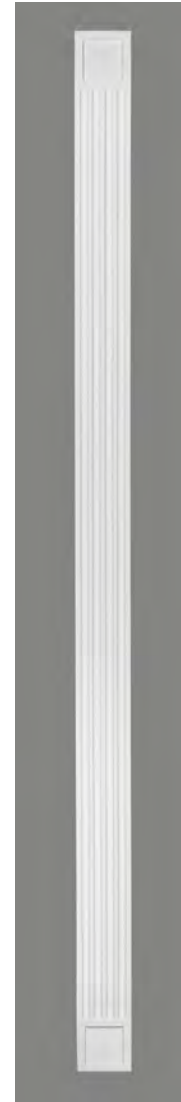

D1500
240 x 13 x 2,1 cm

ProFoam®

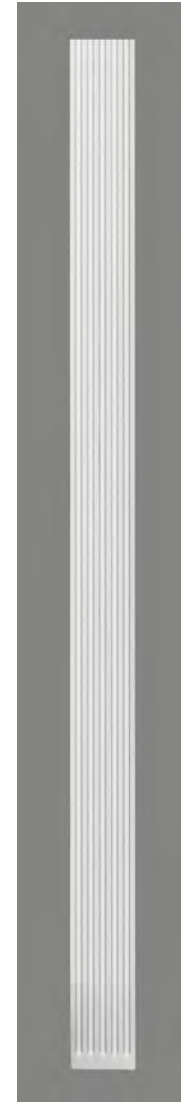

D1501
200 x 13 x 1,5 cm

ProFoam®

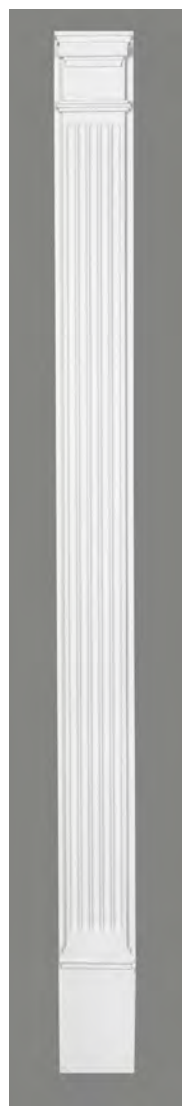

D1504
216 x 16,5 x 7 cm

ProFoam®

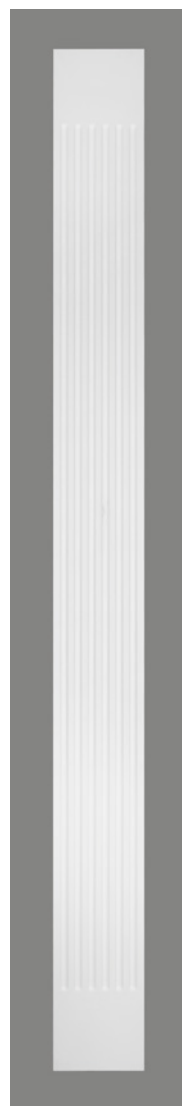

D1523
200 x 16,5 x 1,8 cm

ProFoam®

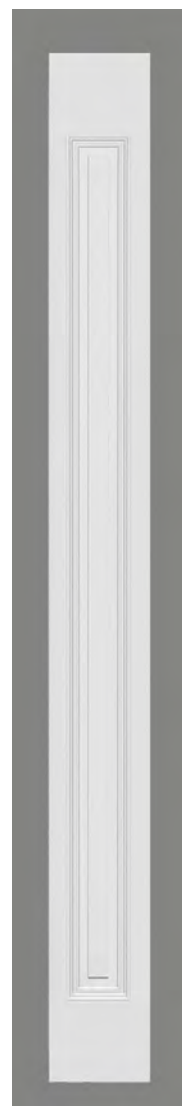

D1515
200 x 19,7 x 2 cm

ProFoam®

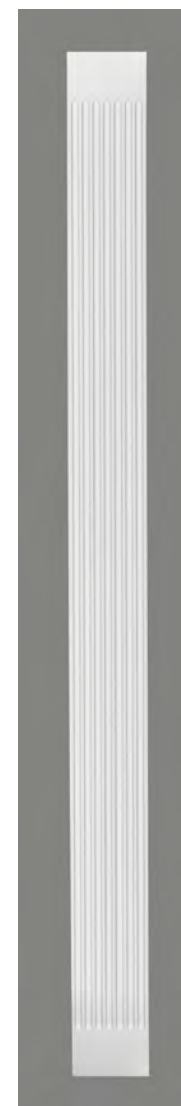

D1516
220 x 19,7 x 2 cm

ProFoam®



D1518
200 x 25 x 3 cm

ProFoam®

PILASTRY

PILASTERS | PILASTER | PILASTRES

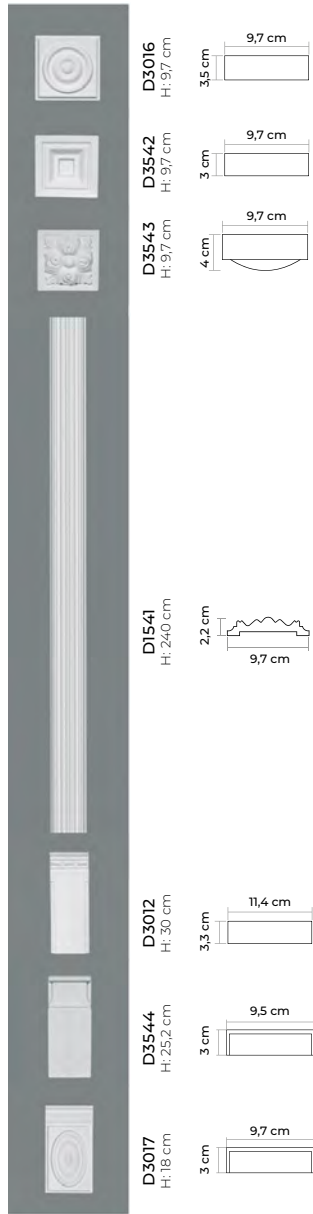
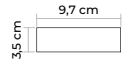
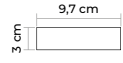
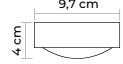
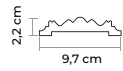
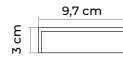
D3016
Ht: 9,7 cmD3542
Ht: 9,7 cmD3543
Ht: 9,7 cmD1541
Ht: 240 cmD3012
Ht: 30 cmD3544
Ht: 25,2 cmD3017
Ht: 18 cm

ProFoam®

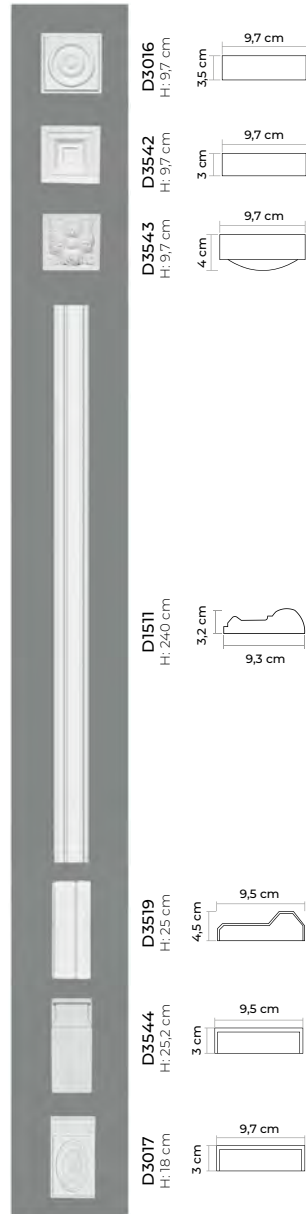
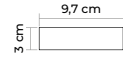
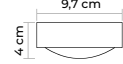
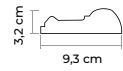
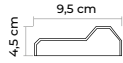
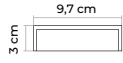
D3016
Ht: 9,7 cmD3542
Ht: 9,7 cmD3543
Ht: 9,7 cmD1511
Ht: 240 cmD3519
Ht: 25 cmD3544
Ht: 25,2 cmD3017
Ht: 18 cm

ProFoam®

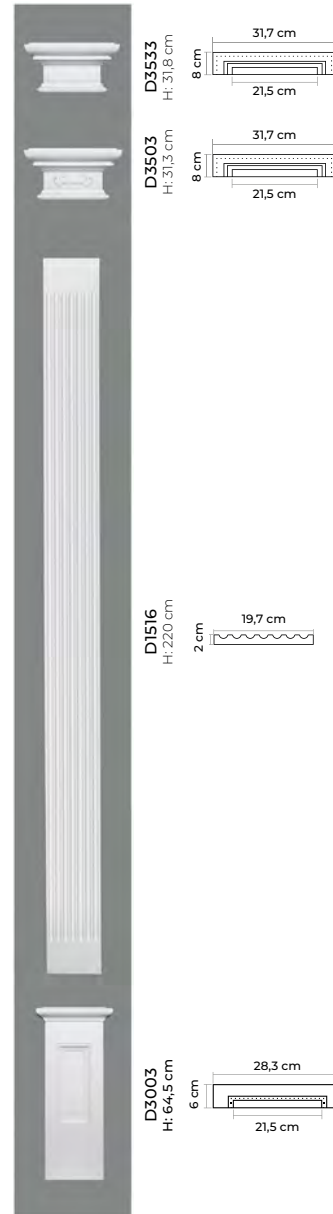
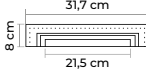
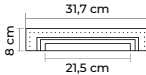
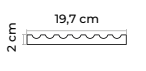
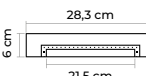
D3533
Ht: 31,8 cmD3503
Ht: 31,3 cmD1516
Ht: 220 cmD3003
Ht: 64,5 cm

ProFoam®

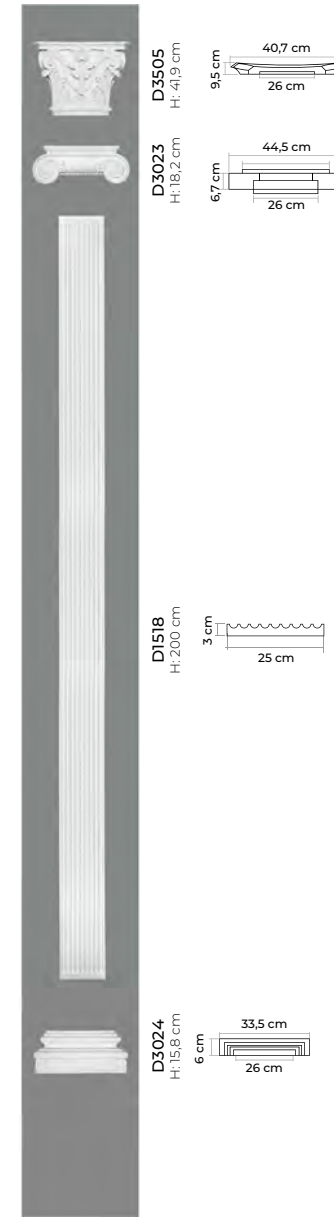
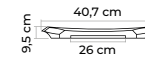
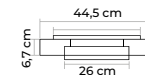
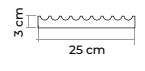
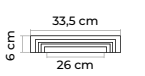
D3505
Ht: 41,9 cmD3023
Ht: 18,2 cmD1518
Ht: 200 cmD3024
Ht: 15,8 cm

ProFoam®

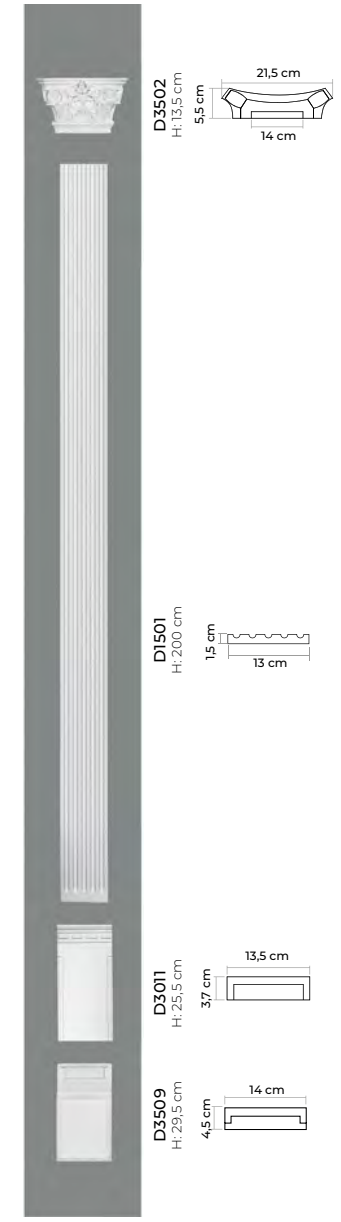
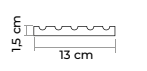
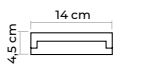
D3502
Ht: 13,5 cmD1501
Ht: 200 cmD3011
Ht: 25,5 cmD3509
Ht: 29,5 cm

ProFoam®



D1504
H: 216 cm

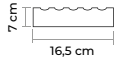

ProFoam®

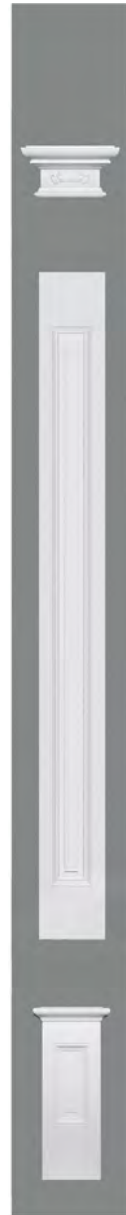

D3503
H: 31,3 cm

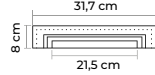

D1515
H: 200 cm

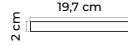

D3003
H: 28,8 cm

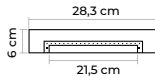

ProFoam®



D3008
H: 8 cm

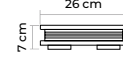

D3007
H: 9 cm

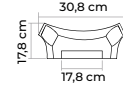

D1523
H: 200 cm

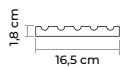

D3010
H: 35,5 cm

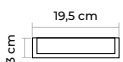

ProFoam®



D3016
H: 9,7 cm

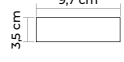

D3542
H: 9,7 cm

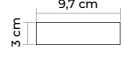

D3543
H: 9,7 cm



MDD412
H: 240 cm

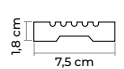

D5003
H: 31,5 cm

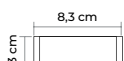

ProFoam®

PILASTRY

PILASTERS | PILASTER | PILASTRES



1. MD002 2. MD358

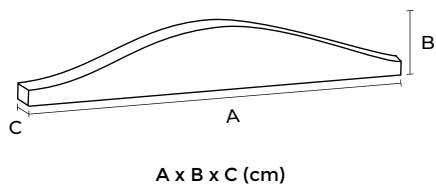

D2531
124/110 x 25 x 8,8/2,3 cm
ProFoam®

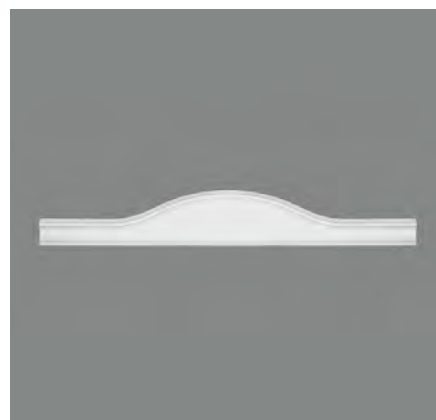

D2512
125 x 19,5 x 3 cm
ProFoam®



D3514
15,5 x 11,5 x 2 cm
ProFoam®

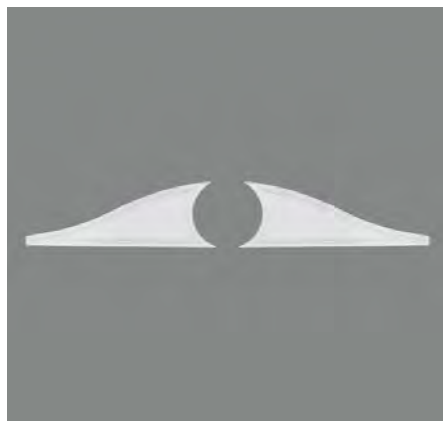

D3515
31,5 x 11 x 0,6 cm
ProFoam®



D3516
43 x 11 x 1 cm
ProFoam®



D3517
32 x 13 x 1,5 cm
ProFoam®



D3518
23 x 13,5 x 3 cm
ProFoam®

ELEMENTY DEKORACYJNE

DECORATIVE ELEMENTS | ZIERELEMENTE | ÉLÉMENTS DÉCORATIFS



C8031
15,6 x 24,2 x 12 cm
ProFoam®



C8032
13,8 x 20 x 6,5 cm
ProFoam®



C8035
10,5 x 14 x 5,5 cm
ProFoam®



ProFoam®

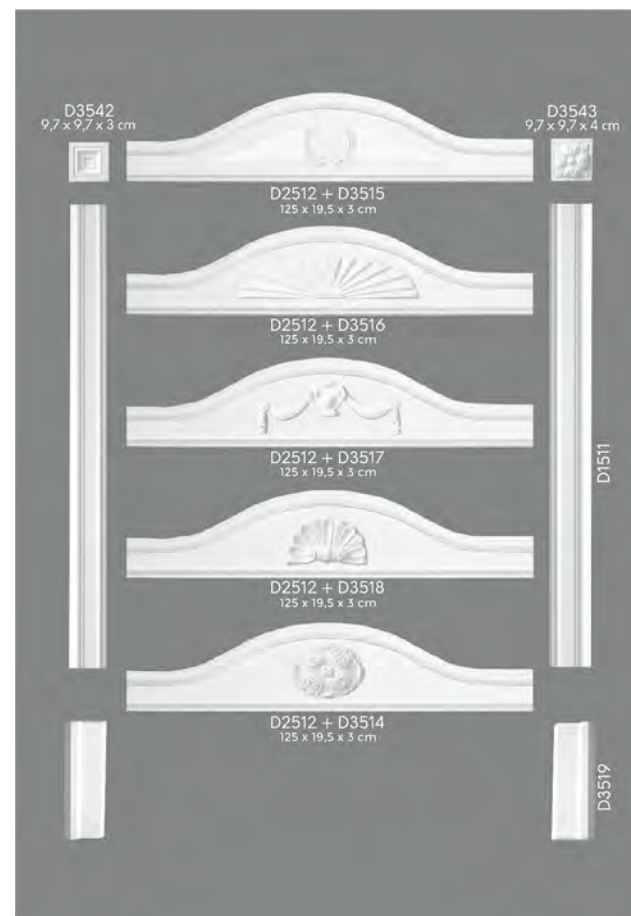

ProFoam®



MD359E

240 x 7 x 1,6 cm

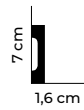
PolyForce® 

MD008E

240 x 8 x 1,7 cm

PolyForce® 

MD258E

240 x 8,1 x 1 cm

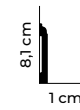
PolyForce® 

MD094E

240 x 9,4 x 1,2 cm

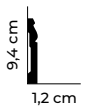
PolyForce® 



MD009E

240 x 10 x 1,7 cm

PolyForce® 



MD356E

240 x 11 x 1,5 cm

PolyForce® 

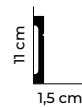

AKCESORIA

Accessories | Zubehör | D'accessoires



1. MDD314 2. D1511 3. MDD346 4. MDD413 5. MD360

AKCESORIA

montaż produktów nigdy nie był łatwiejszy

Accessories | Zubehör | D'accessoires

PL

Aby maksymalnie uprościć montaż produktów, stworzyliśmy gamę akcesoriów, dzięki którym proces instalacji będzie szybki, łatwy i skuteczny.

ENG

To simplify the assembly of products as much as possible, we have created a range of accessories that will make the installation process quick, easy and effective.

DE

Für unsere Produkte bieten wir eine Vielzahl von hilfreichem Zubehör an, welches die Montage einfach, schnell und effizient ermöglicht.

FR

Afin de faciliter le montage de nos produits, nous avons créé une gamme d'accessoires pour rendre le processus d'installation rapide, facile et efficace.

NEW



330 g

MASA SZPACHLOWA MARDOM DECOR

MARDOM DECOR FLEX FILLER

MARDOM DECOR SPACHTELMASSE

MASTIC FLEXIBLE MARDOM DECOR

PL

Elastyczna masa szpachlowa idealna do łączenia sztukaterii. Do stosowania wewnątrz pomieszczeń na twardych, suchych, czystych i przyczepnych powierzchniach. Do wypełniania ubytków, pęknięć i szczelin o głębokości do 5 mm. Można nakładać na: gips, płyty gipsowe, kafle gipsowe, beton, beton komórkowy, cement, cegłę, kamień, starą malowaną powierzchnię. Produkt gotowy do użycia.

- Odporna na wilgoć
- Łatwe nakładanie i szlifowanie
- Zapobiega powstawaniu pęknięć

DE

Eine elastische Spachtelmasse, ideal zum Ausbessern und füllen von Stuck. Zu verwenden in Innenräumen auf festen, trockenen, sauberen und haftenden Oberflächen. Zum Auffüllen von Vertiefungen, Rissen und Fehlstellen bis zu einer Tiefe von 5 mm. Anwendbar auf allen unseren Produkten, Gips, Gipsplatten, Gipsfliesen, Beton, Porenbeton, Schaumbeton, Zellbeton, Zement, Ziegelstein, Stein und gestrichene Oberflächen. Das Produkt ist sofort gebrauchsfertig.

- Feuchtigkeitsbeständig
- Leichtes auftragen und schleifen
- Beugt Rissbildungen vor

EN

Flex filler - ideal for jointing mouldings. For indoor use on hard, dry, clean and adhesive surfaces. To fill cavities, cracks and fissures up to 5 mm deep. It can be applied on: plaster, plaster boards, plaster tiles, concrete, autoclaved aerated concrete, cement, brick, stone, old paint. Ready to use.

- Resistant to moisture
- Easy to apply and sand
- Prevents cracks from forming

FR

Mastic flexible, idéal pour assembler les cimaises. Pour une utilisation en intérieur sur des surfaces dures, sèches, propres et adhésives. Pour le remplissage de cavités, fissures et interstices jusqu'à 5 mm de profondeur. Peut être appliqué sur: du plâtre, plaques de plâtre, carreaux de plâtre, béton, béton cellulaire, ciment, brique, pierre, ancienne surface peinte. Le produit est prêt à l'emploi.

- résistant à l'humidité
- facile à appliquer et à poncer
- empêche la formation de fissures



290 ml



300 ml

MARDOM MAX

PL

Klej montażowy, hybrydowy, polimerowy, o maksymalnej sile wiązania wewnątrz i na zewnątrz pomieszczeń, na powierzchniach porowatych i gładkich. Błyskawiczna szybkość chwytu – już po 8 sekundach. Jedno opakowanie kleju wystarcza na przyklejenie średnio 8 metrów listwy. Kolor biały.

DE

Der Hybridkleber - mit maximaler Anfangshaftung - ist sowohl im Innen- und Außenbereich und auch auf rauen und glatten Oberflächen einsetzbar. Es tritt eine sofortige Haftung in nur 8 Sekunden ein. Farbe Weiß.

MARDOM FIX PRO

PL

Klej montażowy na bazie wody, do stosowania wewnątrz pomieszczeń. Służy do klejenia listwy do ściany lub sufitu. Charakteryzuje się trwałym i mocnym wiązaniem. Może być stosowany na powierzchniach porowatych. Jedno opakowanie kleju wystarcza na przyklejenie średnio 8 metrów listwy. Kolor biały.

DE

Ein Montagekleber der für den Innenbereich entwickelt wurde. Es zeichnet sich durch eine dauerhafte und starke Haftung aus, ist schnell trocknend und geruchlos. Das Produkt enthält keine Lösungsmittel. Es kann auf verschiedenen Untergründen (z.B. Mineralputz, Gipskartonplatten, Holz, Beton, etc.) eingesetzt werden.

EN

Hybrid, polymer, installation adhesive with extreme bonding strength indoors and outdoors, on rough and smooth surfaces. Immediate bonding after 8 seconds. One package is enough for installation about 8 meters of the mouldings. White colour.

FR

Colle de montage, hybride, polymère, avec une force d'adhérence maximale pour une utilisation intérieure et l'extérieur, sur des surfaces poreuses et lisses (carreaux, verre). Vitesse d'adhésion ultra-rapide - après seulement 8 secondes. Un tube de colle suffit pour coller 8 mètres de moulure en moyenne. Couleur blanche.

EN

Water-based, installation adhesive for interior applications on porous surfaces. The adhesive provides long-lasting seal between mouldings and the surface (wall and ceiling). One package is enough for installation about 8 meters of the mouldings. White color.

FR

Adhésif d'assemblage à base d'eau pour une utilisation en intérieur. Il est utilisé pour coller la moulure au mur ou au plafond. Il se caractérise par une liaison durable et forte. Peut être utilisé sur des surfaces poreuses. Un paquet d'adhésif suffit pour coller en moyenne 8 mètres de moulure. Blanc. Capacité : 300 ml



MARDOM FIX EXTRA

PL

Klej na bazie poliuretanu, do spoinowania i łączenia listew między sobą. Do stosowania wewnątrz i na zewnątrz pomieszczeń. Jedno opakowanie kleju wystarcza na połączenie średnio 80 metrów listew. Klej przezroczysty.

DE

Der Kleber ist für die Stoßkantenverklebung der Mardom Decor Stuckelemente bestimmt. Das Produkt enthält keine Lösungsmittel. Der Klebstoff sorgt für eine starke und dauerhafte Verbindung. Es kann auf verschiedenen Untergründen (z.B. Mineralputz, Gipskartonplatten, Holz, Beton, etc.) eingesetzt werden.

EN

An adhesive designed for bonding and grouting of Mardom Decor mouldings. In addition to its adhesive properties, it also seals the bonds between the elements. The product does not contain solvents. The adhesive provides strong and solid bonding. It can be applied on various surfaces (i.a. mineral plasters, plasterboard panels, wood, concrete, etc.).

FR

Adhésif à base de polyuréthane, pour joindre et assembler les moulures entre elles. Pour un usage intérieur et extérieur. Un tube de colle suffit pour joindre en moyenne 80 mètres de moulures. Colle transparente.



LAKIER SATYNOWY DO MASKOWANIA ŁĄCZEŃ

SATIN VARNISH FOR MASKING JOINTS | SATINLACK | VERNIS SATIN POUR MASQUER LES JOINTS

PL

Satynowy lakier służy do maskowania łączeń listew przypodłogowych Mardom Decor Premium, które są pokryte ekskluzywną satynową powłoką.

DE

Der Satinlack wird zum Abdecken von Mardom Decor Premium Sockelleisten verwendet, die mit einer exklusiven Satinbeschichtung versehen sind.

EN

Satin varnish is used for masking Mardom Decor Premium skirting boards, which are covered with an exclusive satin coating.

FR

Le vernis satiné est utilisé pour masquer les jointures des moulures Mardom Decor Premium, qui sont recouvertes d'un revêtement satiné exclusif.

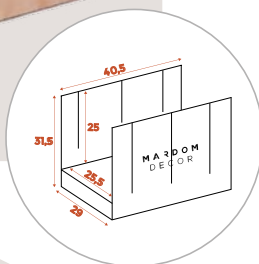

SKRZYŃKA UCIOSOWA

MITER BOX | MITER BOX | LA BOITE A ONGLETS

PL

Skrzynka uciosowa Mardom Decor do przycinania listew pod kątem 45 lub 90 stopni. Wykonana z wysokogatunkowego materiału.

DE

Die Mardom Decor Gehrungslade zum Schneiden von Leisten in einem Winkel von 45° oder 90°. Sie ist aus hochwertigem Material hergestellt.

EN

Mardom Decor miter box for cutting mouldings at an angle of 45° or 90°. Made of highgrade material.

FR

Boîte à onglets Mardom Decor pour couper les moulures à 45 ou 90 degrés. Fabriqué à partir de matériau de haute qualité.



TAŚMA ALUMINIOWA

ALUMINIUM TAPE | ALUMINIUMBAND | RUBAN ALUMINIUM

PL

Taśma aluminiowa służy do montażu listew oświetleniowych. Szerokość 5 cm. Długość: 45 m.

DE

Das Aluminium-Klebeband wird zur Befestigung von Lichtbändern verwendet. Breite 5 cm. Länge: 45 m.

EN

Aluminium tape, used for the installation of lighting moldings. Width: 5 cm. Length: 45 m.

FR

Le ruban en aluminium est utilisé pour l'assemblages les corniches lumineuses. Largeur 5 cm. Longueur: 45 m.



SŁUPEK EKSPOZYCYJNY

TOWER DISPLAY | MUSTER TOWER | TOUR D'EXPOSITION

224 x 59,5 cm

PL

Tekturowy słupek to ekspozytor, dzięki któremu na niewielkiej powierzchni zaprezentujesz wszystkie listwy.

DE

Der Muster Tower ist ein Ausstellungsstück, dank dem Sie alle Leisten auf einer kleinen Fläche präsentieren können.

EN

The cardboard tower is a display that allows you to present all the mouldings on a small area.

FR

La tour en carton est un présentoir qui permet de proposer toutes les moulures sur une petite surface.

TABLICA „ELITE”

„ELITE” BOARD | „ELITE”-ANZEIGETAFEL | PRESENTOIT „ELITE”

150 x 66 cm

PL

Prezentuje wszystkie listwy przypodłogowe.

DE

Die „Elite”-Anzeigetafel präsentiert alle Sockelleisten.

EN

The board presents all skirting boards.

FR

Il présente toutes les plinthes.



TABLICA „PREMIUM”

„PREMIUM” BOARD | „PREMIUM”-ANZEIGETAFEL | PRESENTOIR „PREMIUM”

133 x 45 cm

PL

Prezentuje wybrane listwy przypodłogowe pokryte satynową powłoką SupremeSatin®. Występuje w komplecie ze sztalugą.

DE

Die „Premium“-Anzeigetafel präsentiert ausgewählte Sockelleisten mit der Satinierung SupremeSatin®-Beschichtung. Es wird komplett mit einer Staffelei geliefert.

EN

The board presents selected skirting boards covered with SupremeSatin® coating. It comes complete with an easel.

FR

Il propose une sélection de moulures recouvertes d'un revêtement satiné SupremeSatin®. Il est livré avec un chevalet.



TABLICA „PRESTIGE”

„PRESTIGE” BOARD | „PRESTIGE”- ANZEIGETAFEL | PRESENTOIR „PRESTIGE”

150 x 94 cm

PL

Prezentuje wybrane listwy ścienne, sufitowe, karniszowe i oświetleniowe.

DE

Die „Prestige“-Anzeigetafel präsentiert ausgewählte Wand-, Decken-, Vorhangschiene und Beleuchtungsleisten.

EN

The board presents selected panel mouldings, cornice mouldings, curtain profiles and lighting mouldings.

FR

Il propose une sélection de moulures, de corniches de plafonds, cache tringles à rideaux et d'éclairage.



TABLICA „BESTSELLERY”

„BESTSELLERS” BOARD | „BESTSELLERY”-ANZEIGETAFEL | PRESENTOIR „BESTSELLERS”

150 x 50 cm

PL

Prezentuje listwy najczęściej wybierane przez klientów.

DE

Die „Bestsellery”-Anzeigetafel präsentiert die Leisten, die am häufigsten von Kunden gewählt werden.

EN

The board presents the mouldings that are the top-choice of the customers.

FR

Il propose les moulures les plus souvent choisies par les clients.

WALIZKI ALUMINIOWE

ALUMINIUM SUITCASES | DIE ALUMINIUMKOFFER | VALISES EN ALUMINIUM

PL

Przenośne narzędzie, idealne dla architektów. Mała walizka zawiera listwy podłogowe. Duża walizka zawiera wybrane listwy ścienne, sufitowe, karniszowe i oświetleniowe.

Duża walizka: 49 x 64 x 17,5 cm

Mała walizka: 41,5 x 56,5 x 16,5 cm

DE

Die Aluminiumkoffer eignen sich ideal für Bauprojekte und Architekten. Der kleine Koffer enthält hierbei Sockelleisten. Der große Koffer enthält ausgewählte Wand-, Decken-, Gardinen- sowie LED taugliche Lichtleisten.

Große Koffer: 49 x 64 x 17,5 cm

Kleine Koffer: 41,5 x 56,5 x 16,5 cm

EN

A portable tool, ideal for architects. The small suitcase contains skirting boards. The large suitcase contains selected wall mouldings, cornice mouldings, curtain profiles and lighting mouldings.

Big suitcase: 49 x 64 x 17,5 cm

Small suitcase: 41,5 x 56,5 x 16,5 cm

FR

Un outil portable, parfait pour les architectes. La petite valise contient des plinthes. La grande valise contient une sélection de moulures, corniches de plafond, cache tringles à rideaux et d'éclairage.

Grande valise: 41,5 x 56,5 x 16,5 cm

Petite valise: 29,5 x 41,5 x 13,5 cm



WALIZKA TEKSTUROWA

CARDBOARD SUITCASE | DAS KARTONSTECKTASCHE | VALISE EN CARTON

133 x 45 cm

PL

Lekkie i kompaktowe rozwiązanie dla architektów. Zawiera katalog oraz listwy najczęściej wybierane przez klientów.

DE

Der praktische, stabile und leichte Karton ist die kompakte Lösung für Architekten. Er enthält eine Auswahl der gängigsten Sockelleisten, sowie einen kompletten Produktkatalog.

EN

A light and compact solution for architects. It contains a catalog and mouldings most frequently chosen by customers.

FR

Une solution légère et compacte pour les architectes. Elle contient un catalogue et les moulures les plus souvent choisis par les clients.

INSTRUKCJA MONTAŻU

INSTALLATION | INSTALLATION | INSTALLATION



- PL**
1. Listwy powinny być aklimatyzowane przez około 48 godzin w pomieszczeniu, w którym będą montowane.
 2. Przykładamy listwę do rogu sufitu i ściany w pozycji montażowej.

- EN**
1. The mouldings should be acclimated for approximately 48 hours in the room in which they are installed.
 2. Place the moulding in the corner of the ceiling and wall in the desired installation position.

- DE**
1. Die Leisten sollten zur Aklimatisierung 48 Stunden bei Raumtemperatur gelagert werden.
 2. Die Leiste an der Wand-/Deckenfläche in die gewünschte Position bringen. Die zweite Leiste dagegensetzen.

- FR**
1. Les plinthes doivent être acclimatées pendant environ 48 heures dans la pièce de destination.
 2. Placez la moulure dans l'angle du plafond et du mur dans la position d'installation souhaitée.



- PL**
3. Obrysowujemy dolną i górną krawędź wzdłuż listwy aż do przeciwległej ściany, na której będziemy montowali drugą listwę.
 4. Analogicznie postępujemy na drugiej prostopadłej ścianie.

- EN**
3. Outline the top and bottom edge along the moulding all the way to the opposite wall, where the next moulding will be installed.
 4. Repeat the same actions on the perpendicular wall.

- DE**
3. Markieren Sie nun die entlang der zweiten Leiste mit einem Bleistift die Schnittfläche.
 4. Das wiederholen Sie verkehrt herum nun auch mit der zweiten Leiste.

- FR**
3. Tracez le contour du bord supérieur et inférieur le long de la moulure jusqu'au mur opposé, où la moulure suivante sera installée.
 4. Répétez les mêmes actions sur le mur perpendiculaire.



- PL**
5. Uzyskujemy w ten sposób obrys i linie (kąty) montażu i cięcia listew względem siebie. Dolny punkt linii cięcia listwy znajduje się w samym narożniku tj. w punkcie łączenia dwóch ścian. Górny punkt linii cięcia listwa znajduje się na narysowanym w pkt 3 przecięciu linii krawędzi górnej listew (na suficie) pod kątem 90 stopni.

- EN**
5. In this way we obtain an outline and the lines (angles) for the installation and cutting of the mouldings in relation to each other. The lower point of the moulding cutting line is located in the corner, that is, at the point where the two walls join. The upper point of the moulding cutting line is located at the point (drawn in point 3) where the lines of the upper edges of the mouldings (on the ceiling) intersect at an angle of 90 degrees.

- DE**
5. Auf diese Weise haben Sie die genauen Schnittpunkte, welche mit einer Gehrungssäge oder auch Kappsäge passgenau geschnitten werden können. Der Winkel beträgt 90 Grad.

- FR**
5. De cette façon, nous obtenons un contour et les lignes (angles) pour l'installation et la découpe des moulures les unes par rapport aux autres. Le point inférieur de la ligne de coupe du moulage est situé dans le coin, c'est-à-dire au point de jonction des deux murs. Le point supérieur de la ligne de coupe des moulures est situé au point (dessiné au point 3) où les lignes des bords supérieurs des moulures (au plafond) se croisent à un angle de 90 degrés.



PL
 — 6. Cięcia dokonujemy na ukośnicy lub na odpowiednio dużym w stosunku do wysokości listwy korycie uciosowym.

EN
 — 6. The cutting is performed on a mitre or a mitre box sufficiently large in relation to the height of the moulding.

DE
 — 6. Achten Sie bitte auf eine ausreichend große Gehrun-
 gslade, in welche die Profile hineinpassen.

FR
 — 6. La découpe est effectuée à l'aide d'une boîte à on-
 glets suffisamment grande par rapport à la hauteur
 de la moulure.

PL
 — 7. Klej Fix Pro nakładamy po długości na lewej stronie
 profilu w miejscu styku z klejonym podłożem.
 8. Klej nakładamy falście (ewentualnie liniowo w przy-
 padku niewielkich listew o małej powierzchni klejenia).

EN
 — 7. The Fix Pro adhesive is applied along the length on the
 left side of the profile in the point of contact with the
 glued surface.
 8. The adhesive is applied in sinuous lines (or in straight
 lines in the case of small mouldings with small bonding
 area).

DE
 — 7. Nun den Mardom Fix Pro Kleber auf die vorgesehenen
 Klebeflächen auftragen.
 8. Der Kleber sollte wellenförmig aufgetragen werden. Bei kle-
 inen Leisten mit geringer Klebefläche auch linear.

FR
 — 7. Appliquez l'adhésif Fix Pro sur la longueur côté gauche du
 profil au point de contact avec la surface de destination.
 8. La colle est appliquée en vague (ou en ligne droite dans le
 cas de petites moulures avec une petite zone de collage).

PL
 — 9. Listwę mocno dociskamy do podłoża.
 Zbieramy nadmiar wyciśniętego kleju.

EN
 — 9. Firmly press the moulding against the surface.
 Remove the excess glue that was squeezed out.

DE
 — 9. Nun die Leiste fest an die endgültige Position
 drücken und den überschüssigen Kleber mit
 einem Spachtel entfernen.

FR
 — 9. Appliquez fermement la moulure contre le
 mur. Retirez l'excès de colle qui a été pressé.

INSTRUKCJA MONTAŻU

INSTALLATION | INSTALLATION | INSTALLATION



PL 10. Postępujemy analogicznie w przypadku drugiej ściany. Przykładamy i doklejamy drugi profil, odpowiednio docięty do łączonej listwy.

EN 10. Repeat the same actions on the second wall. Place and glue the second profile, properly cut to match the joined moulding.

DE 10. Diesen Vorgang wiederholen Sie mit der 2. Leiste, wobei darauf zu achten ist, dass Sie für die Stoßverbindung der beiden Leisten den Mardom Fix Extra Kleber verwenden.

FR 10. Procédez de la même pour le deuxième mur. Appliquez et collez le deuxième profil, coupé de manière appropriée pour correspondre à la moulure jointe.



PL 11. Łączenie dwóch listew wypełniamy klejem Fix Extra, dociskając następane do siebie obie listwy. Nadmiar kleju zbieramy. Po 1-2 godzinach należy skontrolować i ewentualnie zebrać nadmiar kleju Fix Extra (ponieważ potrafi w wyniku reakcji z ProFoam® wypłynąć na wierzch).

EN 11. Fill the joint between the two mouldings with Fix Extra adhesive and press both mouldings together. Collect the excess adhesive. After 1-2 hours it is necessary to check and possibly collect excess Fix Extra adhesive (as it can may come out on the surface due to a reaction with ProFoam®).

DE 11. Nach dem zusammen drücken der Leisten entfernen Sie den überschüssigen Fix Extra Kleber sorgfältig mit einem scharfen Spachtel. In der Aushärtung quillt der Kleber leicht nach, so dass Sie nach 1 bis 2 Stunden den überschüssigen Kleber erneut abziehen sollten. Nach endgültiger Aushärtung ist dieser nicht schleifbar!

FR 11. Remplissez la jonction deux moulures avec de la colle Fix Extra, en pressant les deux moulures l'une contre l'autre. Retirez l'excès de colle. Après 1 à 2 heures, vérifiez et, si nécessaire, retirez l'excédent d'adhésif Fix Extra (car il peut sortir à la surface en raison d'une réaction avec ProFoam®).



PL 12. Szczelinę pomiędzy ścianą/sufitem a listwą, oraz pomiędzy dwoma listwami, obrabiamy przy pomocy kleju Fix Pro. Zbieramy nadmiar kleju. Po stwardnieniu klej Fix Pro można szlifować

EN 12. Fill the gap between the wall/ceiling and the moulding, and the gap between the two mouldings with Fix Pro adhesive. Collect the excess adhesive. The Fix Pro adhesive can be grinded once it is cured.

DE 12. Zum Abschluss sämtliche noch bestehenden Fugen mit dem Mardom Fix Pro ausspritzen. Dieser kann nach der Trocknung mit allen handelsüblichen Anstrichmitteln gestrichen werden.

FR 12. Remplissez l'espace entre le mur / plafond et la moulure, ainsi que l'espace entre les deux moulures avec l'adhésif Fix Pro. Récupérez l'excès d'adhésif. L'adhésif Fix Pro peut être poncé une fois durci.



PL
13. Do końcowego maskowania i wygładzania łączeń można użyć szpachli.

EN
13. A putty knife can be used for the final masking and smoothing of the joints.

DE
13. Zur Verdichtung zwischen Leiste und Decke, bzw. Wandfläche nehmen Sie bitte auch den Mardom Fix Pro Kleber.

FR
13. Le mastic peut être utilisé pour le masquage final et le lissage des joints.



PL
W przypadku listew podłogowych inox oraz aluminium należy bardzo precyzyjnie dociąć listwę pod kątem 45 stopni.

EN
In the case of inox (stainless steel) and aluminum skirting boards, the skirting has to be precisely cut at an angle of 45 degrees.

DE
Bei den Inox-und Aluminium Sockelleisten achten Sie bitte darauf, das diese an den Stößen sauber in einem 45 Grad Winkel gesägt werden.

FR
Dans le cas des plinthes en inox et en aluminium, coupez la plinthe très précisément à un angle de 45 degrés. Le meilleur outil est la scie à 14 dents Mardom Decor.



PL
Odwiedź nas na kanale MARDOM DECOR na youtube.com

EN
Visit the MARDOM DECOR channel on youtube.com

DE
Eine anschauliche Anleitung der Verarbeitung finden Sie auch auf unserem YouTube Kanal unter Mardom Decor.

FR
Visitez-nous sur la chaîne Mardom Decor sur YouTube.

PL

Produkty Mardom Decor mogą być montowane na zewnątrz budynków i w pomieszczeniach o podwyższonej wilgotności. Konieczne jest wówczas zastosowanie kleju Mardom Fix Extra. Przy montażu na zewnątrz, produkty muszą zostać pokryte farbą zewnętrzną.

Stosując oświetlenie LED, zalecamy oklejanie listew taśmą aluminiową Mardom Decor Alu Tape dla uzyskania jeszcze lepszego efektu wizualnego. Listwa oklejona taśmą daje efekt równomiernego podświetlenia - bez miejscowego przebijania światła.

Aby zapobiec problemom z montażem, produkty należy aklimatyzować przez 24-48 godzin w pomieszczeniu, w którym będą montowane.

Zalecamy sprawdzenie wymiarów produktów przed montażem, ponieważ wartości podane w katalogu mogą nieznacznie odbiegać od rzeczywistości.

GWARANCJA

Na produkty Mardom Decor obowiązuje 12 miesięcy gwarancji pod warunkiem zastosowania klejów sugerowanych przez firmę Mardom Sp. z o.o. oraz spełnienia wszystkich warunków dotyczących instrukcji montażu. Gwarancja nie uwzględnia wad i uszkodzeń spowodowanych niewłaściwym przygotowaniem do instalacji, użytkowaniem lub montażem.

Wszelkie parametry techniczne oraz atesty na tworzywa PolyForce® oraz ProFoam® dostępne są na stronie www.mardomdecor.com.

EN

Mardom Decor products can be installed outdoors and in rooms with high humidity. It is necessary to use Mardom Fix Extra adhesive then. When you install the mouldings outdoors, the products must be covered with exterior paint.

When you use LED lighting, we recommend to cover the mouldings with Mardom Decor Alu Tape for even better visual effect. The moulding covered with tape gives the effect of even illumination - without the transparency.

We recommend checking the product dimensions prior to installation, because the values given in the catalog may slightly differ from actual measurements.

In order to prevent issues with installation, products should be acclimated for 24-48 hours in the room in which they will be installed.

GUARANTEE

Mardom Decor products are covered by a 12 month warranty, provided that the customer uses the adhesives suggested by Mardom Sp. z o.o. and all the conditions relating to the installation instructions are met. The warranty does not cover defects and damage resulting from improper preparation for installation, improper use or improper installation.

All the technical parameters and certificates for the PolyForce® and ProFoam® materials are available on the www.mardomdecor.com website.

DE

Die Produkte von Mardom Decor können im Außenbereich und in Räumen mit erhöhter Luftfeuchtigkeit angebracht werden. Die Verwendung von Mardom Fix Extra Kleber ist hierfür erforderlich. Bei der Verwendung im Außenbereich müssen die Produkte mit einer Außenlackierung versehen werden.

Bei der Verwendung von LED-Beleuchtung empfehlen wir, die Innenseite der Leisten mit Mardom Decor Alu Tape zu bekleben, um einen optimalen Abstrahlwinkel zu erzielen.

Wir empfehlen, die Abmessungen der Produkte vor der Installation zu überprüfen, da die im Katalog angegebenen Werte geringfügig abweichen können.

Um Probleme bei der Installation zu vermeiden, müssen die Produkte für 24-48 Stunden in einem Raum offen lagern, bevor sie verbaut werden.

GARANTIE

Für Mardom Decor-Produkte ist eine 12-Monate-Garantie vorausgesetzt, sofern die von der Firma Mardom Sp. z o.o. vorgeschlagenen Klebstoffe verwendet und alle Bedingungen für Installationsanweisungen erfüllt werden. Die Garantie umfasst nicht Mängel und Schäden, die durch unsachgemäße Vorbereitung für die Installation, Verwendung oder Montage verursacht werden.

Alle technischen Spezifikationen und Freigaben von ProFoam®-PolyForce®-Kunststoffen sind auf der Seite www.mardomdecor.com verfügbar.

FR

Les produits Mardom Decor peuvent être installés en extérieur et dans des pièces humides. Il est alors nécessaire d'utiliser la colle Mardom Fix Extra. Pour une installation extérieure, les produits doivent être recouverts d'une peinture adaptée.

Lorsque vous utilisez un éclairage LED, nous vous recommandons d'appliquer un ruban Aluminium Mardom Decor coté intérieur des moulures pour un effet visuel encore meilleur. Une moulure recouverte de ruban à pour avantage d'uniformiser l'éclairage - sans pénétration de point de lumière.

Nous vous recommandons de vérifier les dimensions des produits avant le montage, car les valeurs données dans le catalogue peuvent légèrement varier.

Pour éviter les problèmes d'installation, stockez les produits à température ambiante pendant 24 à 48 heures dans la pièce de destination.

GARANTIE

Les produits Mardom Decor bénéficient d'une garantie de 12 mois à condition que les adhésifs recommandés par Mardom Sp. z o.o. soient utilisés et que toutes les conditions des notices de montage soient remplies. La garantie ne couvre pas les défauts ou les dommages causés par une préparation inadéquate de l'installation, par une utilisation ou un montage non conformes.

Tous les paramètres techniques et les homologations de PolyForce® et ProFoam® sont disponibles sur www.mardomdecor.com.

B

B2002	066
B2003	066
B2004	066
B2021	066
B3002	064
B3014	064
B3015	066
B3020	065
B3021	064
B3023	065
B3025	004, 065
B3029	064
B3030	064
B3033	064
B3038	065
B3047	065
B3050	066
B3077	066
B3110	064

C

C1000-1H	071, 073
C1000-1W	067, 069
C1000-2H	071, 073
C1000-2W	067, 069
C1001-1H	071, 073
C1001-1W	067, 069
C1001-2H	071, 073
C1001-2W	067, 069
C1002-1H	071, 074
C1002-1W	067, 070
C1002-2H	071, 074
C1002-2W	067, 070
C3000H	072, 073
C3000W	068, 069
C3001H	072, 073
C3001W	068, 069
C3002H	072, 074
C3002W	068, 070
C4000H	072, 073
C4000W	068, 069
C4001H	072, 073
C4001W	068, 069
C4002H	072, 074

C4002W	068, 070
C5000-4H	071, 073
C5000-4W	067, 069
C5001-4H	072, 073
C5001-4W	068, 069
C5002-4H	072, 074
C5002-4W	068, 070
C8031	084
C8032	084
C8035	084

D

D1500	078
D1501	078, 080
D1504	079, 081, 085
D1511	023, 078, 080, 081, 085, 088
D1515	079, 081
D1516	079, 080
D1518	079, 080
D1523	077, 079
D1541	037, 078, 080
D2512	083, 085
D2531	083, 085
D3003	077, 080, 081
D3007	076, 081
D3008	075, 081
D3010	077, 081
D3011	077, 080
D3012	077, 080
D3016	075, 080, 081
D3017	076, 080
D3023	075, 080
D3024	076, 080
D3502	075, 080
D3503	076, 080, 081
D3505	076, 080
D3509	077, 080
D3514	083, 085
D3515	083, 085
D3516	083, 085
D3517	083, 085
D3518	083, 085
D3519	076, 080, 085
D3533	076, 080

D3542	075, 080, 081, 085
D3543	075, 080, 081, 085
D3544	076, 080
D5002	075
D5003	077, 081

MD

MD001	026
MD001P	026
MD002	031, 035, 050, 082
MD003	018, 031, 032, 034
MD004	026
MD004P	026
MD005	029
MD005P	029
MD006	029
MD006P	029
MD007	036
MD008	027
MD008E	086
MD008P	027
MD009	028, 039, 042
MD009E	087
MD009P	028
MD010	034
MD011	026
MD011P	026
MD012	034
MD013	028
MD013P	028
MD014	027
MD014P	027
MD016	015, 028, 038, 057
MD016P	028
MD017	026
MD017P	026
MD018	027
MD018P	027
MD020	023, 030
MD020P	030
MD024	027, 037, 057
MD024P	027
MD025	029, 038, 054, 058
MD025P	029

MD026	035
MD094	004, 028, 039
MD094E	086
MD094P	028
MD095	018, 030
MD095P	030
MD105	058
MD118	056
MD234	026, 050
MD234P	026
MD235	026
MD235P	026
MD236	028
MD236P	028
MD237	039
MD255	035, 042
MD258	027
MD258E	086
MD258P	027
MD317	036
MD325	031, 032, 035
MD354	029
MD354P	029
MD355	028
MD355P	028
MD356	029, 032
MD356P	029
MD356E	087
MD358	029, 082
MD358P	029
MD359	026, 086
MD359E	086
MD359P	026
MD360	030, 031, 088
MD360P	030
MD361	030
MD361P	030
MD362	057
MD363	029
MD363P	029
MD367	046, 056
MD368	045, 056
MD369	057
MD413	034
MD8300	027
MD8300P	027

SPIS PRODUKTÓW

TABLE OF PRODUCTS | PRODUKTLISTE | LISTE DE PRODUITS

MDA

MDA002	051
MDA040	049
MDA005	051
MDA007	041, 051
MDA008	051
MDA040	051
MDA046	052
MDA067	052
MDA072	052, 060
MDA098	052
MDA106	051
MDA109	053
MDA113	053
MDA121	051
MDA138	052
MDA212	051
MDA218	052
MDA401	052

MDB

MDB001	046
MDB063	044
MDB064	046
MDB070	056
MDB080	057
MDB064	046
MDB100	057
MDB101	058
MDB102	046
MDB103	049
MDB104	049
MDB105	048
MDB106	045
MDB108	048
MDB110	047, 050
MDB111	047
MDB112	044
MDB115	058
MDB117	032, 047
MDB118	047
MDB121	048
MDB123	039

MDB127	045
MDB128	049
MDB130	044
MDB131	047
MDB132	045
MDB134	046
MDB135	023, 044
MDB136	044
MDB137	047, 031
MDB140	049
MDB142	047
MDB145	045
MDB147	045
MDB150	054, 059
MDB152	046
MDB154	048
MDB155	049
MDB156	048
MDB158	042, 048
MDB161	041, 047
MDB167	045
MDB169	004, 048
MDB172	044
MDB174	045
MDB180	032, 044
MDB185	046
MDB210	044
MDB213	046
MDB214	048

MDC

MDC217	040, 041
MDC236	040, 041
MDC239	040, 041
MDC250	040, 062, 063
MDC250-11	063
MDC250-12	062
MDC252	023, 040, 041, 063
MDC252-11	023, 063
MDC255	040
MDC258	040, 041, 062, 063
MDC258-12	062
MDC258-13	063

MDD

MDD305	037
MDD308	036, 062, 063
MDD308-11	063
MDD308-12	062
MDD311	037
MDD312	023, 034
MDD314	036, 039, 088
MDD315	039
MDD316	034
MDD318	035, 062
MDD318-12	062
MDD325	035, 062
MDD325-12	062
MDD332	004, 035, 062, 063
MDD332-11	063
MDD332-12	063
MDD332-13	062
MDD334	038
MDD335	039
MDD338	023, 037
MDD339	037
MDD345	038, 039
MDD346	032, 036, 088
MDD351	037
MDD356	038
MDD410	038
MDD412	036, 078, 081
MDD413	034, 088
MDD414	036

QL

QL001	059
QL002	057
QL006	036, 056
QL007	027, 056
QL007P	027
QL009	058
QL010	058
QL011	022, 058
QL016	023
QL017	038, 056
QL019	027, 028, 037, 054, 056, 057

QL019P	027, 028
QL021	026, 028, 054, 056
QL021P	026, 028
QL022	015, 034
QL023	014, 015, 035, 054
QL026	022
QL036	022
QL046	022
QL056	023
QL066	022
QL076	022
QL086	022
QL116	018, 022
QR001	065
QR002	054, 065
QR005	065
QS003	030
QS003P	030
QS004	029
QS004P	029
QS009	028
QS009P	028
QS011	024, 030, 038, 058
QS011P	030



MARDOM DECOR

Ratajska 11a

91-231 Łódź

Poland

tel. +48 42 678 67 86

www.mardomdecor.com

www.mardom-sp.pl

mardomdecor@mardom-sp.pl



Mardom Decor

MARDOM
DECOR