

2020

Light is life.

2021

GRINK

2020

Grok

2021

(EN) At Grok we aim to design a range of contemporary lighting products that are attractive and unconventional.

We understand that light has the capacity to affect our physical and emotional comfort, so it is essential to offer pieces to suit each space, activity and type of person.

At this point, we get involved in the entire creative process of our designers, adding value to their work as a way to achieving functional pieces that allow architects and interior designers to create unique atmospheres.

-

(ES) En Grok apostamos por diseñar una línea de producto de iluminación contemporáneo, con un diseño atractivo y sin convencionalismos.

Entendemos que la luz tiene la capacidad de actuar sobre nuestro confort físico y emocional, por lo que es primordial ofrecer piezas adecuadas a cada espacio, a cada actividad y a cada tipo de persona.

Para conseguirlo nos involucramos en todo el proceso creativo de nuestros diseñadores poniendo en valor su trabajo y, consiguiendo así, piezas funcionales que permitan a arquitectos e interioristas crear atmosferas únicas.

-

(FR) Chez Grok, nous misons sur la création d'une ligne de produits d'éclairage contemporains au design attrayant dénué de conventionnalismes.

Conscients que la lumière a la capacité d'agir sur notre confort physique et émotionnel, il nous semble primordial d'offrir des modèles adaptés à chaque espace, à chaque activité et à chaque genre de personne.

C'est pour cela que nous nous impliquons dans tout le processus créatif de nos designers en mettant en valeur leur travail, de manière à obtenir des pièces fonctionnelles qui permettent aux architectes et aux décorateurs de créer des ambiances uniques.

-



(EN) Grok pieces are sculptures that stand out for their simplicity: each piece is a quest for substance and style.

(ES) Grok son piezas escultóricas que priman por su simplicidad: cada pieza es una búsqueda de lo esencial.

(FR) Grok, ce sont des pièces sculpturales qui privilégient la simplicité : chaque pièce est une quête de l'essentiel.

PURE SPACE, PURE SHAPES
 GEOMETRÍA PURA EN EL ESPACIO
 GÉOMÉTRIE PURE DANS L'ESPACE



CUSTOMIZATION AND
 MODULARITY
 CUSTOMIZACIÓN Y
 MODULARIDAD
 PERSONNALISATION ET
 MODULARITÉ



(EN) Our pieces are designed to provide flexibility and creative freedom.

(ES) Nuestras piezas están pensadas para dar flexibilidad y libertad de creación.

(FR) Nos modèles sont conçus pour offrir flexibilité et liberté de création.



EXPRESSION
THROUGH MATERIALS
EXPRESIÓN DE LOS
MATERIALES
EXPRESSION DES
MATÉRIAUX



(EN) Grok introduces a variety of natural, recycled and high-quality materials in its pieces, which give them both extra character and style.

(ES) Grok introduce en sus piezas distintos materiales naturales, reciclados y de alta calidad, que las dotan de carácter y sensibilidad.

(FR) Grok introduit dans ses pièces différents matériaux naturels, recyclés et de grande qualité, qui les dotent de caractère et de sensibilité.



TECHNOLOGY
TECNOLOGÍA
TECHNOLOGIE

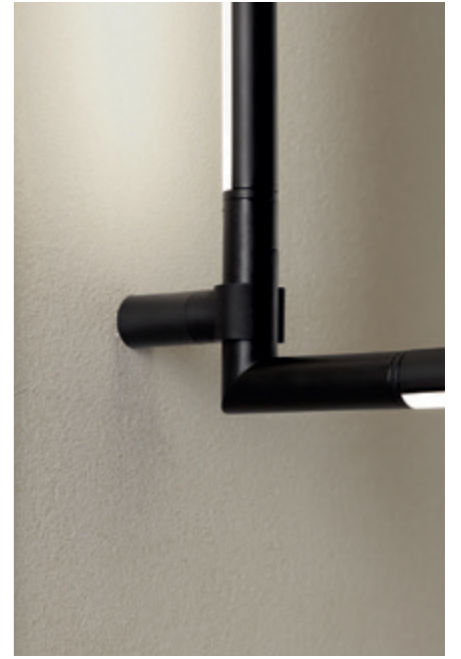

(EN) Minimum profile cross-sections, freedom of movement and user interactivity, connectivity and light control.

(ES) Mínima sección de los perfiles, libertad de movimientos e interacción con el usuario, conectividad y control de la luz.

(FR) Section de profilé minimale, liberté de mouvement et d'interaction avec l'utilisateur, connectivité et contrôle de la lumière.



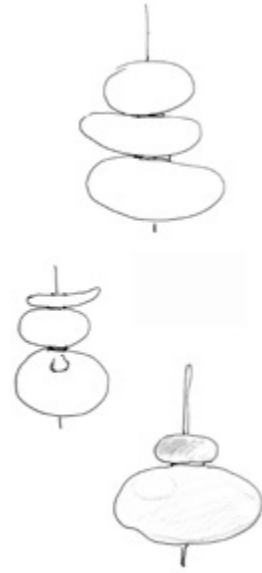

OUR DESIGNERS
NUESTROS DISEÑADORES
NOS DESIGNERS

[EN] Grok, as a brand, is constantly seeking out new designers who can bring fresh ideas and concepts to light and decorate a space. Our designers strive for maximum artistic appeal in the simplicity of objects, feeling without losing functionality and attention to detail. The result is products with a novel, high-tech and timeless character.

[ES] Grok es una marca que está constantemente en busca de nuevos diseñadores que puedan aportar nuevas ideas y conceptos sobre cómo iluminar y decorar un espacio. Nuestros diseñadores buscan la máxima expresión en la simplicidad de los objetos, la afectividad sin perder la funcionalidad y el cuidado hasta el detalle. El resultado son productos de carácter novedoso, tecnológico y atemporal.

[FR] Grok est une marque qui est constamment à la recherche de nouveaux designers capables d'apporter des idées et concepts nouveaux sur la façon d'illuminer et de décorer un espace. Nos designers recherchent l'expression maximale dans la simplicité des objets, l'affectivité sans perdre la fonctionnalité, ainsi que le souci du détail. Cela donne des produits au caractère innovant, technologique et intemporel.

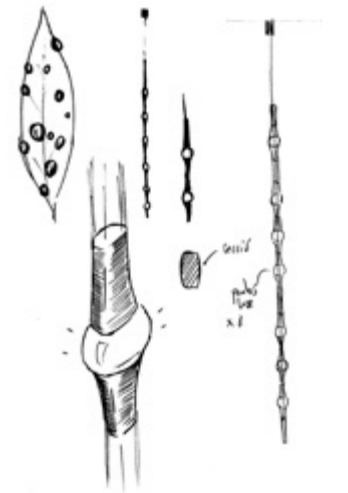
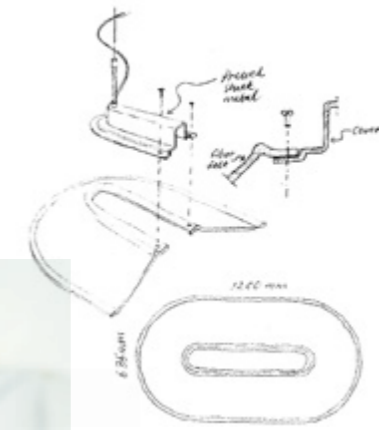

JOEL KARLSSON, KROOK &
TJÄDER DESIGN

Gothenburg



NAHTRANG DISSENY

Barcelona



YONOH

Valencia





LUCA
TURRINI
Imola



FRANCESC
VILARÓ
Barcelona

IRATZOKI
LIZASO
French Basque Country



CÉLINE
WRIGHT
Paris



BENEDITO DESIGN

Barcelona



JORDI LLOPIS

Barcelona



JOSEP PATSÍ

Barcelona



WIS DESIGN

Stockholm



INDEX ÍNDICE INDICE

1. MODULAR MODULAR MODULAR

TUBS MODULAR
26



2. PENDANT SUSPENSIÓN SUSPENSION

CIRCULAR
40

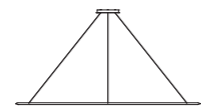

CANDLE
50



DEW
60



SHOEMAKER
64

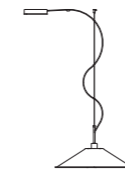

VOILES
70



INVISIBLE
78



ILARGI
82

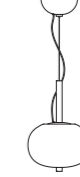

CATENARIA
86

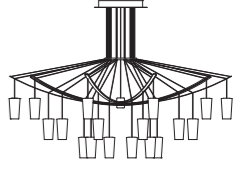

TUBS
90

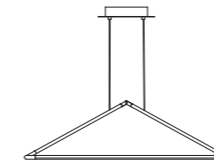

ALIVE
94



SATURN
98

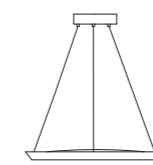

UMBRELLA
100

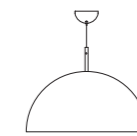

HELLO
102

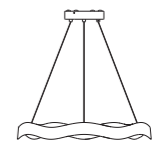

RINGOFIRE
104



CIRC
106

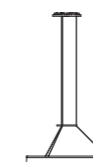

NET
108



3. WALL PARED MURAL

TUBS
112

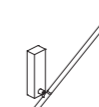

ELY
116

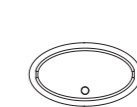

VOILES
122

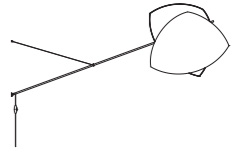

INVISIBLE
126



BIG BANG
130

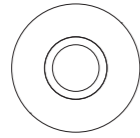

HALL
132

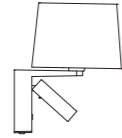

BEND
134



PRIME
136



SKATA
138



FLAVIA
140

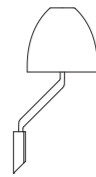

4. TABLE
SOBREMESA
TABLE

TUBS
144



COCKTAIL
148

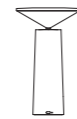

ILARGI
154

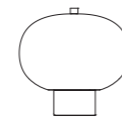

INVISIBLE
156

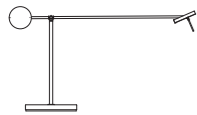

HALL
158

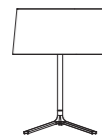

PREMIUM
160

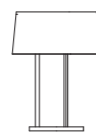

5. FLOOR
PIE
PIED

TUBS
164



INVISIBLE
168



CIRC
172



HALL
174



PREMIUM
176



FLAVIA
178



COLLECTIONS INDEX

ÍNDICE DE COLECCIONES

INDEX DES COLLECTIONS

ALIVE

94



BEND

134

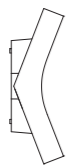

BIG BANG

130

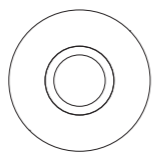

CANDLE

57



58



52



CATENARIA

89



86

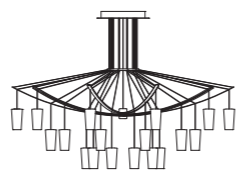

53



54

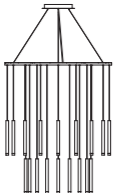

50



CIRC

106

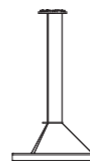

106

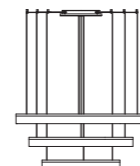

172



CIRCULAR

40

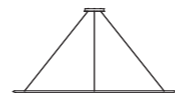

40

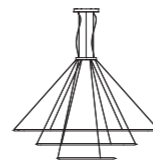

40

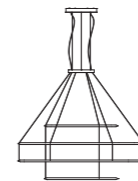

44

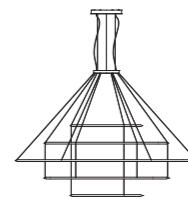

49



COCKTAIL

148

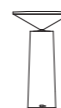

DEW

60



60

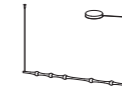

ELY

116

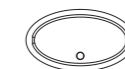

FLAVIA

140

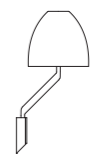

178



HALL

132

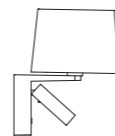

158



174



HELLO

102

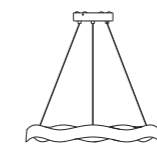

ILARGI

85 82 154

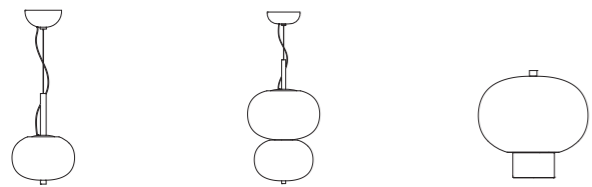

INVISIBLE

80 80 78

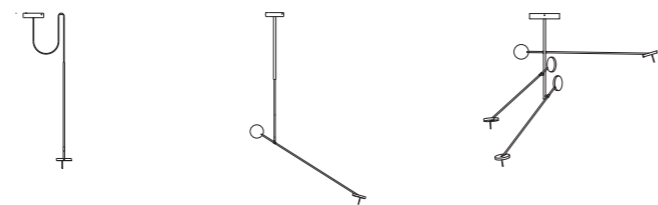

TUBS

90 112 144 164



INVISIBLE

126 128 156 168

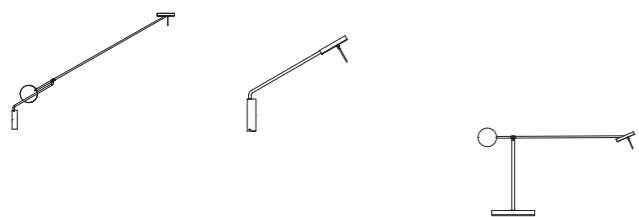

NET

108



TUBS MODULAR

26 26 29 35 33 30

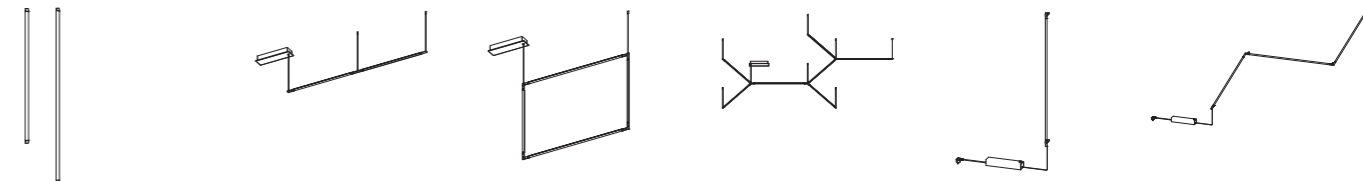

PREMIUM

160 176

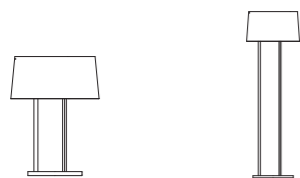

PRIME

136

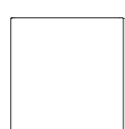

RINGOFIRE

104



SATURN

98

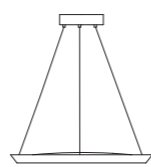

UMBRELLA

100

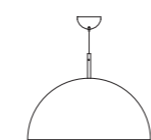

VOILES

74 70 122

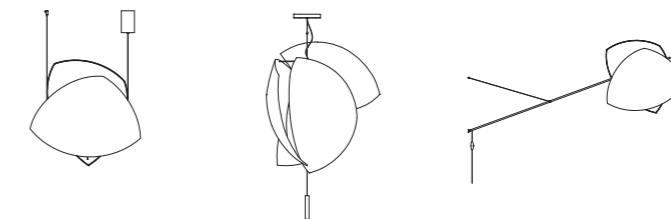

SHOEMAKER

68 64

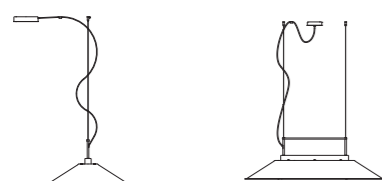

SKATA

138

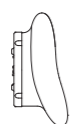

1.

MODULAR
MODULAR
MODULAIRE

TUBS MODULAR

by Nahtrang Disseny

(EN) Tubs Modular seeks ways to structure open spaces spatially, to create lattice shapes with air and light, and linear shapes that enhance the roominess of a space. A very visually appealing family, it plays with the lines within a space. As the piece takes shape, it becomes a living element capable of infinite expansion, but also be designed in smaller versions and adapted to smaller spaces. Tubs Modular is a highly flexible and technically sophisticated family of products, ensuring maximum user control within a slim profile.

(ES) Tubs Modular busca una manera de estructurar el vacío de un espacio, de crear formas reticulares con el aire y la luz y generar formas lineales que potencian esa sensación de amplitud. Una familia muy poética visualmente, que juega con los planos del espacio. A medida que se da forma a la pieza, se va convirtiendo en un elemento vivo que se puede aumentar infinitamente, pero que también se puede construir en versiones más pequeñas y adaptar a espacios más reducidos. Tubs Modular es una familia técnicamente sofisticada y muy flexible, permitiendo el máximo control del usuario en una mínima sección del perfil.

(FR) Tubs Modular cherche un moyen de structurer le vide d'un espace, de relier l'air et la lumière et de générer des formes linéaires qui renforcent cette sensation d'ampleur. Une famille visuellement très poétique, qui joue sur les plans de l'espace. À mesure que la pièce prend forme, elle devient un élément vivant qui peut croître à l'infini mais qui peut aussi être construit en version réduite et épouser des espaces plus limités. Tubs Modular se présente comme une famille techniquement sophistiquée et très flexible, qui permet un contrôle maximum de l'utilisateur dans une section minimale de profilé.

* Technical information pg. 213

* Información técnica pág. 213

* Information technique page 213

—
MODULARITY
MODULARIDAD
MODULARITÉ





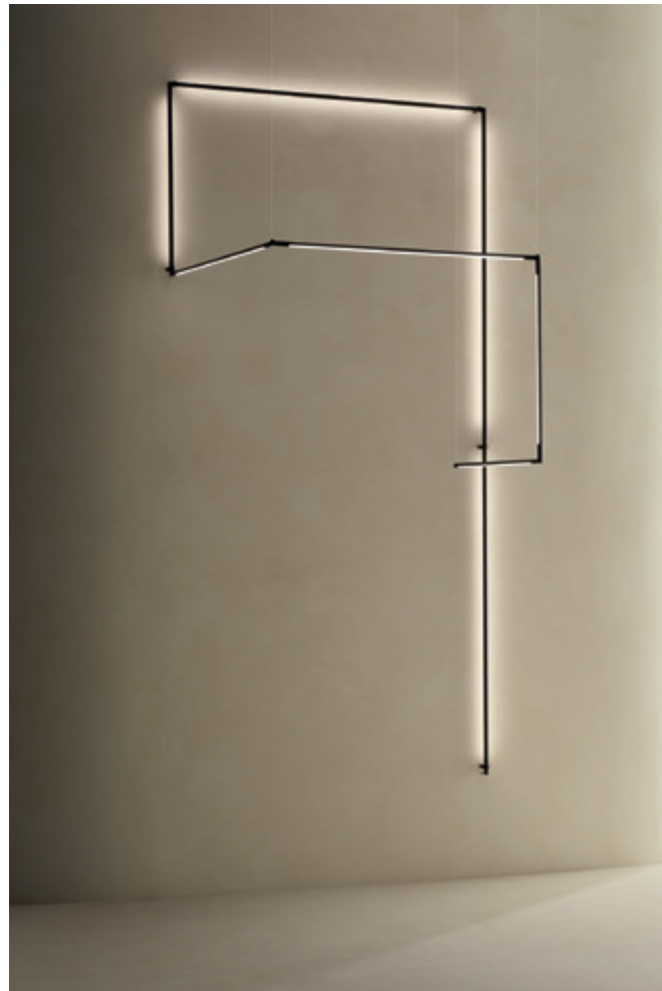

COMPONENTS OF TUBS MODULAR - COMPONENTES DE TUBS MODULAR - COMPOSANTS DE TUBS MODULAR

For further details, please consult the technical data sheets or our sales department. | Para más detalles, consultar las fichas técnicas o nuestro departamento comercial. | Pour en savoir plus, consulter les fiches techniques ou le service commercial.

LIGHT BULBS | TUBOS DE LUZ | TUBES LUMINEUX

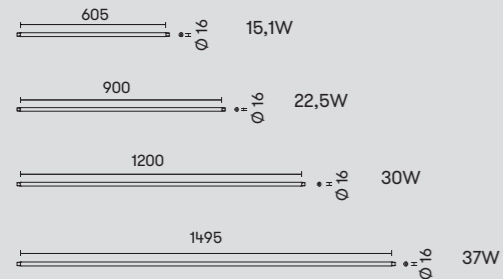

CONNECTORS | CONECTORES | CONNECTEURS

- Current and continuity input Y connector
Conector Y de entrada de corriente y de continuidad
Connecteur Y d'entrée de courant et de continuité
- Linear current and continuity input connector
Conector lineal de entrada de corriente y de continuidad
Connecteur linéaire d'entrée de courant et de continuité
- 120° current and continuity input connector
Conector 120° de entrada de corriente y de continuidad
Connecteur 120° d'entrée de courant et de continuité
- 90° horizontal current and continuity input connector
Conector 90° horizontal de entrada de corriente y de continuidad
Connecteur 90° horizontal d'entrée de courant et de continuité
- 90° vertical current and continuity input connector
Conector 90° vertical de entrada de corriente y de continuidad
Connecteur 90° vertical d'entrée de courant et de continuité
- 90° connector without wire
Conector 90° sin cable
Connecteur 90° sans câble

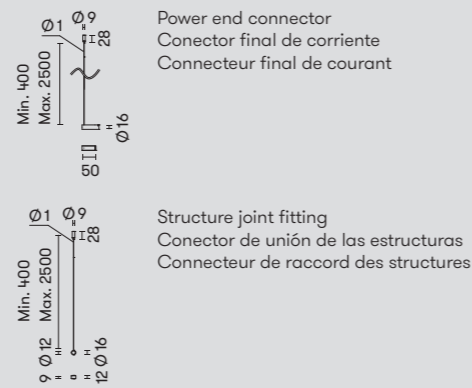

BULB BASE | FLORÓN | BASE D'ALIMENTATION

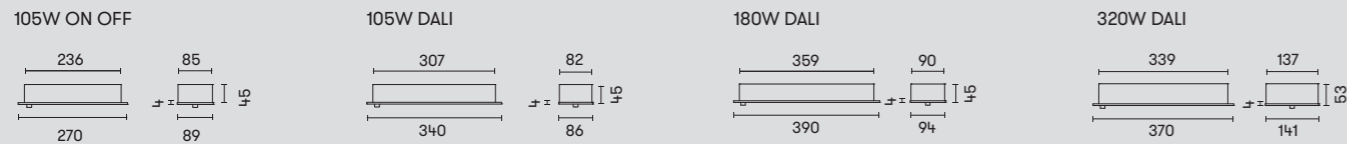

WALL ATTACHMENT CLIP FOR WALL AND CEILING | CLIP DE FIJACIÓN PARA PARED Y TECHO | CLIP DE FIXATION MURALE ET PLAFOND

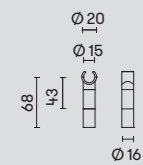

POWER SUPPLY UNIT WITH SOCKET | CAJA DE ALIMENTACIÓN CON TOMA DE CORRIENTE | BOÎTIER D'ALIMENTATION AVEC PRISE DE COURANT







2.

PENDANT
 SUSPENSIÓN
 SUSPENSION

CIRCULAR	TUBS
40	90
CANDLE	ALIVE
50	94
DEW	SATURN
60	98
SHOEMAKER	UMBRELLA
64	100
VOILES	HELLO
70	102
INVISIBLE	RINGOFIRE
78	104
ILARGI	CIRC
82	106
CATENARIA	NET
86	108

CIRCULAR

by *Benedito Design*

(EN) Circular combines design and architecture to create lighting for spacious settings. A family of circular rings with a premium contemporary design that offers maximum versatility, blending formats, finishes and light directionality.

(ES) Circular es el resultado de unir diseño y arquitectura en la creación de luminarias para grandes espacios. Una familia de aros circulares con un diseño contemporáneo de alta calidad que ofrece la máxima versatilidad, combinando sus diferentes formatos, acabados y direcciones de luz.

(FR) Circulaire est le fruit du mariage entre design et architecture dans la création de luminaires destinés aux grands espaces. Une famille d'anneaux circulaires au style contemporain de grande qualité qui offre une polyvalence maximale en déclinant différents formats, finitions et directions de lumière.

* *Technical information pg. 188*

* *Información técnica pág. 188*

* *Information technique page 188*

—
 DIMENSIONAL STABILITY
 ESTABILIDAD DIMENSIONAL
 STABILITÉ DIMENSIONNELLE







COMBINATIONS - COMBINACIONES - COMBINAISONS

LIGHT DIRECTION | DIRECCIÓN DE LA LUZ | DIRECTION DE LA LUMIÈRE

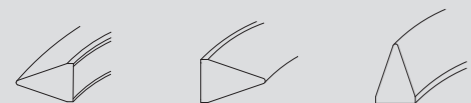

FINISHING | ACABADOS | FINITIONS



CEILING ROSE | TIPO FLORÓN | TYPE DE MONTURE

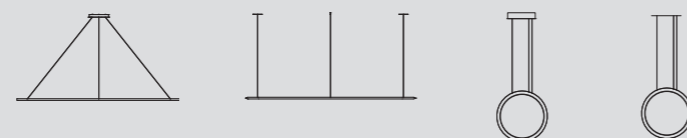

MODELS | MODELOS | MODÈLES

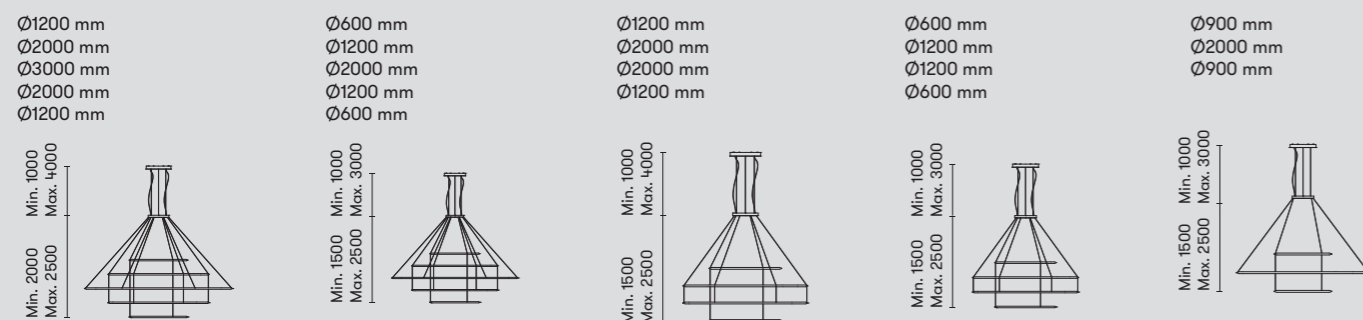
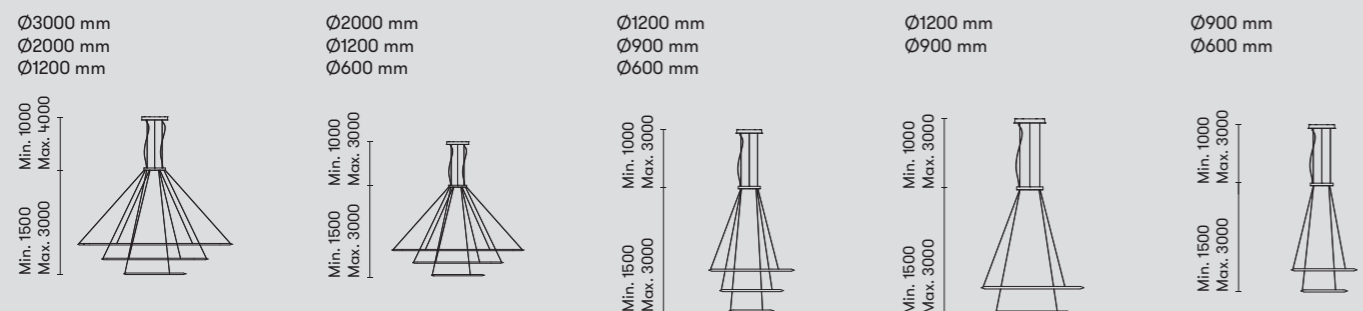
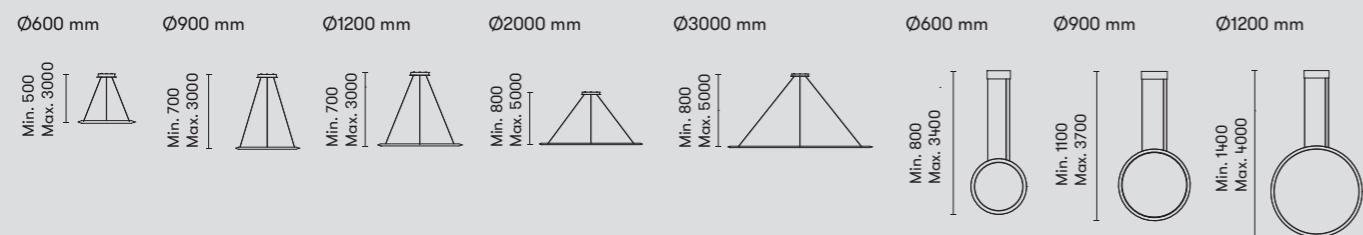

CHANDELIERS | CHANDELIERS | LUSTRES



(EN) The different number of structures, sizes and positions for Circular allows you to create interesting shadows with a sculptural and sophisticated effect.

(ES) Las diferentes combinaciones en número de estructuras, medidas y posiciones de Circular permiten crear interesantes siluetas con un toque escultórico y sofisticado.

(FR) Les nombreuses possibilités de structures, dimensions et positions de Circular permettent de créer des silhouettes intéressantes avec un touche sculpturale et sophistiquée.



CANDLE

by *Benedito Design*

(EN) Featuring a delicate, jewel-like design, this light fixture is a reinterpretation of a classic chandelier with an LED light source. Its light projection creates and accentuates the spaces where it hangs, achieving a warm, natural ambience. Candle comes to life as a comprehensive family of products that, from just one tubular element, provides a range of elements sculpted from different solutions.

(ES) Esta delicada luminaria, que se muestra como si de una joya se tratara, es la reinterpretación de un candelabro clásico con fuente de luz LED. La proyección de su luz crea y acentúa los espacios donde se ubica, consiguiendo atmósferas cálidas y naturales. Candle se presenta como una familia completa que, desde un único elemento tubular, introduce una serie de elementos escultóricos que originan diferentes soluciones.

(FR) Ce délicat luminaire, qui se présente comme un bijou, est la réinterprétation d'un lustre classique doté d'une source lumineuse LED. La projection de sa lumière crée et accentue les espaces où il se trouve, produisant ainsi des atmosphères chaudes et naturelles. Candle se présente comme une famille complète qui, à partir d'un seul élément tubulaire, introduit une série d'éléments sculpturaux offrant plusieurs solutions.

* *Technical information pg. 184*

* *Información técnica pág. 184*

* *Information technique page 184*

—
REINTERPRETING A CLASSIC
REINTERPRETACIÓN DE UN CLÁSICO
RÉINTERPRÉTATION D'UN CLASSIQUE

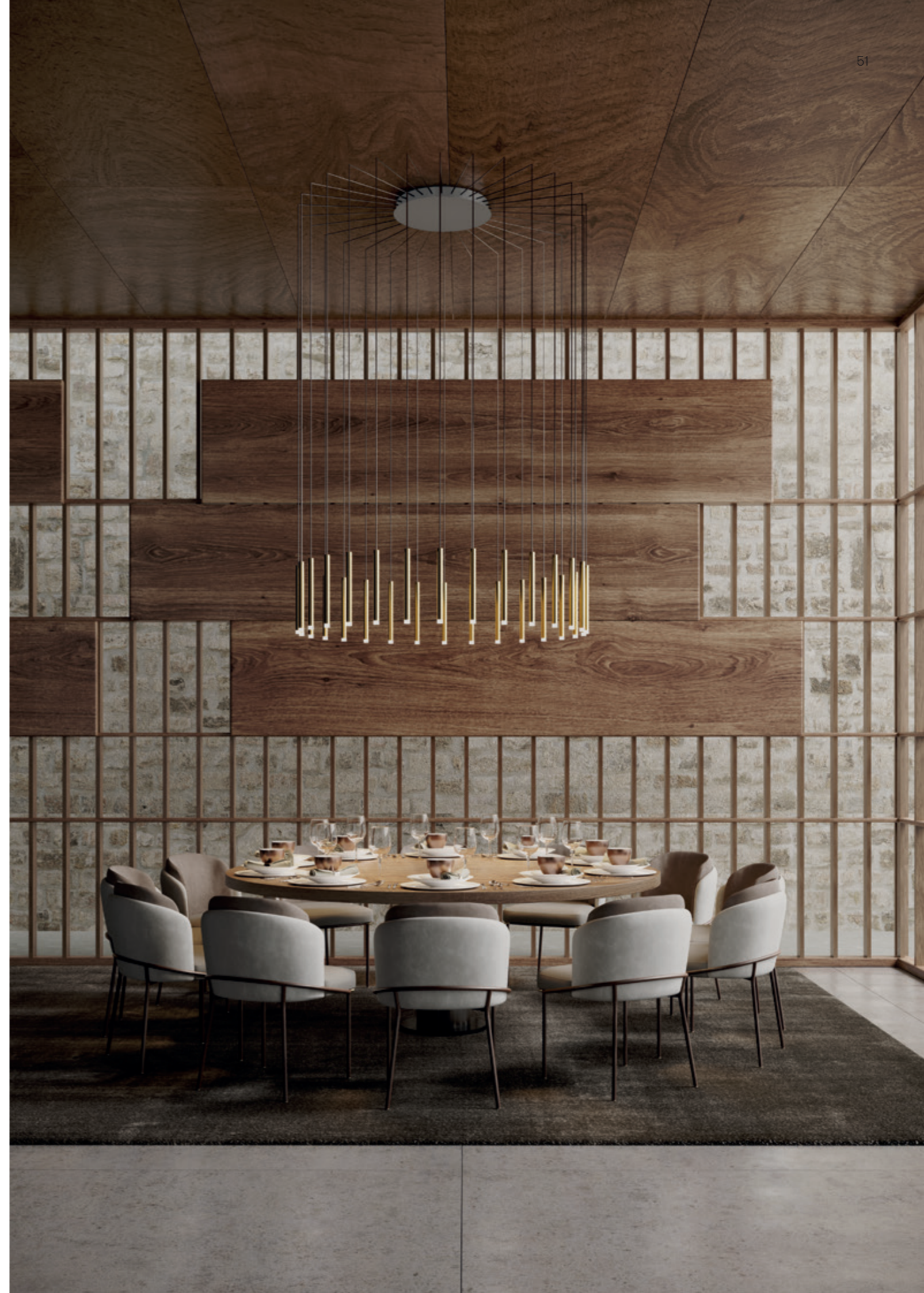





COMBINATIONS - COMBINACIONES - COMBINAISONS

FINISHING | ACABADOS | FINITIONS



MODELS | MODELOS | MODÈLES

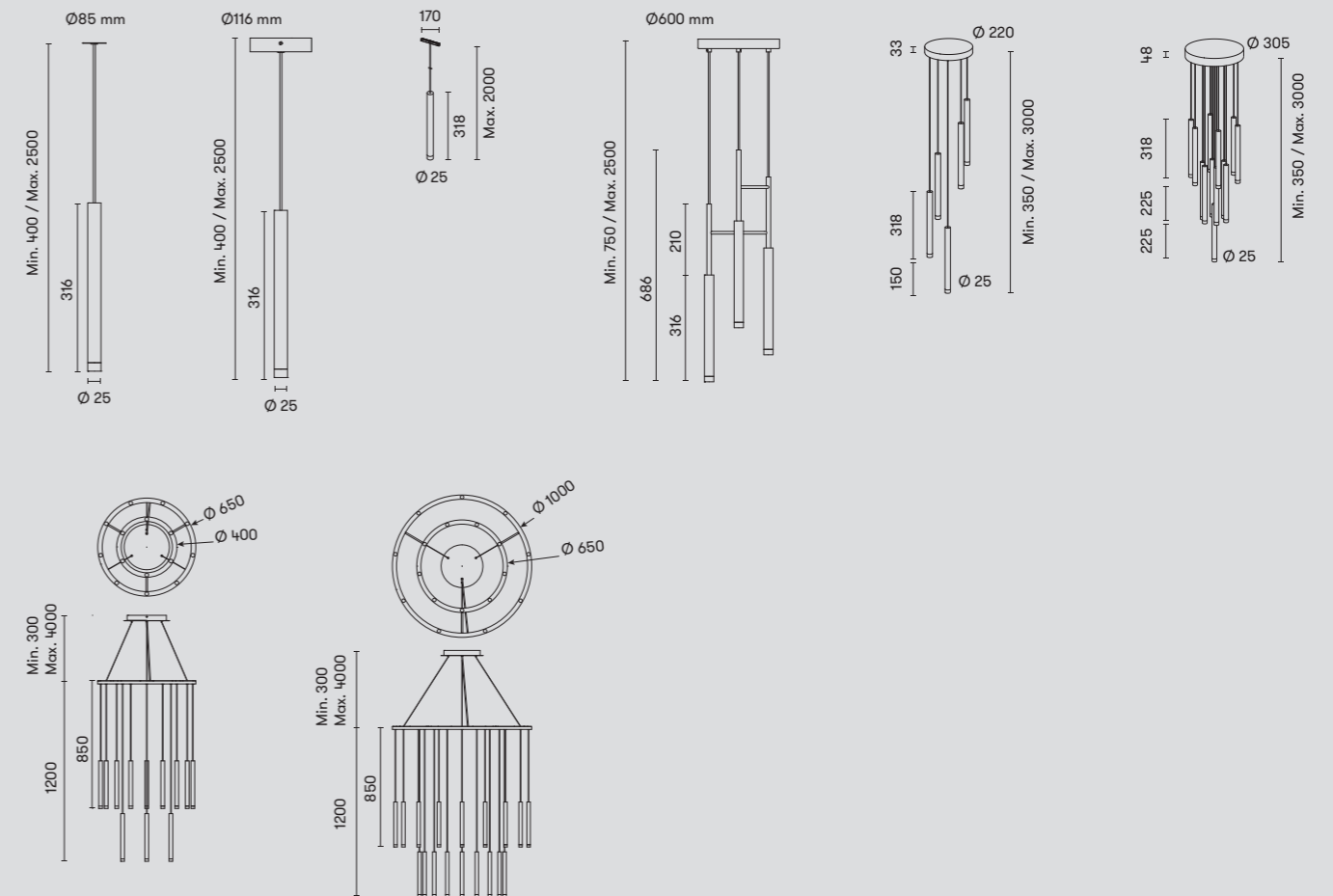

ACCESSORIES | ACCESORIOS | ACCESSOIRES



CHANDELIERS | CHANDELIERS | LUSTRES

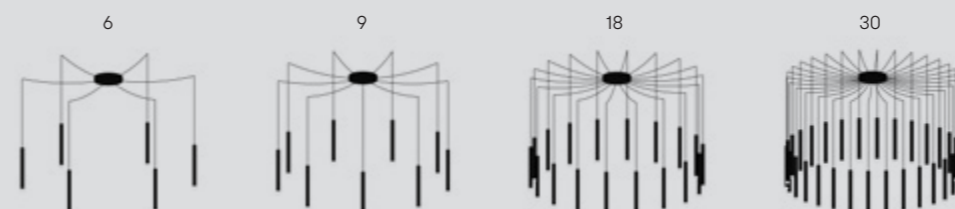





DEW

by Yonoh

(EN) Dew explores light and ephemeral beauty: like dewdrops or spring rain. An organic and linear configuration shaped by a line of oval points of light connected by aluminium pieces at varying distances. This lamp features robust technical features, but still exudes artistic flair. Dew comes in both vertical and horizontal variations, making any combination and angle a possibility. Due to its finesse and versatility, it suits any kind of space as a composite lamp for halls, stairwells, foyers, etc.

(ES) Dew explora la belleza de lo ligero y efímero: como las gotas del rocío o la lluvia intermitente en primavera. Una composición orgánica y longitudinal que se conforma a partir de una línea de puntos de luz ovalados unidos entre sí por piezas de aluminio a distintas distancias. Es una lámpara con fuerte carácter técnico, pero que no pierde su enfoque poético. Dew se presenta con sus versiones en vertical y en horizontal, permitiendo todas las combinaciones e inclinaciones posibles. Por su sutileza y versatilidad, encaja en cualquier tipo de espacio como lámpara compuesta para halls, huecos de escalera, recibidores, etc.

(FR) Dew explore la beauté de la lumière et de l'éphémère : comme les gouttes de rosée ou la pluie de printemps intermittente. Cette composition organique et longitudinale est constituée d'une ligne de points lumineux ovales reliés entre eux par des pièces d'aluminium situées à des distances différentes. C'est une lampe qui allie un côté technique marqué sans perdre son approche poétique. Dew se présente dans ses versions verticale et horizontale, permettant toutes les combinaisons et inclinaisons possibles. Grâce à sa subtilité et à sa polyvalence, ce modèle s'intègre dans toutes sortes d'espace, comme une lampe composite pour les halls, cages d'escalier, réceptions, etc.

* Technical information pg. 195

* Información técnica pág. 195

* Information technique page 195

—
A LIGHT TOUCH
LIGEREZA
LÉGÈRETÉ



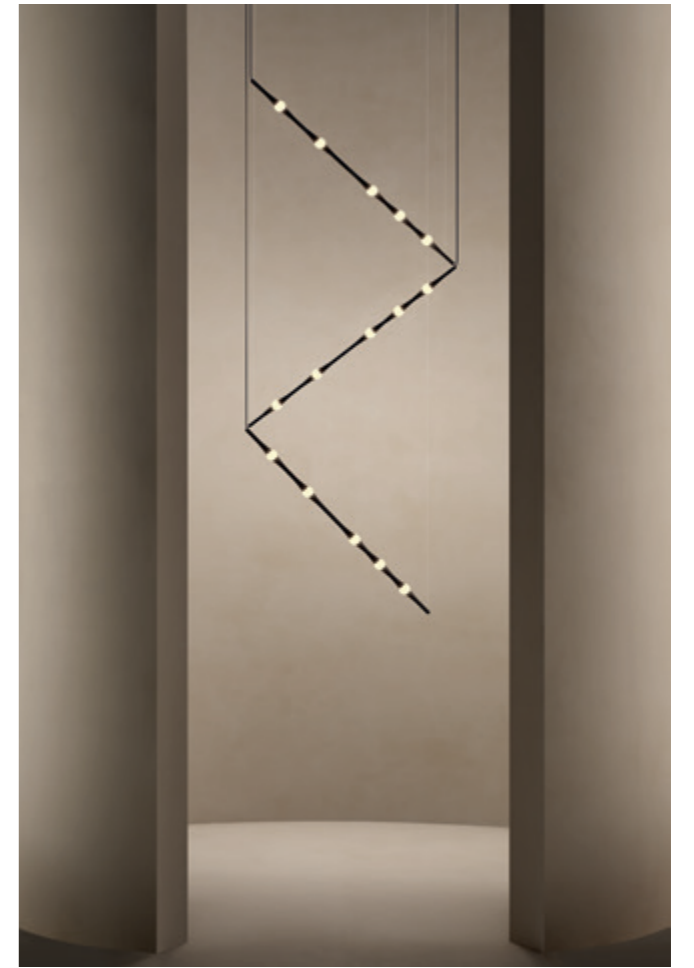

Dew comes in two sizes, 1,000 mm and 1,700 mm, in a painted black matte finish. | Dew viene en dos tamaños, de 1000 mm y 1700 mm, en acabado pintado de negro mate. | Dew existe en deux dimensions de 1 000 mm et 1 700 mm, dans une finition peinte en noir mat.

SHOEMAKER

by Joel Karlsson

(EN) Shoemaker redefines classic lighting, providing powerful technical features. The felt shade brings warmth and reduces noise in a space. The smart lighting LED technology enables temperature and light intensity control, offering maximum visual comfort. This is why Shoemaker is the ideal solution for restaurants, offices and soft contract projects alike.

(ES) Shoemaker reinterpreta un clásico de la iluminación, aportándole fuertes atributos técnicos. Su pantalla confeccionada en fieltro confiere al espacio calidez y capacidad de insonorización a la vez. La tecnología LED con smart lighting permite el control de la temperatura y la potencia de la luz con un elevado confort visual. Por esta razón, Shoemaker se presenta como la solución ideal para restaurantes, oficinas y proyectos de soft contract en general.

(FR) Shoemaker réinterprète un classique de l'éclairage en lui apportant de solides attributs techniques. Son abat-jour en feutre confère à l'espace chaleur et capacité d'insonorisation à la fois. La technologie LED à éclairage intelligent (Smart Lighting) permet de contrôler la température et la puissance de la lumière avec un grand confort visuel. C'est pourquoi Shoemaker est la solution idéale pour les restaurants, les bureaux et les projets de « soft contract » en général.

* Technical information pg. 209

* Información técnica pág. 209

* Information technique page 209

—
WARMTH
CALIDEZ
CHALEUR







Shoemaker comes in two finishes: grey and anthracite | Shoemaker viene en dos acabados: gris y antracita. | Shoemaker est disponible en deux coloris : gris et anthracite.



VOILES

by Céline Wright

(EN) Voiles pushes the envelope of contemporary design for large spaces with a style of sculpture far removed from conventional materials and shapes, opting for traditional craftsmanship.

On the one hand, its asymmetric shape provides a different vision depending on your position. On the other hand, the Japanese Washi paper gives the piece a lightness that allows constant movement.

Together they create a poetic living piece that makes any space more beautiful.

(ES) Voiles desafía el diseño contemporáneo de grandes espacios con una escultura que huye de las formas y materiales convencionales, y apuesta por el trabajo artesanal.

Por un lado, su forma asimétrica permite una visión distinta según el punto de mira. Y, por otra parte, el papel Washi japonés otorga a la pieza una ligereza que permite un constante movimiento.

Juntos crean una pieza poética viva que embellece cualquier espacio.

(FR) Voiles défie le design contemporain des grands espaces avec une sculpture qui fuit les formes et les matériaux conventionnels et mise sur le travail artisanal.

D'une part, sa forme asymétrique permet une vision différente en fonction du point de vue. D'autre part, le papier japonais Washi confère à la pièce une légèreté qui permet un mouvement constant.

Le tout crée une pièce poétique vivante qui embellit n'importe quel espace.

* Technical information pg. 218

* Información técnica pág. 218

* Information technique page 218

—
CRAFTSMANSHIP IN MOVEMENT
ARTESANÍA EN MOVIMIENTO
ARTISANAT EN MOUVEMENT









(EN) The versatility of its components allows different compositions.

(ES) La versatilidad de los elementos de Voiles permite realizar diferentes composiciones de la luminaria.

(FR) La grande polyvalence des éléments de Voiles permet de créer différentes compositions du luminaire.



INVISIBLE

by Francesc Vilaró

(EN) Invisible is intuition, functionality and beauty. A design based on the balance between these concepts, that transmits a feeling of weightlessness like a ceiling mobile. The different positions of its head and arm create multiple compositions that mean the light can be moulded and directed as you please, integrating it into the space.

Its beauty lies in its simplicity and makes it an iconic piece. In 2016, Invisible by Francesc Vilaró was awarded the German Design Award.

(ES) Invisible es intuición, funcionalidad y ligereza. Un diseño basado en el equilibrio de estos conceptos que transmite una percepción de ingravidez que nos recuerda a un móvil. Las diferentes posiciones de su cabezal y su brazo generan múltiples composiciones que permiten moldear y direccionar la luz donde deseemos, integrándola en el espacio.

En su simplicidad radica su belleza y la convierte en un elemento icónico. En 2016, Invisible de Francesc Vilaró fue galardonada con el German Design Award.

(FR) Invisible est synonyme d'intuition, de fonctionnalité et de légèreté. Sa ligne repose sur l'équilibre de ces concepts et transmet une perception d'apesanteur qui évoque un mobile. Les différentes positions de sa tête et de son bras génèrent de nombreuses compositions qui permettent de moduler et de diriger la lumière là où on le désire, l'intégrant ainsi dans l'espace.

La beauté de ce modèle réside dans sa simplicité pour en faire un élément emblématique. En 2016, Invisible de Francesc Vilaró a reçu le German Design Award.

* Technical information pg. 203

* Información técnica pág. 203

* Information technique page 203

—
SIMPLICITY AND BALANCE
SIMPLICIDAD Y EQUILIBRIO
SIMPLICITÉ ET ÉQUILIBRE





The rotating head means the light can be directed. | La rotación del cabezal permite dirigir la luz. | La rotation de la tête permet de diriger la lumière.



ILARGI

by Iratzoki Lizaso

(EN) Ilargi, designed by Basque studio Iratzoki Lizaso, takes shape in a subtle and minimalist piece where a wooden wand sits between traditionally hand-blown glass spheres.

Its warm, timeless design provides soft, pleasant light that adapts to professional and domestic settings, creating comfortable, natural spaces.

(ES) Ilargi, diseñada por el estudio vasco Iratzoki Lizaso, se materializa en una intervención sutil y mínima en la que una vara de madera se introduce en unas esferas de vidrio soplado hechas a mano de manera tradicional.

Su diseño afectivo y atemporal consigue una luz suave y agradable que se adapta tanto a espacios profesionales como domésticos. Creando ambientes confortables y naturales.

(FR) Créé par le studio basque Iratzoki Lizaso, Ilargi arbore une tige en bois subtilement introduite dans des boules en verre soufflé faites à la main de façon traditionnelle.

Sa ligne affective et intemporelle assure une lumière douce et agréable qui s'adapte aussi bien aux espaces professionnels que domestiques. Le tout pour créer des décors confortables et naturels.

* Technical information pg. 202

* Información técnica pág. 202

* Information technique page 202

—
TIMELESS SOFTNESS
SUAVIDAD ATEMPORAL
DOUCEUR INTEMPORELLE





(EN) Ilargi is available in three models: single suspension, double suspension and desk top, with natural wood finishes and in black.

(ES) Ilargi está disponible en tres modelos: suspensión simple y doble y sobremesa con acabados de madera natural y en negro.

(FR) Ilargi est disponible en trois modèles : suspension simple, suspension double et lampe à poser avec finitions bois naturel et noir.



CATENARIA

by Francesc Vilaró

(EN) Francesc Vilaró was inspired by Gaudí's catenary arches to create a piece with large dimensions where the alabaster and its warm, intimate light stand out.

The chrome structure with a 1.7 m diameter, composed of 30 alabaster tulips and a central black marble counterweight create a classic chandelier with a contemporary style.

(ES) Francesc Vilaró se inspira en los arcos catenarios de Gaudí para crear una pieza de grandes dimensiones donde los protagonistas son el alabastro y su luz cálida e intimista.

La estructura cromada de 1,7 m de diámetro, compuesta por 30 tulipas de alabastro y un contrapeso central en mármol negro, conforman un chandelier clásico de estilo contemporáneo.

(FR) Francesc Vilaró s'inspire des arcs caténares de Gaudí pour créer une pièce de grandes dimensions qui fait la part belle à l'albâtre et à sa lumière chaude et intimiste.

Sa structure chromée de 1,7 m de diamètre, composée de 30 tulipes en albâtre et d'un contrepoids central en marbre noir, forme un lustre classique de style contemporain.

* Technical information pg. 185

* Información técnica pág. 185

* Information technique page 185

—
INTIMATE CHANDELIER
CHANDELIER INTIMISTA
CHANDELIER INTIMISTE





Simple version. | Versión simple. | Version simple.



TUBS

by Nahtrang Disseny

(EN) With its unique design, the geometry of its pyramid-shaped lines trap the light inside, delicately highlighting and creating order wherever it is used. Its soft but powerful light makes it the perfect versatile accompaniment for large spaces.

(ES) De diseño único, su juego geométrico de líneas piramidales atrapa la luz en su interior marcando y ordenando con delicadeza los espacios donde se instala. Su tenue pero potente luz la presenta como una pieza versátil ideal para grandes espacios.

(FR) Avec un design unique, son jeu géométrique de lignes pyramidales capte la lumière à l'intérieur pour marquer et ajuster délicatement les espaces où elle est installée. Sa ténue, mais puissante lumière la présente comme une pièce polyvalente idéale pour les grands espaces.

* Technical information pg. 211

* Información técnica pág. 211

* Information technique page 211

Pendant | Suspensión | Suspension



—
BALANCE
EQUILIBRIO
ÉQUILIBRE



ALIVE

by Francesc Vilaró

(EN) Its timeless design is based on the bare minimum required for illumination; the light source. Its multiple configurations allow various lighting needs to be personalised and resolved. The high-quality frosted glass lampshade offers a silky, diffuse and warm light.

(ES) Su diseño atemporal se basa en el elemento mínimo, la fuente de luz. Sus múltiples configuraciones ofrecen diferentes soluciones. El cristal matizado de alta calidad de la pantalla, soplado a mano, ofrece una luz sedosa, difusa y cálida. Disponible en dos acabados, cromado y negro, con un cable realmente fino y tornillos invisibles.

(FR) Son design intemporel est basé sur l'élément minimal nécessaire pour éclairer : la source de lumière. Ses multiples configurations permettent de personnaliser et de fournir des solutions aux différents besoins d'éclairage. L'écran en verre trempé de grande qualité offre une lumière soyeuse, chaude et diffuse.

* Technical information pg. 182

* Información técnica pág. 182

* Information technique page 182

—
CLARITY
CLARIDAD
CLARTÉ

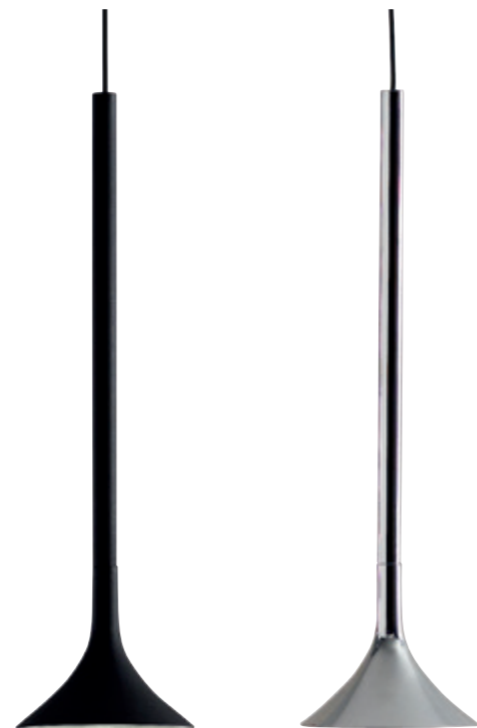



SATURN

by Benedito Design

Pendant | Suspensión | Suspension



—
SERENITY
SERENIDAD
SÉRÉNITÉ



(EN) This next-generation lamp's hallmark is its purity, simplicity and the timelessness of its lines. Each of its characteristics has been included to add a specific value.

(ES) La seña de identidad de esta lámpara de última generación se encuentra en la pureza, sencillez y atemporalidad de sus líneas. Cada uno de sus detalles han sido incorporados para ofrecer un valor determinado.

(FR) La caractéristique de cette lampe dernière génération se trouve dans la pureté, la simplicité et l'intemporalité de ses lignes. Chacun des détails a été intégré pour apporter une certaine valeur.



* Technical information pg. 208
* Información técnica pág. 208
* Information technique page 208

UMBRELLA

by WIS Design

Pendant | Suspensión | Suspension



—
RADIANT
RADIANTE
RAYONNANT

(EN) This luminaire draws its design inspiration from an umbrella on a sunny day, with the sun's rays shining through the fabric creating soft reflections of light. It is available in two sizes and two colour combinations: black and gold or white and silver.

(ES) Esta luminaria debe su diseño a un paraguas en un día soleado en el que los rayos de sol atraviesan su tela creando suaves reflejos de luz. Está disponible en dos tamaños y en dos combinaciones de colores: negro/dorado o blanco/plata.

(FR) Ce luminaire évoque un parasol qui laisse passer les rayons du soleil à travers son tissu, de manière à créer de doux reflets de lumière. Disponible en deux dimensions et deux combinaisons de couleur : noir/doré ou blanc/argent.

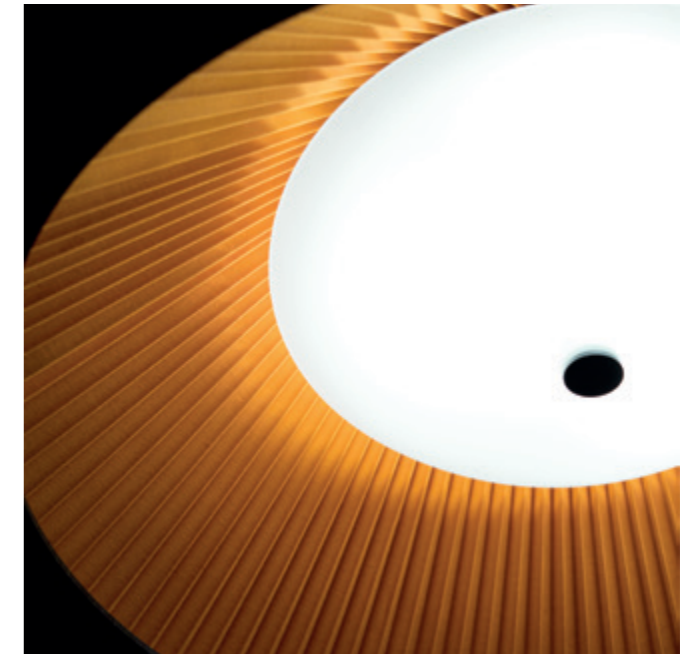

* Technical information pg. 217
* Información técnica pág. 217
* Information technique page 217

HELLO

by Josep Patsí



—
HARMONY
ARMONÍA
HARMONIE

(EN) The sea and waves are the main source of inspiration. Its shapes and contrasts generate an intimate atmosphere through warm and comfortable light. Lending its personality to wherever it is installed and its visual comfort harmonises spaces with different styles.

(ES) El mar y sus olas son su principal inspiración. Sus formas y contrastes generan un clima íntimo mediante una luz cálida y confortable. Otorga personalidad donde se ubica y su confort visual armoniza espacios de diferentes estilos.

(FR) La mer et ses vagues sont sa principale source d'inspiration. Ses formes et ses contrastes créent une atmosphère intime avec une lumière chaude et confortable. Elle apporte de la personnalité à l'endroit où elle se trouve et son confort visuel harmonise les espaces de styles différents.

RINGOFIRE

by Francesc Vilaró



—
COMFORT
CONFORTABILIDAD
CONFORT

(EN) A reinterpretation and update to the traditional pendant lamp with LED technology. Its timeless design is suited for use in both domestic and contract spaces. The full-empty concept incorporated in its volumes gives it visual lightness and optimum lighting comfort.

(ES) Reinterpretación y actualización de las tradicionales lámparas de suspensión con tecnología LED. Su diseño atemporal encaja tanto en el uso doméstico como en espacios contract. El concepto lleno-vacío en los volúmenes la dota de ligereza visual y de óptimo confort lumínico.

(FR) Réinterprétation et actualisation des traditionnelles lampes à suspension avec la technologie LED. Son design intemporel correspond aussi bien à un usage domestique qu'à des espaces professionnels. Les volumes de concept vide-plein lui donnent une légèreté visuelle optimale et un confort d'éclairage.

CIRC

by Josep Patsí

Pendant | Suspensión | Suspension



—
LIGHTNESS
LIGEREZA
LÉGÈRETÉ

(EN) The design of this pendant lamp offers diffuse lighting and provides great versatility in any space. It can be installed in a circular or linear format in a combination of different shapes and sizes.

(ES) El diseño de esta luminaria de suspensión ofrece una iluminación muy difusa y permite una gran versatilidad en los espacios. Puede instalarse de manera circular o lineal y realizar combinaciones de formas y tamaños diferentes.

(FR) Le design de ce luminaire en suspension offre un éclairage très diffus et permet une grande polyvalence dans l'espace. On peut l'installer de manière circulaire ou linéaire et réaliser des combinaisons de formes et de dimensions différentes.



* Technical information pg. 186
* Información técnica pág. 186
* Information technique page 186

NET

by Josep Patsí

Pendant | Suspensión | Suspension



—
PURITY
PUREZA
PURETÉ



(EN) Its flat, slimline design with very clean forms allows it to be used in various formats and applications within any space. Discreet, but at the same time versatile, this piece is available in a circular or oval shape.

(ES) Su diseño plano, delgado y de formas muy limpias le permite varios formatos y aplicaciones en el espacio. Discreta y versátil al mismo tiempo, esta pieza está disponible en forma de circunferencia u óvalo.

(FR) Son design plat, fin et aux formes très épurées lui permet d'adopter différents formats et applications dans l'espace. À la fois discret et polyvalent, ce modèle est disponible en forme de circonférence ou d'ovale.

3.

WALL
PARED
MURAL

TUBS
112
ELY
116
VOILES
122
INVISIBLE
126
BIG BANG
130

HALL
132
BEND
134
PRIME
136
SKATA
138
FLAVIA
140

TUBS

by Nahtrang Disseny

(EN) Tubs is a wall fixture that plays with light, casting geometric shapes on your walls. The linear light source has a broad capacity for movement, providing the space with energy and character.

(ES) Tubs es un aplique que representa el juego con la luz, que permite dibujar formas geométricas sobre una pared. La fuente de luz en forma lineal tiene una amplia capacidad de movimientos, dotando de dinamismo y carácter al espacio.

(FR) Tubs est une applique qui permet de jouer avec la lumière et de dessiner des formes géométriques sur un mur. La source lumineuse sous forme linéaire possède une grande capacité de mouvement qui confère dynamisme et caractère à l'espace.

* Technical information pg. 211

* Información técnica pág. 211

* Information technique page 211

—
INTERACTION
INTERACCIÓN
INTERACTION



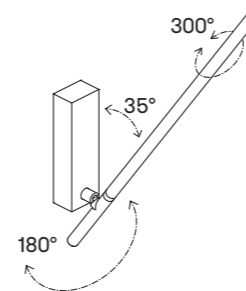

Wide range of movement: both light source and light axis swivel. | Amplia capacidad de movimientos: rotación tanto de la fuente de luz como de su eje. | Large gamme de mouvements : rotation tant de la source lumineuse que de son axe.

ELY

by Luca Turrini

(EN) Luca Turrini's minimalist design redesigns the classic headboards or wall lights to provide a more versatile, architectural solution integrated into the space. The elliptical shape allows, that with a slight adjustment of the screen and axis, to create different light effects for each space or area where it is used.

The different finishes along with the recessed or surface options offer a wide range of elements to create different ambiances.

(ES) El diseño minimalista de Luca Turrini reinterpreta el clásico aplique de cama o de pared para aportar una solución más arquitectónica, versátil e integrada en el entorno. Su forma elíptica permite, con un suave movimiento de pantalla y sobre su eje, crear diferentes efectos de luz para cada espacio o rincón donde se ubica.

Las diferentes opciones de acabados y su versión empotrada o de superficie ofrecen un gran abanico de elementos para construir distintos ambientes.

(FR) Le design minimaliste de Luca Turrini réinterprète l'applique murale ou de lit classique pour apporter une solution plus architecturale et polyvalente qui se fond dans le décor. La forme elliptique de ce modèle permet, par un doux mouvement d'abat-jour sur son axe, de créer différents effets de lumière dans chaque espace où il se trouve.

Les nombreuses finitions et sa version encastrée ou de surface offrent un grand éventail d'éléments qui permettent de créer des ambiances variées.

* Technical information pg. 196

* Información técnica pág. 196

* Information technique page 196

—
VERSATILE LIGHT
LUZ VERSÁTIL
LUMIÈRE POLYVALENTE







(EN) The light can be directed using the 360° rotation of its axis. Available in a white, gold or chrome finish and with or without button.

(ES) Su luz se dirige gracias a la rotación 360° de sus ejes. Disponible en acabado blanco, dorado y cromado, con y sin botón.

(FR) On dirige l'éclairage par rotation de ses axes à 360°. Disponible en blanc, doré et chromé, avec et sans bouton.

VOILES

by Céline Wright

(EN) Voiles pushes the envelope of contemporary design for large spaces with a style of sculpture far removed from conventional materials and shapes, opting for traditional craftsmanship.

On the one hand, its asymmetric shape provides a different vision depending on your position. On the other hand, the Japanese Washi paper gives the piece a lightness that allows constant movement.

Together they create a poetic living piece that makes any space more beautiful.

(ES) Voiles desafía el diseño contemporáneo de grandes espacios con una escultura que huye de las formas y materiales convencionales, y apuesta por el trabajo artesanal.

Por un lado, su forma asimétrica permite una visión distinta según el punto de mira. Y de otra parte, el papel Washi japonés otorga a la pieza una ligereza que permite un constante movimiento.

Juntos crean una pieza poética viva que embellece cualquier espacio.

(FR) Voiles défie le design contemporain des grands espaces avec une sculpture qui fuit les formes et les matériaux conventionnels et mise sur le travail artisanal.

D'une part, sa forme asymétrique permet une vision différente en fonction du point de vue. D'autre part, le papier japonais Washi confère à la pièce une légèreté qui permet un mouvement constant.

Le tout crée une pièce poétique vivante qui embellit n'importe quel espace.

* Technical information pg. 218

* Información técnica pág. 218

* Information technique page 218

—
CRAFTSMANSHIP IN MOVEMENT
ARTESANÍA EN MOVIMIENTO
ARTISANAT EN MOUVEMENT





The wall light cables can be tightened and the hook can be installed at the desired height. | El aplique permite tensar sus cables y colocar su gancho a la altura que se desea. | L'applique permet de serrer les câbles et de placer le crochet à la hauteur désirée.

INVISIBLE

by Francesc Vilaró

(EN) Invisible is intuition, functionality and beauty. A design based on the balance between these concepts, that transmits a feeling of weightlessness like a ceiling mobile. The different positions of its head and arm create multiple compositions that mean the light can be moulded and directed as you please, integrating it into the space.

Its beauty lies in its simplicity and makes it an iconic piece. In 2016, Invisible by Francesc Vilaró was awarded the German Design Award.

(ES) Invisible es intuición, funcionalidad y ligereza. Un diseño basado en el equilibrio de estos conceptos que transmite una percepción de ingravidez que nos recuerda a un móvil. Las diferentes posiciones de su cabezal y su brazo generan múltiples composiciones que permiten moldear y direccionar la luz donde deseemos, integrándola en el espacio.

En su simplicidad radica su belleza y la convierte en un elemento icónico. En 2016, Invisible de Francesc Vilaró fue galardonada con el German Design Award.

(FR) Invisible est synonyme d'intuition, de fonctionnalité et de légèreté. Sa ligne repose sur l'équilibre de ces concepts et transmet une perception d'apesanteur qui évoque un mobile. Les différentes positions de sa tête et de son bras génèrent de nombreuses compositions qui permettent de moduler et de diriger la lumière là où on le désire, l'intégrant ainsi dans l'espace.

La beauté de ce modèle réside dans sa simplicité pour en faire un élément emblématique. En 2016, Invisible de Francesc Vilaró a reçu le German Design Award.

* Technical information pg. 203

* Información técnica pág. 203

* Information technique page 203

—
SIMPLICITY AND BALANCE
SIMPLICIDAD Y EQUILIBRIO
SIMPLICITÉ ET ÉQUILIBRE





The rotating head means the light can be directed. | La rotación del cabezal permite dirigir la luz. | La rotation de la tête permet de diriger la lumière.



BIG BANG

by Francesc Vilaró

(EN) This appealing wall lamp with LED technology is a sensory explosion of light. The indirect light generated by this luminaire is reflected onto gold-coloured metal creating a sensual halo of light that produces different effects by day or night.

(ES) Este sugerente aplique con tecnología LED es un estallido sensorial de luz. La luz indirecta que genera esta luminaria se refleja sobre una pieza de metal dorado que crea un halo lumínico sensual produciendo diferentes efectos de día o de noche.

(FR) Cette applique suggestive dotée de la technologie LED est une explosion sensorielle de lumière. La lumière indirecte générée par ce luminaire est réfléchiée sur une pièce de métal dorée qui crée un halo lumineux sensuel produisant différents effets de jour ou de nuit.

* Technical information pg. 183

* Información técnica pág. 183

* Information technique page 183

—
SENSUALITY
SENSUALIDAD
SENSUALITÉ



HALL

by Nahtrang Disseny

(EN) With a contemporary style, this wall lamp is the centrepiece of a family designed and created to meet the needs of hotels. Its careful lines and shapes, and square cross-section, make this luminaire a unique piece.

(ES) De diseño contemporáneo, este aplique es el núcleo de una familia ideada y creada para cubrir las necesidades de los hoteles. Sus líneas y formas cuidadas, y de sección cuadrada, hacen a esta luminaria una pieza única.

(FR) Au design contemporain, cette applique est au cœur d'une gamme conçue et pensée pour répondre aux besoins des hôtels. Ses lignes, ses formes soignées, et sa section carrée font de ce luminaire une pièce unique.

* Technical information pg. 198

* Información técnica pág. 198

* Information technique page 198



—
SIMPLICITY
SIMPLICIDAD
SIMPLICITÉ



BEND

by Benedito Design

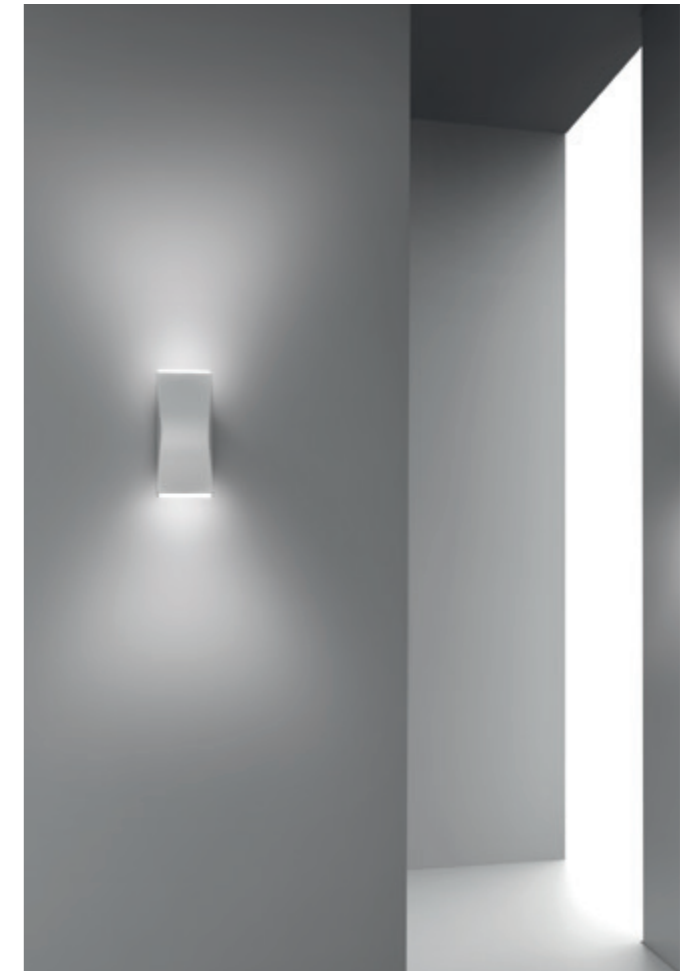

—
FUNCTIONALITY
FUNCIONALIDAD
FONCTIONNALITÉ

(EN) With forceful straight lines, this front-facing wall lamp is focused in the centre and expands outwards to increase the dimensions of the two windows at the sides. The inclination of these windows controls the distribution of the light halo to give it a strong personality.

(ES) De formas lineales y contundentes, este aplique frontal se ciñe en el centro y se expande hacia los límites para incrementar la dimensión de las dos ventanas situadas en los extremos. La inclinación de estas orienta la difusión del halo luminoso dotándola de una fuerte personalidad.

(FR) Aux formes linéaires et contondantes, cette applique frontale se tient au centre et s'élargit vers les limites pour augmenter la taille des deux fenêtres situées aux extrémités. L'inclinaison de celles-ci oriente la diffusion du halo lumineux en lui donnant une forte personnalité.

PRIME

by Josep Patsí



—
POWER
POTENCIA
PUISSANCE



(EN) A fundamental and necessary piece in any interior design project since its simple geometry easily integrates into any space. It combines simplicity and delicacy of form with the most powerful LED lighting available on the market.

(ES) Es una pieza básica y necesaria en todo proyecto de interior por su geometría simple y fácil de integrar en cualquier espacio. Combina la simplicidad y la suavidad de sus formas con la iluminación LED más potente y disponible del mercado.

(FR) C'est une pièce de base nécessaire dans tout projet d'intérieur de par sa géométrie simple et facile à intégrer dans tous les espaces. Il allie la simplicité et la douceur de ses formes avec l'éclairage LED le plus puissant disponible sur le marché.

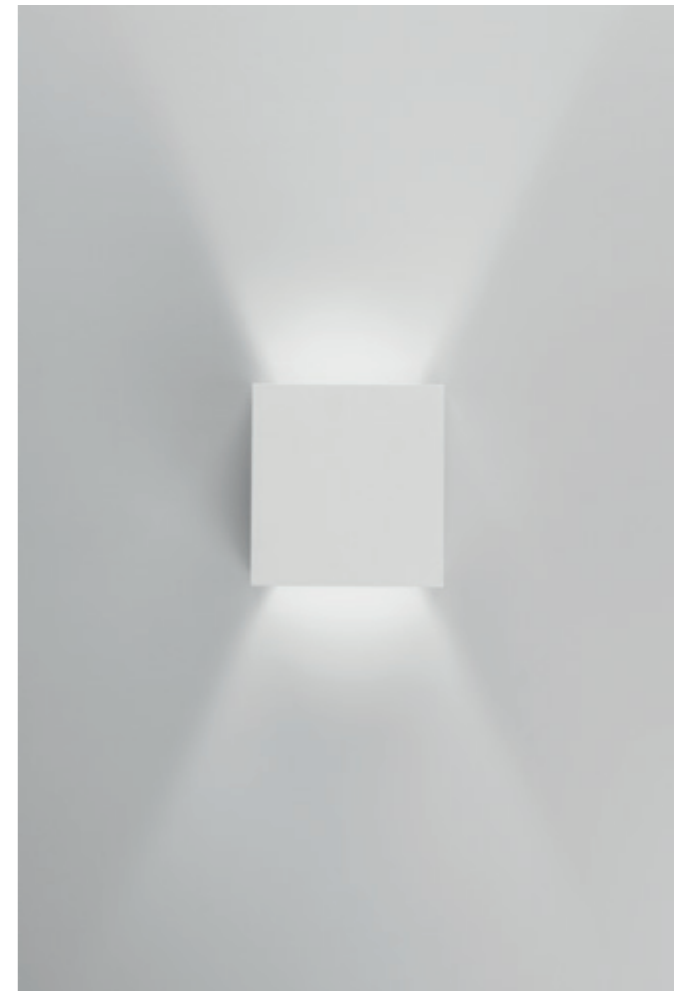

* Technical information pg. 207
* Información técnica pág. 207
* Information technique page 207

SKATA

by Francesc Vilaró



—
VERSATILITY
VERSATILIDAD
POLYVALENCE



(EN) Formed of organic pieces, this sophisticated composition is a reflection of ordered chaos. The inclination of its pieces adds a sensation of volume to the compositions that work whether or not they are switched on.

(ES) Formado por piezas de formas orgánicas, este sofisticado juego de composición se presenta como un caos ordenado. La inclinación de las piezas añade una sensación de volumen en las composiciones que funcionan tanto cuando está encendida como apagada.

(FR) Formé par des pièces aux formes organiques, ce jeu de composition sophistiqué se présente comme un chaos ordonné. L'inclinaison des pièces ajoute une sensation de volume dans les compositions qui fonctionnent à la fois quand elle est allumée ou éteinte.

FLAVIA

by Bedito Design

(EN) With an unforgettable design that stands out from the rest, the shape of this luminaire is based on an audacious gesture, a touch of distinction, making it ideal for residential and hotel environments.

(ES) Con un diseño para recordar y diferenciarse, la forma de esta luminaria se basa en un gesto audaz, en un toque de distinción, pensada para entornos residenciales y hoteleros.

(FR) Avec un design différent dont on se souviendra, la forme de ce luminaire part d'un geste audacieux, d'une touche de classe, conçue pour les environnements résidentiels et hôteliers.

* Technical information pg. 197

* Información técnica pág. 197

* Information technique page 197



—
DISTINCTION
DISTINCIÓN
DISTINCTION





TABLE
SOBREMESA
TABLE

TUBS
144
COCKTAIL
148
ILARGI
154

INVISIBLE
156
HALL
158
PREMIUM
160

TUBS

by Nahtrang Disseny

(EN) Tubs is a desk lamp that plays with light, which casts geometric shapes. The linear light source has a broad capacity for movement, providing the space with energy and character. Its black marble base gives it an elegant and high-quality look. This is a very versatile piece, whether for more household, leased or office spaces.

(ES) Tubs es un sobremesa que representa el juego con la luz, que permite dibujar formas geométricas. La fuente de luz en forma lineal tiene una amplia capacidad de movimientos, dotando de dinamismo y carácter al espacio. Su base es de mármol negro, lo que le confiere un aspecto de distinción y de gran calidad. Una pieza muy versátil, ya sea para espacios más domésticos, contract u oficinas.

(FR) Tubs est une lampe à poser qui permet de jouer avec la lumière et de dessiner des formes géométriques. La source de lumière sous forme linéaire possède une grande capacité de mouvement qui confère dynamisme et caractère à l'espace. En marbre noir, son socle lui donne un aspect distingué et de grande qualité. Pièce très polyvalente conçue pour des espaces plus domestiques, ainsi que pour l'équipement « contract » ou de bureaux.

* Technical information pg. 212

* Información técnica pág. 212

* Information technique page 212

—
INTERACTION
INTERACCIÓN
INTERACTION



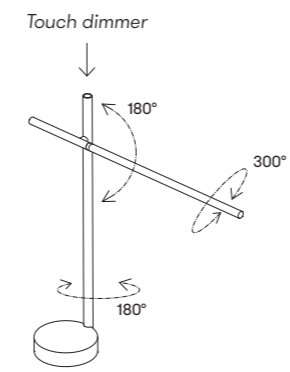

Wide range of movement: both light source and light axis swivel. | Amplia capacidad de movimientos: rotación tanto de la fuente de luz como de su eje. | Large gamme de mouvements : rotation tant de la source lumineuse que de son axe.

Black marble base. | Base en mármol negro. | Socle en marbre noir.



COCKTAIL

by Francesc Vilaró

(EN) Cocktail by Francesc Vilaró is balance. Creativity and industrialisation. Innovation and aesthetics. A portable lamp that works for you, creating and suggesting perfect atmospheres in restaurants, hotels, terraces and homes.

Its versatile design, with timeless shapes in black and white means you can invent atmospheres by creating compositions with different light points.

(ES) Cocktail de Francesc Vilaró es equilibrio. Creatividad e industrialización. Innovación y estética. Una lámpara portátil que te acompaña, crea y sugiere atmósferas perfectas en restaurantes, hoteles, terrazas y residencias.

Su diseño versátil, de geometrías atemporales en blanco o negro, permite inventar ambientes creando composiciones con diferentes puntos de luz.

(FR) Cocktail, de Francesc Vilaró, est tout en équilibre. Créativité et industrialisation. Innovation et esthétique. Cette lampe portable vous accompagne en créant des ambiances parfaites en hôtel-restauration, en terrasse et en milieu résidentiel.

Arborant une géométrie intemporelle en blanc ou noir, sa ligne polyvalente permet d'inventer des ambiances en créant des compositions dotées de plusieurs points lumineux.

* Technical information pg. 194

* Información técnica pág. 194

* Information technique page 194

—
 LIGHT THAT WORKS FOR YOU
 LA LUZ QUE TE ACOMPAÑA
 LA LUMIÈRE QUI VOUS ACCOMPAGNE





(EN) Its 4 dimmer settings (100 % - 75 % - 50 % - 25 %) help to create the perfect environment for each moment. Also, its high-quality battery lasts for up to 10 hours at 100 % capacity and for even longer if the light is dimmed.

(ES) Sus 4 pasos de regulación (100 % - 75 % - 50 % - 25 %) ayudan a crear el ambiente idóneo para cada momento. Además, su batería de alta calidad dura hasta 10 h con el 100 % de la luz y su duración aumenta si se atenúa la luz.

(FR) Ses 4 niveaux de réglage (100 % - 75 % - 50 % - 25 %) aident à créer le décor parfait en toute occasion. En outre, sa batterie de qualité supérieure dure jusqu'à 10 heures à 100 % d'éclairage et plus longtemps si la lumière est atténuée.





360° directable head. | Cabeza orientable 360°. |
Tête orientable à 360°.



ILARGI

by Iratzoki Lizaso

(EN) Produced using a traditional Polish glassblowing technique, the glass ball comes in two sizes: 23 cm and 39 cm. The detailed selection of finishes and the dimmer touch on the upper part of the light create a natural ambience.

(ES) La bola de vidrio disponible en dos tamaños, 23 cm y 39 cm, ha sido soplada a mano de manera tradicional en Polonia. La selección minuciosa de sus acabados y su atenuador táctil en la parte superior ofrece una cierta sensación de naturalidad.

(FR) Disponible en deux dimensions, 23 cm et 39 cm, la boule de ce modèle a été fabriquée en Pologne selon la technique traditionnelle du verre soufflé à la main. La sélection minutieuse de ses finitions et l'atténuateur tactile situé sur la partie supérieure lui confèrent une certaine sensation de naturel.

* Technical information pg. 202

* Información técnica pág. 202

* Information technique page 202

—
NATURALNESS
NATURALIDAD
TOUT EN NATUREL



INVISIBLE

by Francesc Vilaró

(EN) Invisible is intuition, functionality and lightness but, above all, simplicity. And this characteristic is the source of its beauty. Its simplicity gives it an intrinsic iconic quality.

(ES) Invisible es intuición, funcionalidad y ligereza, pero sobre todo simplicidad. Y es en esta característica donde radica su belleza. Su simplicidad la convierte en un elemento icónico por sí mismo.

(FR) Invisible est intuition, fonctionnalité et légèreté, mais surtout simplicité. Et c'est dans cette caractéristique que se trouve sa beauté. Sa simplicité en fait un élément emblématique par lui-même.

* Technical information pg. 204

* Información técnica pág. 204

* Information technique page 204

—
AUTHENTICITY
AUTENTICIDAD
AUTHENTICITÉ



HALL

by Nahtrang Disseny

(EN) The main attraction of this collection is the identity conveyed by its contemporary lines without losing the simplicity and neutrality that allows it to coexist in spaces with different styles.

(ES) El principal atractivo de esta colección es la identidad que transmite su línea contemporánea sin perder la simplicidad y la neutralidad que le permite convivir en espacios de diferentes estilos.

(FR) Le principal atout de cette collection est l'identité que transmet sa ligne contemporaine sans perdre la simplicité et la neutralité qui lui permettent de s'intégrer dans des espaces de styles différents.

* Technical information pg. 200

* Información técnica pág. 200

* Information technique page 200



—
SIMPLICITY
SIMPLICIDAD
SIMPLICITÉ



PREMIUM

by Jordi Llopis



—
WARMTH
CALIDEZ
CHALEUR

(EN) This table lamp has a classic but contemporary design, a stand with a copper or gold finish and a black screen. Switched on or off, its appearance makes it an ideal type of light for bedrooms and communal areas in hotels.

(ES) Pieza de sobremesa de diseño clásico y contemporáneo con pie de acabados en cobre u oro y pantalla negra. Su presencia, tanto apagada como encendida, la sitúa como una iluminaria ideal para habitaciones y zonas comunes de hoteles.

(FR) Lampe à poser au design classique et contemporain associant un pied aux finitions cuivre ou or et un abat-jour noir. Éteint comme allumé, ce modèle à forte présence est idéal pour les chambres et les espaces publics des hôtels.

5.

FLOOR
PIE
PIED

TUBS
164
INVISIBLE
168
CIRC
172

HALL
174
PREMIUM
176
FLAVIA
178

TUBS

by Nahtrang Disseny

(EN) Tubs is a floor lamp that plays with light, casting geometric shapes in your space. The linear light source has a broad capacity for movement, providing the space with energy and character. Its black marble base gives it an elegant and high-quality look. This is a highly versatile piece, whether for more household, leased or office spaces.

(ES) Tubs es un pie de salón que representa el juego con la luz, lo que permite dibujar formas geométricas. La fuente de luz en forma lineal tiene una amplia capacidad de movimientos, dotando de dinamismo y carácter al espacio. Su base es de mármol negro, lo que le confiere un aspecto de distinción y de gran calidad. Una pieza muy versátil, ya sea para espacios más domésticos, contract u oficinas.

(FR) Tubs est un lampadaire qui permet de jouer avec la lumière et de dessiner des formes géométriques. La source de lumière sous forme linéaire possède une grande capacité de mouvement qui confère dynamisme et caractère à l'espace. En marbre noir, son socle lui donne un aspect distingué et de grande qualité. Pièce très polyvalente conçue pour des espaces plus domestiques, ainsi que pour l'équipement « contract » ou de bureaux.

* Technical information pg. 212

* Información técnica pág. 212

* Information technique page 212

—
INTERACTION
INTERACCIÓN
INTERACTION





Wide range of movement: both light source and light axis swivel. | Amplia capacidad de movimientos: rotación tanto de la fuente de luz como de su eje. | Large gamme de mouvements : rotation tant de la source lumineuse que de son axe.

Black marble base. | Base en mármol negro. | Socle en marbre noir.

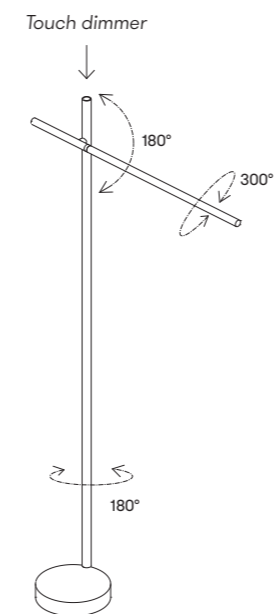

INVISIBLE

by Francesc Vilaró

(EN) Its minimalist design is also reflected in its component parts: which are stripped down to the basics necessary to allow it to perform its function. This lamp has three essential components: a LED light source, two identical circumferences that act as counterweights for one another and a thin tube connecting them.

(ES) Su diseño minimalista también se refleja en los elementos que la componen: los justos y necesarios para cumplir su funcionalidad. Tres son sus componentes esenciales: fuente de luz LED, dos circunferencias homólogas que trabajan como contrapeso entre sí y un tubo delgado que los une.

(FR) Son design minimaliste se reflète aussi dans les éléments qui la composent : justes et nécessaires pour remplir leur fonction. Trois composants sont essentiels : source de lumière LED, deux circonférences semblables travaillant comme un contrepoids entre elles, et un mince tube qui les relie.

* *Technical information pg. 204*

* *Información técnica pág. 204*

* *Information technique page 204*

—
AUTHENTICITY
AUTENTICIDAD
AUTHENTICITÉ





CIRC

by Josep Patsí

(EN) This luminaire offers minimalist expression with minimal volume, but it is capable of filling any space due to its highly effective light diffusion. It gives a sensation of lightness and it appears as though the piece is emitting its own light.

(ES) Es la mínima expresión con un mínimo volumen, pero con la capacidad de llenar cualquier espacio por la difusión de su iluminación. Aporta una sensación de ligereza y de que la pieza tiene una iluminación propia.

(FR) Réduit à sa plus simple expression dans un minimum de volume, ce modèle sait néanmoins remplir n'importe quel espace par la diffusion de sa lumière. Il apporte une sensation de légèreté et de lumière qui émane de nulle part.

* Technical information pg. 186

* Información técnica pág. 186

* Information technique page 186

—
LIGHTNESS
LIGEREZA
LÉGÈRETÉ



HALL

by Nahtrang Disseny

(EN) This collection has been created to make it an essential element of the hotel sector that also enhances the design of its surroundings thanks to the definition of its lines and its more detailed shapes.

(ES) Esta colección se ha creado para posicionarse como una pieza básica en el sector hotelero pero que ofrece un plus en el diseño gracias a la definición de sus líneas y de sus formas más detalladas.

(FR) Cette collection a été créée pour se positionner comme une pièce basique dans le secteur hôtelier, mais offre un plus dans son design grâce à la définition de ses lignes et de ses formes plus détaillées.

* Technical information pg. 200

* Información técnica pág. 200

* Information technique page 200

—
SIMPLICITY
SIMPLICIDAD
SIMPLICITÉ



PREMIUM

by Jordi Llopis



Floor | Pie | Pied

—
WARMTH
CALIDEZ
CHALEUR

(EN) With a copper or gold finish and black screen, this light is highly distinctive. Switched off, it is like a sculpture that gives character to a particular space and, switched on, it provides a warm and sophisticated light.

(ES) Esta iluminaria de acabados cobre u oro y pantalla negra tiene mucha presencia. Apagada actúa como una escultura que ayuda a construir el espacio y, encendida proporciona una luz cálida y elegante.

(FR) Doté de finitions cuivre ou or et d'un abat-jour noir, ce luminaire possède une forte présence. Éteint, il agit comme une sculpture qui aide à modeler l'espace, tandis qu'allumé il offre une lumière chaude et élégante.

* Technical information pg. 206
* Información técnica pág. 206
* Information technique page 206



FLAVIA

by *Benedito Design*

(EN) With minimal impact, this piece adds character and provides expressiveness wherever it is installed. Furthermore, great efforts have been made to ensure design consistency between all the pieces to help unify the range.

(ES) Se trata de una pieza que imprime carácter y que aporta expresividad, mediante una mínima intervención, en los espacios donde se coloca. Además, se ha cuidado la coherencia en el diseño de todas las piezas que ayuda a unificar toda la gama.

(FR) Il s'agit d'une pièce qui donne du caractère et apporte de l'expressivité grâce à une intervention minimale dans les espaces où elle est placée. En outre, la cohérence a été soignée dans la conception de toutes les pièces aidant ainsi à unifier toute la gamme.

* *Technical information pg. 197*

* *Información técnica pág. 197*

* *Information technique page 197*

—
DISTINCTION
DISTINCIÓN
DISTINCTION



INFORMATION
INFORMACIÓN
INFORMATION

ALIVE

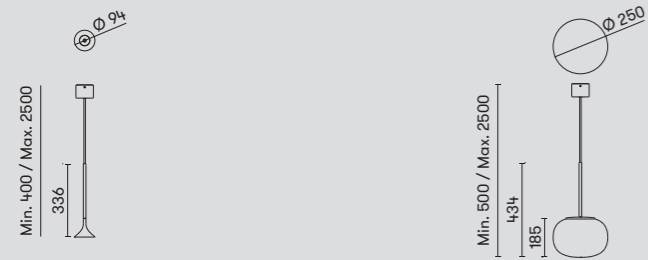

00-6670-05-05 ■ (1-10V)
 00-6670-21-21 ■ (1-10V)
 100-240V

LED 6.9W A++ A
 575 lm 2700K

00-6671-05-F1 ■ (1-10V)
 00-6671-21-F1 ■ (1-10V)
 100-240V

LED 6.9W A++ A
 575 lm 2700K



Finishings | Acabados | Finitions

05 Black | Negro | Noir
 21 Chrome | Cromo | Chrome

Materials | Materiales | Matériaux

AL Aluminium | Aluminio | Aluminium
 PMMA Diffuser material PMMA | Material difusor PMMA | Materiau diffusant PMMA
 GLASS Diffuser material glass | Material difusor Cristal | Materiau diffusant verre

New ceiling rose system for a variety of compositions | Nuevo sistema de florón para crear composiciones distintas | Nouveau système de montage permettant de créer différentes compositions

6 9 18 30

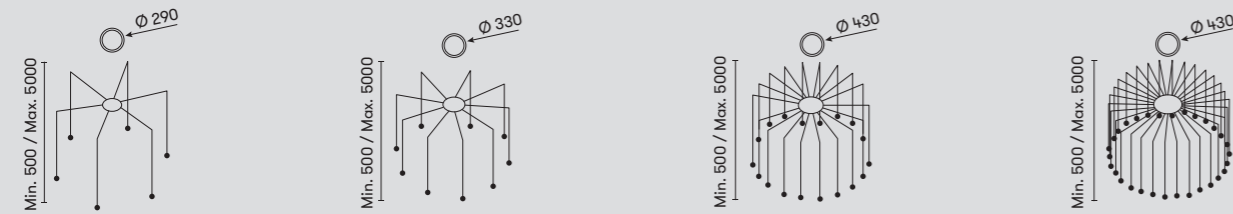

00-7064-05-05 ■ (1-10V)
 00-7064-21-21 ■ (1-10V)
 00-7074-05-05 ■ (Dali)
 00-7074-21-21 ■ (Dali)

LED 41.1W A++ A
 3450 lm 2700K

00-7065-05-05 ■ (1-10V)
 00-7065-21-21 ■ (1-10V)
 00-7075-05-05 ■ (Dali)
 00-7075-21-21 ■ (Dali)

LED 61.7W A++ A
 5175 lm 2700K

00-7066-05-05 ■ (1-10V)
 00-7066-21-21 ■ (1-10V)
 00-7076-05-05 ■ (Dali)
 00-7076-21-21 ■ (Dali)

LED 123.4W A++ A
 10350 lm 2700K

00-7067-05-05 ■ (1-10V)
 00-7067-21-21 ■ (1-10V)
 00-7077-05-05 ■ (Dali)
 00-7077-21-21 ■ (Dali)

LED 210W A++ A
 17250 lm 2700K

BEND

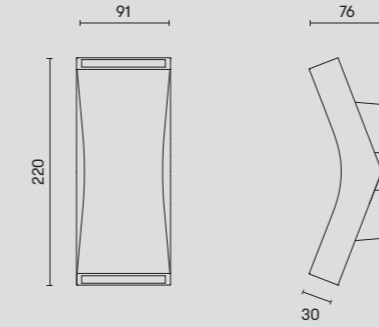

05-4394-78-M1 ■ (1-10V)
 05-4394-AH-M1 ■ (1-10V)
 100-240V

LED CREE 4.5W A++ A
 880 lm 3000K



Finishings | Acabados | Finitions

78 White lacquered | Lacado blanco | Laqué en blanc
 AH Ecobright aluminium | Aluminio ecobright | Aluminium Ecobright

Materials | Materiales | Matériaux

AL Aluminium | Aluminio | Aluminium
 PMMA Diffuser material PMMA | Material difusor PMMA | Materiau diffusant PMMA

BIG BANG

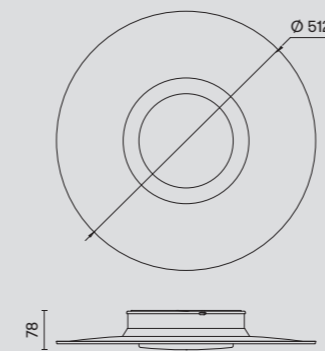

05-5085-BW-BW ■ (1-10V)
 100-240V

LED 9W (Back) 765 lm 3000K
 +
 LED 13.5W (Front) A++ A 1147 lm 3000K



Finishings | Acabados | Finitions

BW Matt white | Blanco mate | Blanc mate
 27 Matt satin finished brass | Latón satinado mate | Laiton satiné mat

Materials | Materiales | Matériaux

AL Aluminium | Aluminio | Aluminium
 PMMA Diffuser material PMMA | Material difusor PMMA | Materiau diffusant PMMA

CANDLE

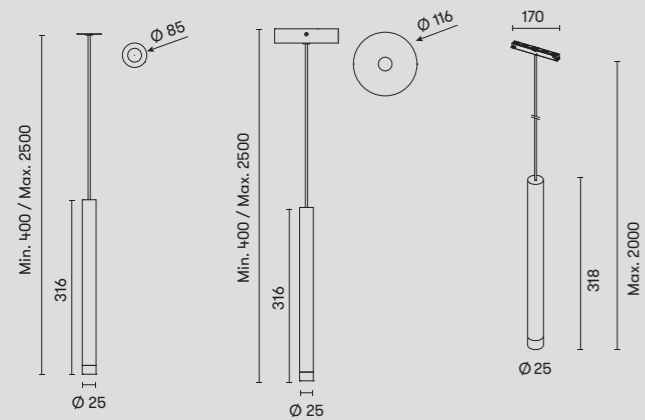

00-6018-27-27 00-6017-27-27 71-8320-05-27
 00-6018-60-60 00-6017-60-60 71-8320-05-60
 100-240V 100-240V
 LED 3.2W A++ A LED 3.2W A++ A
 358 lm 2700K 360 lm 2700K

Low Voltage
 Adapted to 48V rail | Adaptada a carril 48V |
 Adapté à rail de 48 V



Finishings | Acabados | Finitions

- 27 Matt satin finished brass | Latón satinado mate | Laiton satiné mat
- 60 Black | Negro | Noir

Materials | Materiales | Matériaux

- ST Steel | Acero | Acier
- PMMA Diffuser material PMMA | Material difusor PMMA | Matériau diffusant PMMA
- GLASS MAT Diffuser material matt glass | Material difusor vidrio mate | Matériau diffusant verre

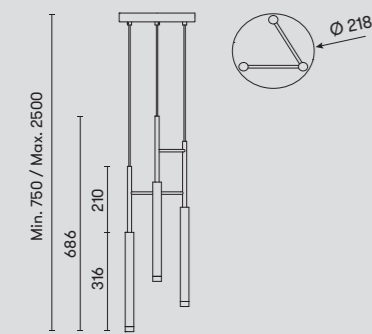

00-6021-27-27 (Mains dimming)
 00-6021-60-60 (Mains dimming)
 220-240V
 LED 3x3.2W A++ A
 1075 lm 2700K

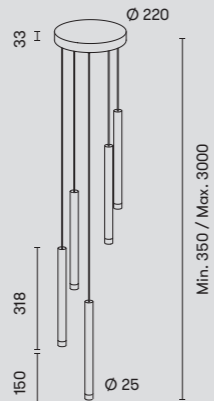

00-8317-60-27 (DALI)
 00-8317-60-60 (DALI)
 00-8318-60-27 (0-10V)
 00-8318-60-60 (0-10V)
 100-240V
 LED 5x3.2W A++ A
 844 lm 2700K

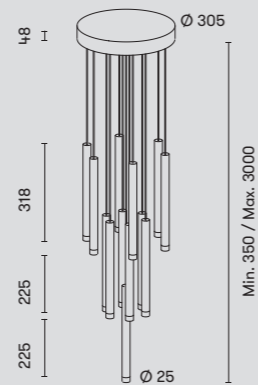

00-8319-60-27 (DALI)
 00-8319-60-60 (DALI)
 00-8320-60-27 (0-10V)
 00-8320-60-60 (0-10V)
 100-240V
 LED 13x3.2W A++ A
 2194 lm 2700K

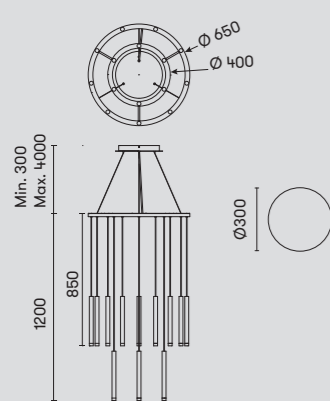

00-6019-27-27 (1-10V)
 00-6020-27-27 (DALI)
 100-240V
 LED 15x3W A++ A
 5452 lm 2700K

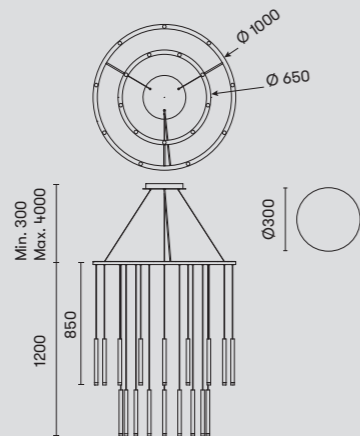

00-6066-27-27 (1-10V)
 00-6067-27-27 (DALI)
 100-240V
 LED 18x3W A++ A
 6700 lm 2700K

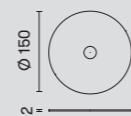

71-6022-27-27
 71-6022-60-60

Aluminium disc accessory | Accesorio disco de aluminio | Accessoire disque en aluminium



71-8318-F9-F9

Tinted glass diffuser accessory | Accesorio difusor vidrio matizado | Accessoire diffuseur en verre mat

New ceiling rose system for a variety of compositions | Nuevo sistema de florón para crear composiciones distintas | Nouveau système de montage permettant de créer différentes compositions

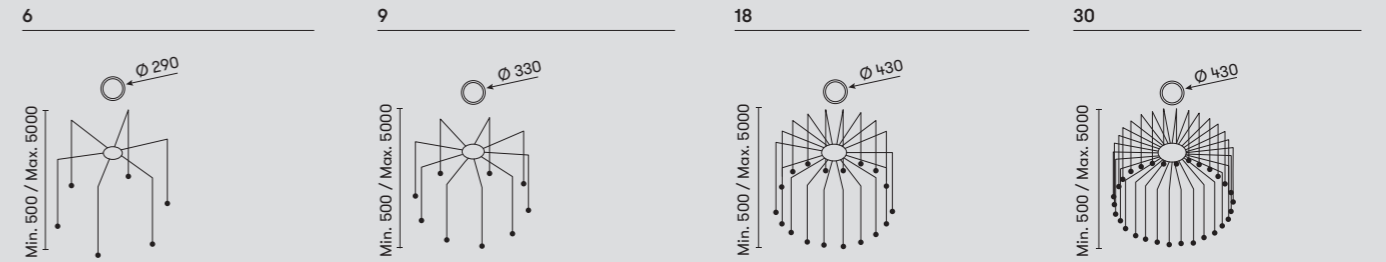

00-6662-14-27 (1-10V) 100-240V
 00-6663-14-27 (DALI) 220-240V
 00-6662-14-60 (1-10V) 100-240V
 00-6663-14-60 (DALI) 220-240V
 00-6664-14-27 (1-10V) 100-240V
 00-6665-14-27 (DALI) 220-240V
 00-6664-14-60 (1-10V) 100-240V
 00-6665-14-60 (DALI) 220-240V
 00-6666-14-27 (1-10V) 100-277V
 00-6667-14-27 (DALI) 100-277V
 00-6666-14-60 (1-10V) 100-277V
 00-6667-14-60 (DALI) 100-277V
 00-6668-14-27 (1-10V) 100-277V
 00-6669-14-27 (DALI) 100-277V
 00-6668-14-60 (1-10V) 100-277V
 00-6669-14-60 (DALI) 100-277V

LED 18.8W A++ A LED 28.1W A++ A LED 56.7W A++ A LED 98.8W A++ A
 2165 lm 2700K 3250 lm 2700K 6700 lm 2700K 10900 lm 2700K

The white ceiling rose can be painted matte black upon request. | Los florones de color blanco pueden ser pintados, bajo pedido, de negro mate. | Les bases d'alimentation de couleur blanche peuvent être peintes en noir mat sur demande.

CATENARIA

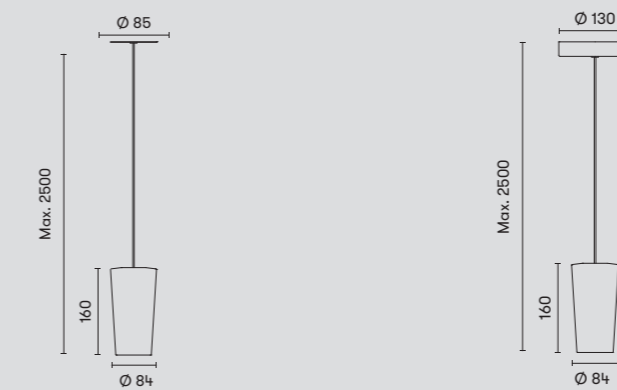

00-7615-14-55
 100-240V
 LED 6.7W A++ A
 580 lm 3000K

00-7614-21-55
 100-240V
 LED 6.3W A++ A
 580 lm 3000K

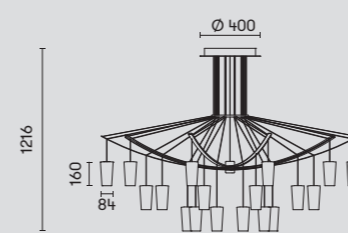

20-7612-21-55 (DALI)
 20-7613-21-55 (1-10V)
 100-240V
 LED 201W A++ A
 17400 lm 3000K

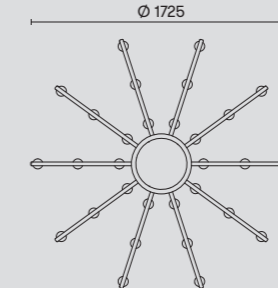

Finishings | Acabados | Finitions

- 14 White | Blanco | Blanc
- 21 Chrome | Cromo | Chrome

Materials | Materiales | Matériaux

- ST Steel | Acero | Acier
- MRBL Marble | Mármol | Marbre
- AL Aluminium | Aluminio | Aluminium
- ALB Alabaster | Alabastro | Alabastro
- PMMA PMMA | PMMA | PMMA
- GLASS OPAL3 Diffuser material triplex Opal glass | Material difusor cristal opal triplex | Matériau diffusant verre opal triplex

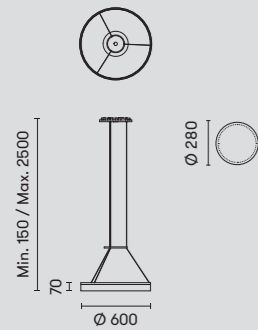

00-0001-BW-M3 (Standard)
 00-0641-BW-M3 (Dimmable 1-10V)
 100-240V

LED 22W A++ A
 2112 lm 3000K

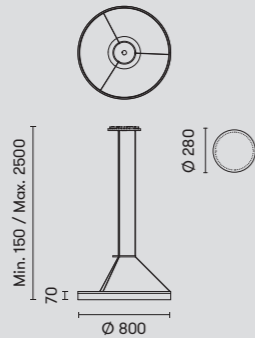

00-0002-BW-M3 (Standard)
 00-0642-BW-M3 (Dimmable 1-10V)
 100-240V

LED 31W A++ A
 2976 lm 3000K

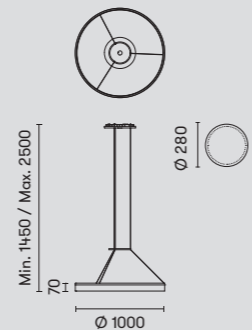

00-3642-BW-M3 (Standard)
 00-3646-BW-M3 (Dimmable 1-10V)
 100-240V

LED 36W A++ A
 3456 lm 3000K

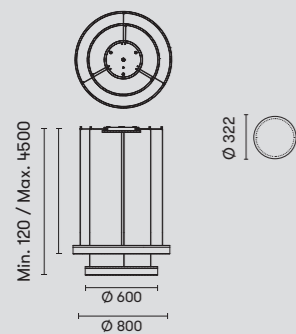

00-3647-BW-M3 (Standard)
 100-240V

LED 53W A++ A
 5088 lm 3000K

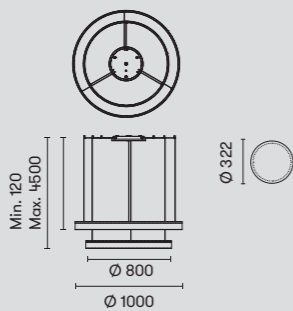

00-3648-BW-M3 (Standard)
 100-240V

LED 67W A++ A
 6432 lm 3000K

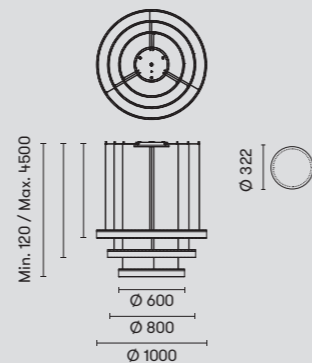

00-3649-BW-M3 (Standard)
 100-240V

LED 89W A++ A
 8544 lm 3000K



71-2241-00-00
 Controller with remote control for **Standard Version**
 Controlador con mando a distancia para **Versiones Standard**
 Contrôleur avec télécommande pour **Versions Standard**



* Dimmers compatible at www.leds-c4.com (Products & Downloads)
 * Compatibilidad con reguladores corte de fase en www.leds-c4.com (Productos & Descargas)
 * Compatible avec des variateurs en coupure de phase que vous pouvez consulter www.leds-c4.com (Produits & Téléchargements)

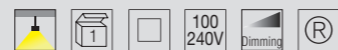

Finishings | Acabados | Finitions

BW Matt white | Blanco mate | Blanc mate

Materials | Materiales | Matériaux

AL Aluminium | Aluminio | Aluminium

PMMA Diffuser material PMMA | Material difusor PMMA | Matériau diffusant PMMA

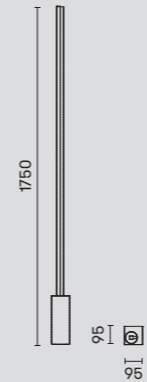

25-2934-BW-M3
 100-240V

LED 27W A++ A
 2.592 lm 3000K



Finishings | Acabados | Finitions

BW Matt white | Blanco mate | Blanc mate

Materials | Materiales | Matériaux

AL Aluminium | Aluminio | Aluminium

PMMA Diffuser material PMMA | Material difusor PMMA | Matériau diffusant PMMA



Accessory for transit areas
 Accesorio para zonas transitadas
 Accessoire pour zones de passage



Rotation movement 350°
 Movimiento rotación 350°
 Mouvement de rotation 350°

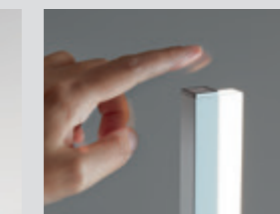

Touch dimmer

CIRCULAR



Light direction | Dirección de la luz | Direction de la lumière

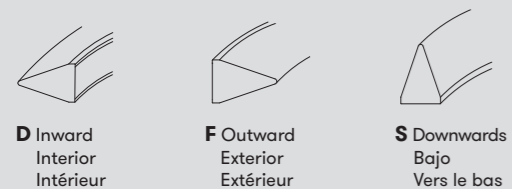

Ceiling rose | Tipo florón | Type de montage

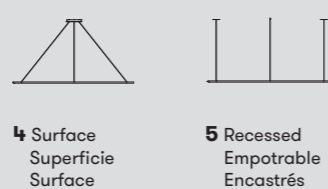

Model | Modelo | Modèle

 Min. 500 Max. 3000 A Ø600 mm 31.7W 2880 lm	 Min. 700 Max. 3000 K Ø900 mm 45W 4350 lm	 Min. 700 Max. 3000 B Ø1200 mm 63.5W 5760 lm	 Min. 800 Max. 5000 C Ø2000 mm 120W 10080 lm
 Min. 800 Max. 5000 D Ø3000 mm 178W 14880 lm	 Min. 1000 Max. 4000 Min. 1500 Max. 3000 G Ø3000 mm 368W Ø2000 mm 30720 lm Ø1200 mm	 Min. 1000 Max. 3000 Min. 1500 Max. 3000 H Ø2000 mm 224W Ø1200 mm 18720 lm Ø600 mm	 Min. 1000 Max. 3000 Min. 1500 Max. 3000 L Ø1200 mm 139W Ø900 mm 13344 lm Ø600 mm
 Min. 1000 Max. 3000 Min. 1500 Max. 3000 M Ø1200 mm 108W Ø900 mm 10360 lm	 Min. 1000 Max. 3000 Min. 1500 Max. 3000 N Ø900 mm 76W Ø600 mm 7296 lm		

Kelvin

A 2400	V 2700	W 3000 [Standard]	X 4000
---------------	---------------	--------------------------	---------------

Power supply | Alimentación | Alimentation

OU On / Off — 100-240V	DU Dali — 100-240V
RU 0 - 10V — 100-240V	

Finishings | Acabados | Finitions

14 White - Blanco - Blanc	05 Black - Negro - Noir	EF Golden - Dorado - Doré

71-5961-00-00

Optional Casambi accessory on all models; only when RU and DA can be regulated. | Accesorio opcional Casambi en todos los modelos; solo cuando se puede regular RU y DA. | Accessoire Casambi en option sur tous les modèles; uniquement en cas de possibilité de réglage RU et DA.

Customise your product | Personaliza tu producto | Personnalisez votre produit

Reference example | Ejemplo de referencia | Exemple de référence

C	F	4	G	-	00	X	9	AZ	DU	05
			Ø3000 Ø2000 Ø1200			4000			DALI	Black Negro Noir

Product range Familia Famille	Light direction Dirección luz Direction de la lumière	Ceiling rose Florón Monture	Model Modelo Modèle	Guide Cuión Trait d'union	Power Potencia Puissance	Kelvin Kelvin Kelvin	CRI CRI CRI	Angle Ángulo Angle	Power supply Alimentación Alimentation	Finish Acabados Finition	
C	Inward Interior Intérieur	D	4 Ø600 A — 00 2400 A CRI >90 9 AZ ON / OFF OU White 14							Blanco	
			Ø900 K 2700 V DALI DU Black 05							Negro	
			Ø1200 B 3000 (Standard) W 0 - 10V RU Golden EF								Dorado
	Outward Exterior Extérieur	F	5*	Ø2000 C 4000 X							
				Ø3000 D Ø3000 G Ø2000 H Ø1200 L Ø1200 M Ø900 N Ø600							
				Ø2000 H Ø1200 L Ø600							
	Downwards Bajo Vers le bas	S		Ø3000 D Ø3000 G Ø2000 H Ø1200 L Ø1200 M Ø900 N Ø600							
				Ø2000 H Ø1200 L Ø600							
				Ø900 N Ø600							

* Can only be combined with the models A B C D. | Combinable solo con los modelos A B C D. | Combinable uniquement avec les modèles A, B, C et D.

Please contact our sales team further technical information. | Por favor, consulte a nuestro equipo de ventas para obtener más información técnica. | Veuillez consulter notre équipe commerciale pour plus d'informations techniques.

CIRCULAR



Light direction | Dirección de la luz | Direction de la lumière

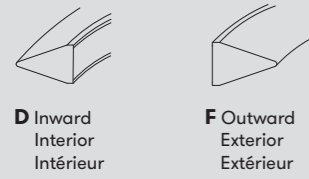

Ceiling rose | Tipo florón | Type de monture

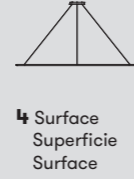

Model | Modelo | Modèle

 E Ø1200 mm 558W Ø2000 mm 46560 lm Ø3000 mm Ø2000 mm Ø1200 mm	 F Ø600 mm 328W Ø1200 mm 27360 lm Ø2000 mm Ø1200 mm Ø600 mm	 I Ø1200 mm 380W Ø2000 mm 31680 lm Ø2000 mm Ø1200 mm	 J Ø600 mm 207W Ø1200 mm 17280 lm Ø1200 mm Ø600 mm
 O Ø900 mm 210W Ø2000 mm 20160 lm Ø900 mm			

Kelvin

A 2400	V 2700	W 3000 (Standard)	X 4000
---------------	---------------	--------------------------	---------------

Power supply Alimentación Alimentation	Finishings Acabados Finitions
OU On / Off — 100-240V	DU Dali — 100-240V
RU 0 - 10V — 100-240V	14 White - Blanco - Blanc 05 Black - Negro - Noir EF Golden - Dorado - Doré

71-5961-00-00
 Optional Casambi accessory on all models; only when RU and DA can be regulated. | Accesorio opcional Casambi en todos los modelos; solo cuando se puede regular RU y DA. | Accessoire Casambi en option sur tous les modèles; uniquement en cas de possibilité de réglage RU et DA.

Customise your product | Personaliza tu producto | Personnalisez votre produit

Reference example | Ejemplo de referencia | Exemple de référence

C | **F** | **4** | **G** | **-** | **00** | **X** | **9** | **AZ** | **DU** | **05**

Ø3000
 Ø2000
 Ø1200

4000

DALI

Black
Negro
Noir

Product range Familia Famille	Light direction Dirección luz Direction de la lumière	Ceiling rose Florón Monture	Model Modelo Modèle	Guide Guión Trait d'union	Power Potencia Puissance	Kelvin Kelvin Kelvin	CRI CRI CRI	Angle Ángulo Angle	Power supply Alimentación Alimentation	Finish Acabados Finition	
C	Inward Interior Intérieur	D	Ø1200 E —	00		2400 A	CRI >90	9 AZ	ON / OFF OU	White 14	
			Ø2000			2700 V			DALI DU	Black 05	
			Ø3000			3000 W (Standard)			0 - 10V RU	Golden EF	
			Ø2000								
			Ø1200								
	Outward Exterior Extérieur	F	Ø600 F			4000 X					
			Ø1200								I
			Ø2000								J
			Ø1200								O
			Ø600								

Please contact our sales team further technical information. | Por favor, consulte a nuestro equipo de ventas para obtener más información técnica. | Veuillez consulter notre équipe commerciale pour plus d'informations techniques.

CIRCULAR



Light direction | Dirección de la luz | Direction de la lumière

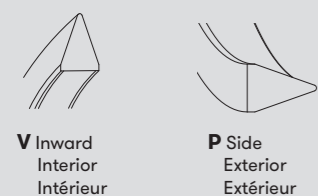

V Inward
Interior
Intérieur

P Side
Exterior
Extérieur

Ceiling rose | Tipo florón | Type de montage

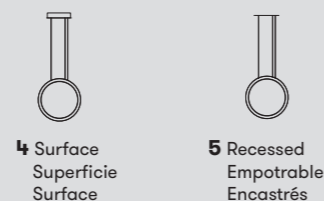

4 Surface
Superficie
Surface

5 Recessed
Empotrable
Encastrés

Model | Modelo | Modèle

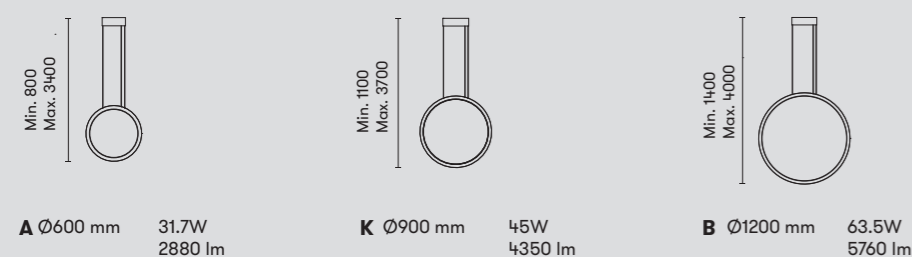

A Ø600 mm 31.7W
2880 lm

K Ø900 mm 45W
4350 lm

B Ø1200 mm 63.5W
5760 lm

Kelvin

A 2400 **V** 2700 **W** 3000 (Standard) **X** 4000

Power supply | Alimentación | Alimentation

OU On / Off — 100-240V

DU Dali — 100-240V

RU 0 - 10V — 100-240V

Finishings | Acabados | Finitions

14 White - Blanco - Blanc **05** Black - Negro - Noir **EF** Golden - Dorado - Doré

71-5961-00-00

Optional Casambi accessory on all models; only when RU and DA can be regulated. | Accesorio opcional Casambi en todos los modelos; solo cuando se puede regular RU y DA. | Accessoire Casambi en option sur tous les modèles; uniquement en cas de possibilité de réglage RU et DA.

Customise your product | Personaliza tu producto | Personnalisez votre produit

Reference example | Ejemplo de referencia | Exemple de référence



Product range Familia Famille	Light direction Dirección luz Direction de la lumière	Ceiling rose Florón Monture	Model Modelo Modèle	Guide Guión Trait d'union	Power Potencia Puissance	Kelvin Kelvin Kelvin	CRI CRI CRI	Angle Ángulo Angle	Power supply Alimentación Alimentation	Finish Acabados Finition
C	Inward Interior Intérieur	V	Ø600 A	—	00	2400 A	CRI >90	9 AZ	ON / OFF OU	White Blanco Blanc 14
			Ø900 K			2700 V			DALI DU	Black Negro Noir 05
	Side Exterior Extérieur	P	Ø1200 B			3000 W (Standard)			0 - 10V RU	Golden Dorado Doré EF
						4000 X				

Please contact our sales team further technical information. | Por favor, consulte a nuestro equipo de ventas para obtener más información técnica. | Veuillez consulter notre équipe commerciale pour plus d'informations techniques.

COCKTAIL

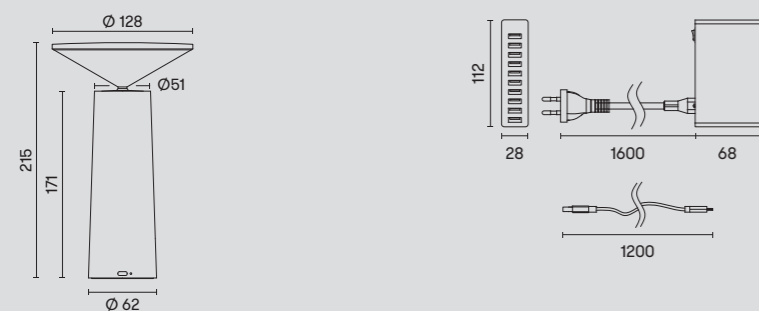

10-7063-14-14 (Touch dimming) 100-240V
 10-7063-05-05 (Touch dimming) 100-240V

LED 3W
 290 lm 3000K
 10-8327-14-14 (Touch dimming) 100-240V
 10-8327-05-05 (Touch dimming) 100-240V
 10-8327-EX-EX (Touch dimming) 100-240V

LED 3W
 237 lm 2700K

Multiple Charger | Cargador múltiple |
 Chargeur multiple
 71-7579-05-00 - 100-240V
 10 positions
 50W

Finishings | Acabados | Finitions

14 White | Blanco | Blanc

05 Black | Negro | Noir

EX Olive Grey | Gris Oliva |
 Gris olive

Materials | Materiales | Matériaux

AL Aluminium | Aluminio | Aluminium

PC Diffuser material polycarbonate |

DIF Material difusor policarbonato |
 Matériau diffusant polycarbonate



Touch dimmer
 25% - 50% - 75% -
 100% - Off

Battery - Batería - Batterie
 100% - 10h | 75% - 12h
 50% - 18h | 25% - 30h

Rotation movement 360°
 Movimiento rotación 360°
 Mouvement de rotation 360°

DEW

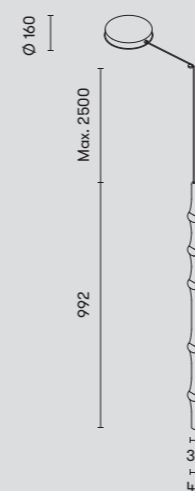

00-8304-05-M1 (DALI) 180-277V
 00-8305-05-M1 (0-10V) 180-277V

LED SAMSUNG 10W A++ A
 782 lm 2700K

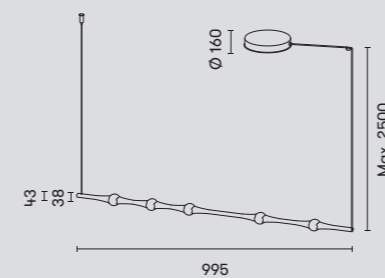

00-8302-05-M1 (DALI) 180-277V
 00-8303-05-M1 (0-10V) 180-277V

LED SAMSUNG 10W A++ A
 782 lm 2700K

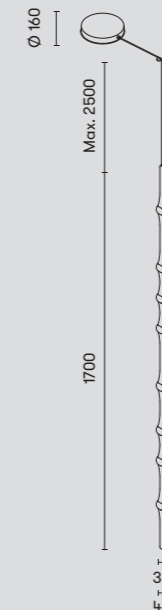

00-8306-05-M1 (DALI) 180-277V
 00-8307-05-M1 (0-10V) 180-277V

LED SAMSUNG 17W A++ A
 1383 lm 2700K

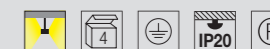
Finishings | Acabados | Finitions

05 Black | Negro | Noir

Materials | Materiales | Matériaux

AL Aluminium | Aluminio | Aluminium

PC Diffuser material polycarbonate |

DIF Material difusor policarbonato |
 Matériau diffusant polycarbonate

ELY

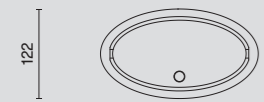
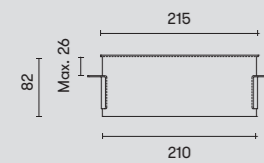

05-7563-14-M1* (Touch dimming) 100-240V

LED 8.4W A++ A
485 lm 3000K

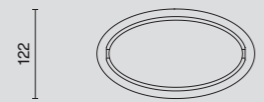
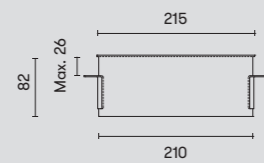

05-7564-14-M1** (On-Off) 100-240V

LED 8.4W A++ A
485 lm 3000K



Finishings | Acabados | Finitions

- 14 White | Blanco | Blanc
- 21 Chrome | Cromo | Chrome
- DO Matt gold | Dorado mate | Doré mat

Materials | Materiales | Matériaux

- ST Steel | Acero | Acier
- AL Aluminium | Aluminio | Aluminium
- PVC Shade material | Material pantalla
SHADE PVC | Matériels abat-jour PVC

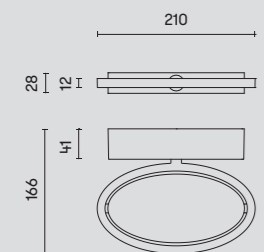

05-7562-14-M1** (On-Off) 220-240V

LED 10.6W A++ A
665 lm 3000K

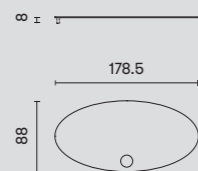

* 71-7563-21-21
* 71-7563-DO-DO

Optional accessory | Accesorio opcional |
Accessoire en option

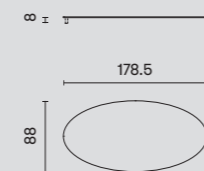

** 71-7564-21-21
** 71-7564-DO-DO

Optional accessory | Accesorio opcional |
Accessoire en option

FLAVIA

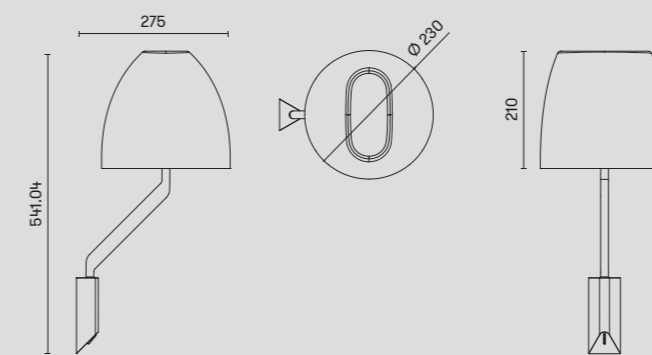

05-3686-21-M1

1 x E-27 Max. 18W A++ C
Max. L=125mm Ø=78mm
Fluorescent - LED



Finishings | Acabados | Finitions

- 21 Chrome | Cromo | Chrome

Materials | Materiales | Matériaux

- ZAMAK Zamak | Zamak | Zamak
- PMMA Shade material PMMA | Material pantalla
SHADE PMMA | Matériels abat-jour PMMA

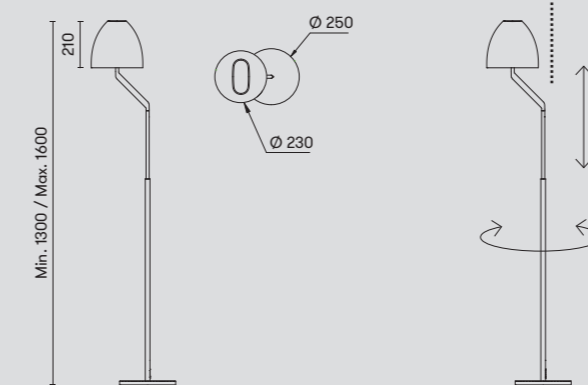

25-3686-21-M1

1 x E-27 Max. 18W A++ C
Max. L=125mm Ø=78mm
Fluorescent - LED



Finishings | Acabados | Finitions

- 21 Chrome | Cromo | Chrome

Materials | Materiales | Matériaux

- ZAMAK Zamak | Zamak | Zamak
- PMMA Shade material PMMA | Material pantalla
SHADE PMMA | Matériels abat-jour PMMA



1-Step

Choose the structure in the finish that best suits you. | Elige la estructura en el acabado que más te guste. | Choisissez la structure dans la finition que vous préférez.

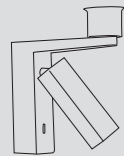

+

2-Step

Select the shape, size and finish of the shade. You can see our recommendations on the following pages. | Elige la forma, tamaño y acabado de la pantalla. Verás nuestras recomendaciones en las páginas siguientes. | Choisissez la forme, la dimension et la finition de l'abat-jour. Vous trouverez nos recommandations dans les pages suivantes.

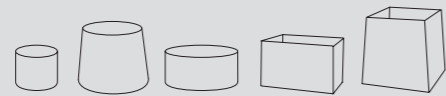

=

3-Step

Your lamp is now ready! | Tu lámpara está lista! | Votre lampe est prête!



**Round shades
Pantallas redondas
Abat-jour ronds**



Finishings | Acabados | Finitions

- 14** White | Blanco | Blanc
- BY** Beige | Beige | Beige
- AJ** Opera grey | Gris ópera | Gris ópera

**Squared shades
Pantallas cuadradas
Abat-jour carrés**

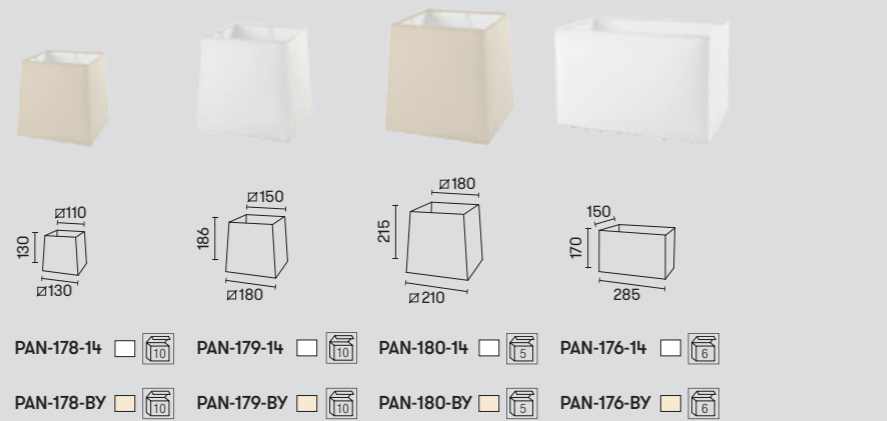

Finishings | Acabados | Finitions

- 14** White | Blanco | Blanc
- BY** Beige | Beige | Beige

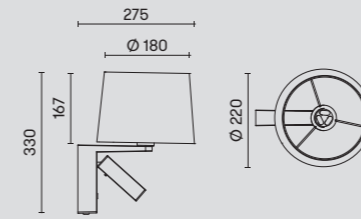

05-1941-BW-82 + PAN
05-1941-81-82 + PAN
 100-240V

1 x E-27 Max. 60W
 Max. L=130mm Ø=60mm
 Halogen - Fluorescent - LED
 LED CREE 3W A++ C
 162 lm 3000K



Finishings | Acabados | Finitions

- BW** Matt white | Blanco mate | Blanc mate
- 81** Satin nickel | Níquel satinado | Nickel satiné

Materials | Materiales | Matériaux

- AL** Aluminium | Aluminio | Aluminium
- TEXTIL SHADE** Shade material fabric | Material pantalla tela | Matériels abat-jour tissu

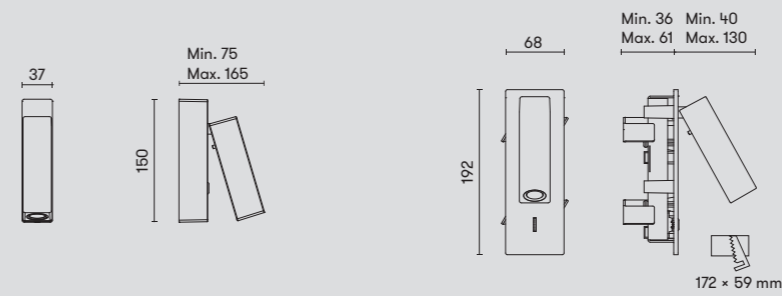

05-1940-BW-BW
05-1940-81-81
 100-240V

LED CREE 3W A++ C
 162 lm 3000K

05-4787-BW-BW
05-4787-81-81
 100-240V

LED CREE 3W A++ C
 162 lm 3000K



Finishings | Acabados | Finitions

- BW** Matt white | Blanco mate | Blanc mate
- 81** Satin nickel | Níquel satinado | Nickel satiné

Materials | Materiales | Matériaux

- AL** Aluminium | Aluminio | Aluminium
- ZAMAK** Zamak | Zamak | Zamak

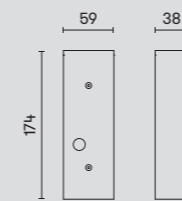

71-4787-AV-AV

Recessing kit for brick wall
 Kit para empotrar en pared de obra
 Kit pour encastrer au mur



HALL

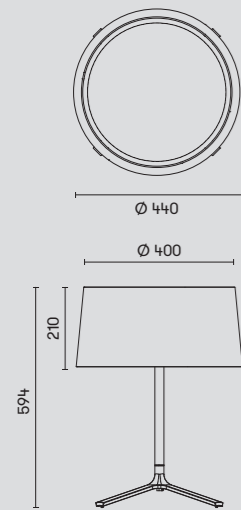

10-1940-05-H13W ■
10-1940-BW-T007 □

3 × E-27 Max. 18W A++ C
Max. L=146mm Ø=52mm
Fluorescent - LED



Top diffuser | Difusor Superior | Diffuseur Supérieur



Finishings | Acabados | Finitions

■ **BW** Matt white | Blanco mate | Blanc mate + ■ **T007** White | Blanco | Blanc

■ **05** Black | Negro | Noir + ■ **H13W** Black | Negro | Noir

Materials | Materiales | Matériaux

■ **ST** Steel | Acero | Acier

■ **TEXTIL** Shade material fabric | Material pantalla tela |
■ **SHADE** Matériels abat-jour tissu

■ **PMMA** Diffuser material PMMA | Material difusor
■ **DIF** PMMA | Matériau diffusant PMMA



HELLO

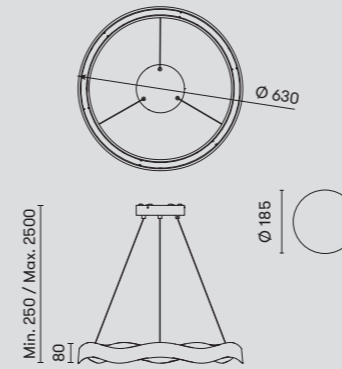

00-5275-BW-M1 □ (Mains dimming)*
00-5275-CT-M1 ■ (Mains dimming)*
220-240V

LED 24.3W A++ A
2300 lm 2700K



Finishings | Acabados | Finitions

■ **BW** Matt white | Blanco mate | Blanc mate

■ **CT** Wood brown | Marrón madera | Bois marron

Materials | Materiales | Matériaux

■ **PUR** Polyurethane | Poliuretano | Polyuréthane

■ **PMMA** Diffuser material PMMA | Material difusor
■ **DIF** PMMA | Matériau diffusant PMMA

* Dimmers compatible at
www.leds.c-4.com (Products & Downloads)

* Compatibilidad con reguladores corte de fase en
www.leds.c-4.com (Productos & Descargas)

* Compatible avec des variateurs en coupure de phase que vous pouvez consulter www.leds.c-4.com (Produits & Téléchargements)

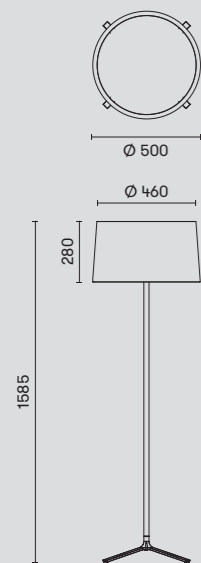

25-1940-05-H13W ■
25-1940-BW-T007 □

3 × E-27 Max. 30W A++ C
Max. L=176mm Ø=60mm
Fluorescent - LED



Top diffuser | Difusor Superior | Diffuseur Supérieur



Finishings | Acabados | Finitions

■ **05** Black | Negro | Noir + ■ **H13W** Black | Negro | Noir

■ **BW** Matt white | Blanco mate | Blanc mate + ■ **T007** White | Blanco | Blanc

Materials | Materiales | Matériaux

■ **ST** Steel | Acero | Acier

■ **TEXTIL** Shade material fabric | Material pantalla tela |
■ **SHADE** Matériels abat-jour tissu

■ **PMMA** Diffuser material PMMA | Material difusor
■ **DIF** PMMA | Matériau diffusant PMMA

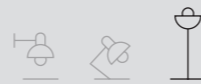

ILARGI

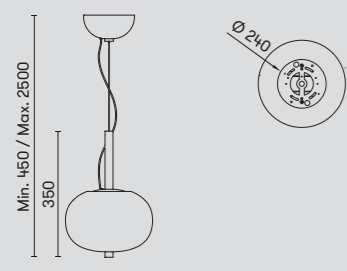

- 00-6010-92-F9 ■ (1-10V) 120-277V
- 00-6010-93-F9 ■ (1-10V) 120-277V
- 00-6452-92-F9 ■ (Phase Cut) 220-240V
- 00-6452-93-F9 ■ (Phase Cut) 220-240V
- 00-6454-92-F9 ■ (Dali) 220-240V
- 00-6454-93-F9 ■ (Dali) 220-240V

LED 8.5W
800 lm 2700K

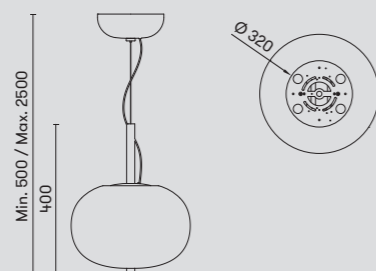

- 00-6011-92-F9 ■ (1-10V) 120-277V
- 00-6011-93-F9 ■ (1-10V) 120-277V
- 00-6455-92-F9 ■ (Phase Cut) 220-240V
- 00-6455-93-F9 ■ (Phase Cut) 220-240V
- 00-6457-92-F9 ■ (Dali) 220-240V
- 00-6457-93-F9 ■ (Dali) 220-240V

LED 14.8W
1315 lm 2700K

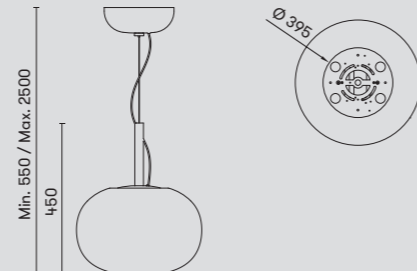

- 00-6012-92-F9 ■ (1-10V) 100-240V
- 00-6012-93-F9 ■ (1-10V) 100-240V
- 00-6458-92-F9 ■ (Phase Cut) 220-240V
- 00-6458-93-F9 ■ (Phase Cut) 220-240V
- 00-6460-92-F9 ■ (Dali) 220-240V
- 00-6460-93-F9 ■ (Dali) 220-240V

LED 21.4W
1880 lm 2700K



Finishings | Acabados | Finitions

- 92 Fresno dark | Fresno oscuro | Frêne foncé
- 93 Fresno light | Fresno claro | Frêne clair

Materials | Materiales | Matériaux

- WOOD Wood | Madera | Bois
- ST Steel | Acero | Acier
- GLASS OPAL3 Diffuser material triplex opal glass | Material difusor cristal opal triplex | Matériau diffusant verre opal triplex
- DIF

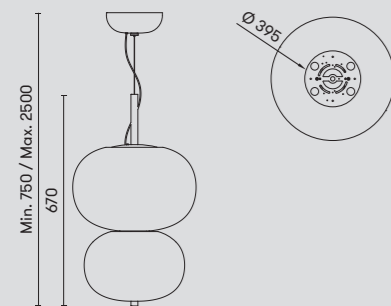

- 00-6013-92-F9 ■ (1-10V) 100-240V
- 00-6013-93-F9 ■ (1-10V) 100-240V
- 00-6461-92-F9 ■ (Phase Cut) 220-240V
- 00-6461-93-F9 ■ (Phase Cut) 220-240V
- 00-6463-92-F9 ■ (Dali) 100-277V
- 00-6463-93-F9 ■ (Dali) 100-277V

LED 36.1W
3195 lm 2700K

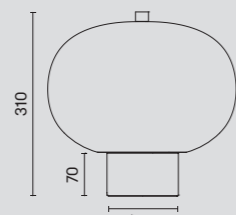
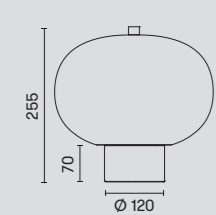
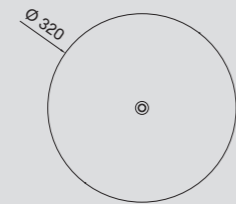
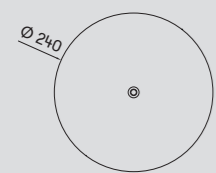

- 10-6010-92-F9 ■ (Touch dimming) 100-240V
- 10-6010-93-F9 ■ (Touch dimming) 100-240V

LED 8.5W
800 lm 2700K

- 10-6011-92-F9 ■ (Touch dimming) 100-240V
- 10-6011-93-F9 ■ (Touch dimming) 100-240V

LED 14.8W
1315 lm 2700K



Finishings | Acabados | Finitions

- 92 Fresno dark | Fresno oscuro | Frêne foncé
- 93 Fresno light | Fresno claro | Frêne clair

Materials | Materiales | Matériaux

- WOOD Wood | Madera | Bois
- GLASS OPAL3 Diffuser material triplex Opal glass | Material difusor cristal opal triplex | Matériau diffusant verre opal triplex
- DIF

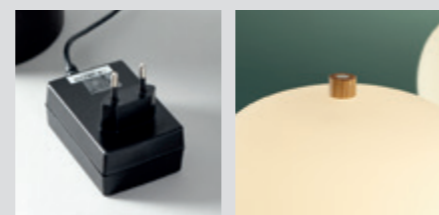

Touch dimmer

INVISIBLE

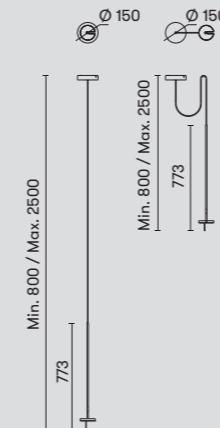

- 00-5693-05-05 ■ (Mains dimming)* 220-240V | 3000K
- 00-7382-05-05 ■ (Mains dimming)* 220-240V | 2700K

LED 9W A++ A
765 lm

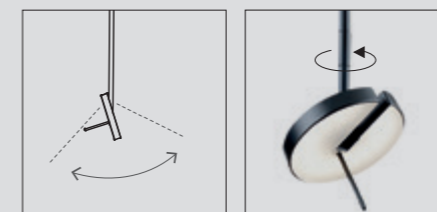

* Dimmers compatible at www.leds.c-4.com (Products & Downloads)

* Compatibilidad con reguladores corte de fase en www.leds.c-4.com (Productos & Descargas)

* Compatible avec des variateurs en coupure de phase que vous pouvez consulter www.leds.c-4.com (Produits & Téléchargements)

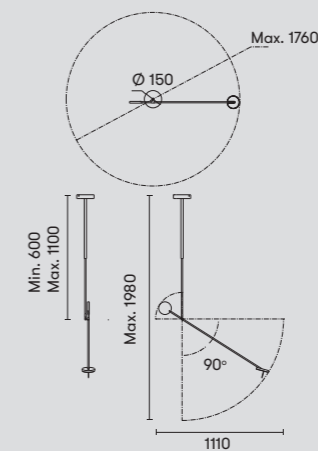

- 00-5694-05-05 ■ (Mains dimming)* 220-240V | 3000K
- 00-7383-05-05 ■ (Mains dimming)* 220-240V | 2700K

LED 9W A++ A
765 lm

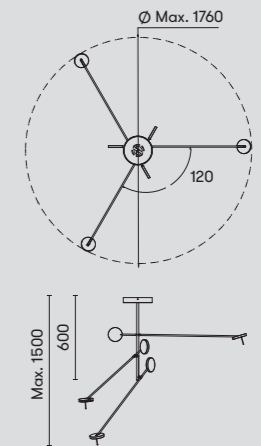

- 00-5695-05-05 ■ (Standard) 100-240V | 3000K
- 00-5696-05-05 ■ (Mains dimming)* 220-240V | 3000K
- 00-7384-05-05 ■ (Standard) 100-240V | 2700K
- 00-7385-05-05 ■ (Mains dimming)* 220-240V | 2700K

LED 27W A++ A
2295 lm



Finishings | Acabados | Finitions

- 05 Black | Negro | Noir

Materials | Materiales | Matériaux

- ST Steel | Acero | Acier
- PMMA Diffuser material PMMA | Material difusor PMMA | Matériau diffusant PMMA
- DIF

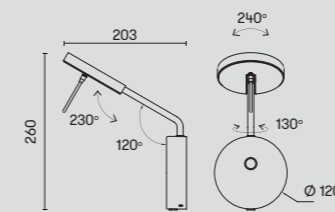

- 05-7380-05-05 ■ (Touch dimming) 100-240V | 3000K
- 05-7382-05-05 ■ (Touch dimming) 100-240V | 2700K

LED 9W A++ A
765 lm

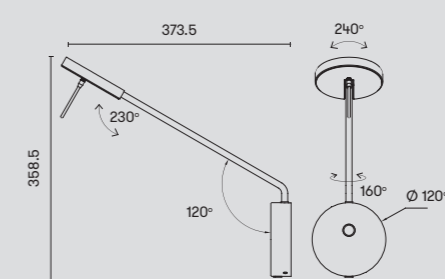

- 05-7381-05-05 ■ (Touch dimming) 100-240V | 3000K
- 05-7383-05-05 ■ (Touch dimming) 100-240V | 2700K

LED 9W A++ A
765 lm



Finishings | Acabados | Finitions

- 05 Black | Negro | Noir

Materials | Materiales | Matériaux

- AL Aluminium | Aluminio | Aluminium
- ST Steel | Acero | Acier
- PMMA Diffuser material PMMA | Material difusor PMMA | Matériau diffusant PMMA
- DIF

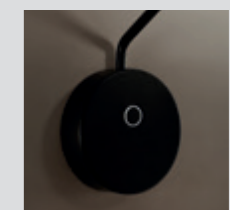

Touch dimmer

INVISIBLE

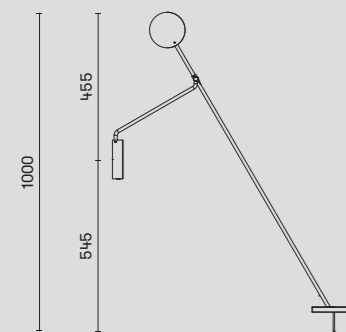

05-5693-05-05 ■ (Touch dimming)
100-240V | 3000K
05-7385-05-05 ■ (Touch dimming)
100-240V | 2700K

LED 9W A++ A
765 lm

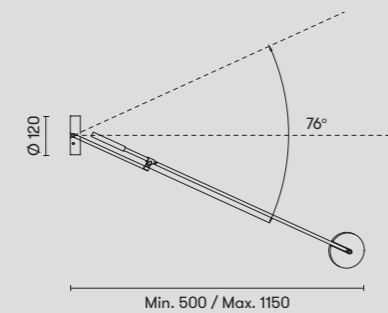
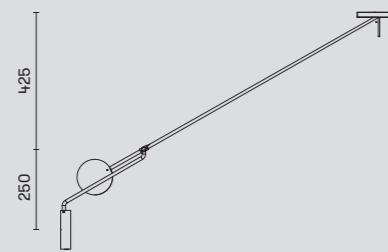

Min. 500 / Max. 1150

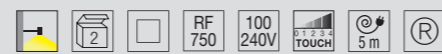
**Finishings | Acabados | Finitions**

■ **05** Black | Negro | Noir

Materials | Materiales | Matériaux

AL Aluminium | Aluminio | Aluminium

PMMA Diffuser material PMMA | Material difusor PMMA | Matériau diffusant PMMA

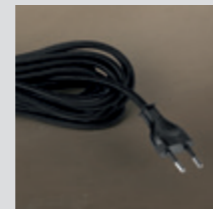

5 m.

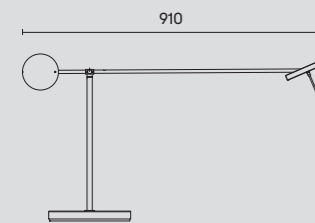

10-5693-05-05 ■ (Touch dimming)
100-240V | 3000K
10-7385-05-05 ■ (Touch dimming)
100-240V | 2700K

LED 9W
765 lm

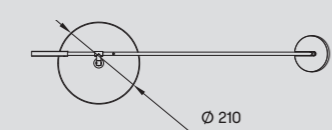
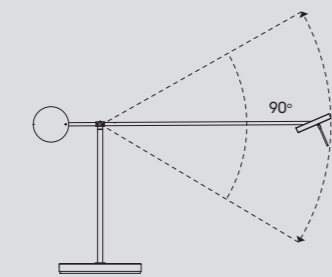

Ø 210

**Finishings | Acabados | Finitions**

■ **05** Black | Negro | Noir

Materials | Materiales | Matériaux

ST Steel | Acero | Acier

PMMA Diffuser material PMMA | Material difusor PMMA | Matériau diffusant PMMA

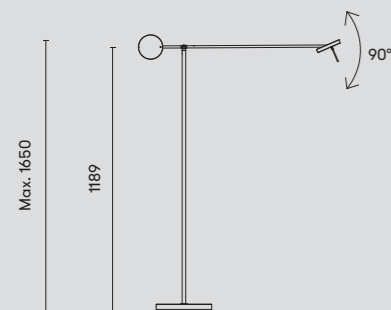

25-5693-05-05V1 ■
100-240V | 3000K
25-7385-05-05 ■
100-240V | 2700K

LED 9W
765 lm

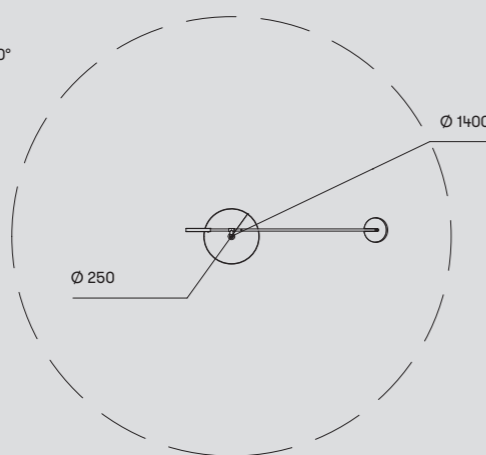

Ø 250

Ø 1400

**Finishings | Acabados | Finitions**

■ **05** Black | Negro | Noir

Materials | Materiales | Matériaux

ST Steel | Acero | Acier

PMMA Diffuser material PMMA | Material difusor PMMA | Matériau diffusant PMMA

NET

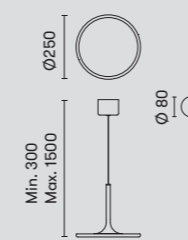

00-3685-BW-M1 ■
100-240V

LED 15W A++ A
1440 lm 3000K



71-2241-00-00

Controller with remote control for 00-0003 |
Controlador con mando a distancia para 00-0003 |
Contrôleur avec télécommande pour 00-0003



Dimmer | Regulador de intensidad |
Régulateur d'intensité



Batteries included | Pilas incluidas | Piles
fournies

**Finishings | Acabados | Finitions**

■ **BW** Matt white | Blanco mate | Blanc mate

Materials | Materiales | Matériaux

AL Aluminium | Aluminio | Aluminium

PS Diffuser material polystyrene | Material difusor poliestireno | Matériau diffusant polystyrène



PREMIUM

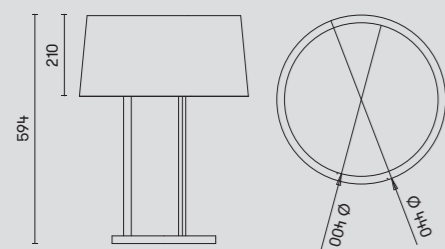

10-5076-06-H13W
10-5076-01-H13W

3 × E-27 Max. 18W A++ C
Max. L=140mm Ø=52mm
Fluorescent - LED



Top diffuser | Difusor Superior | Diffuseur Supérieur



Finishings | Acabados | Finitions

06 Copper | Cobre | Cuivre + **H13W** Black | Negro | Noir

01 Gold plating | Oro electrolítico | Dorure à l'or par électrolyse + **H13W** Black | Negro | Noir

Materials | Materiales | Matériaux

ST Steel | Acero | Acier

TEXTIL SHADE Shade material fabric | Material pantalla tela | Matériels abat-jour tissu

PMMA DIF Diffuser material PMMA | Material difusor PMMA | Matériau diffusant PMMA



PRIME

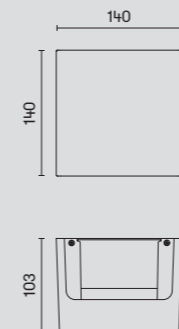

05-5956-BW-BW
05-5956-Z5-Z5 (Mains dimming)*
220-240V

LED 40W A++ A
4000 lm 3000K



Finishings | Acabados | Finitions

BW Matt white | Blanco mate | Blanc mate

Z5 Anthracite grey | Gris antracita | Gris anthracite

Materials | Materiales | Matériaux

AL Aluminium | Aluminio | Aluminium

* Dimmers compatible at www.leds-c4.com (Products & Downloads)

* Compatibilidad con reguladores corte de fase en www.leds-c4.com (Productos & Descargas)

* Compatible avec des variateurs en coupure de phase que vous pouvez consulter www.leds-c4.com (Produits & Téléchargements)

RINGOFIRE

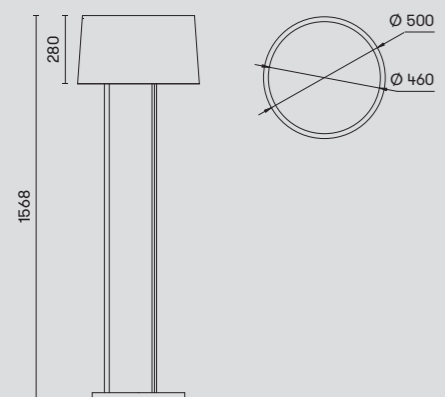

25-5076-06-H13W
25-5076-01-H13W

3 × E-27 Max. 30W A++ C
Max. L=176mm Ø=60mm
Fluorescent - LED

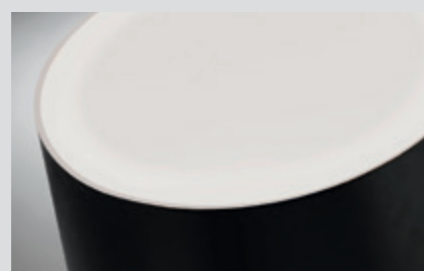

Top diffuser | Difusor Superior | Diffuseur Supérieur



Finishings | Acabados | Finitions

06 Copper | Cobre | Cuivre + **H13W** Black | Negro | Noir

01 Gold plating | Oro electrolítico | Dorure à l'or par électrolyse + **H13W** Black | Negro | Noir

Materials | Materiales | Matériaux

ST Steel | Acero | Acier

TEXTIL SHADE Shade material fabric | Material pantalla tela | Matériels abat-jour tissu

PMMA DIF Diffuser material PMMA | Material difusor PMMA | Matériau diffusant PMMA

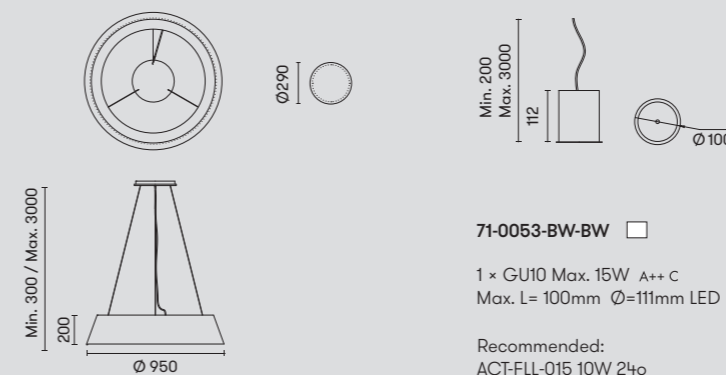

00-0054-05-BW
100-240V

LED 41W A++ A
1536 lm 3000K



Finishings | Acabados | Finitions

05 Black | Negro | Noir

BW White | Blanco | Blanc

Materials | Materiales | Matériaux

ST Steel | Acero | Acier

PUR Polyurethane | Poliuretano | Polyuréthane



Independent double lighting system | Sistema de doble iluminación independiente | Système double éclairage indépendant

SATURN

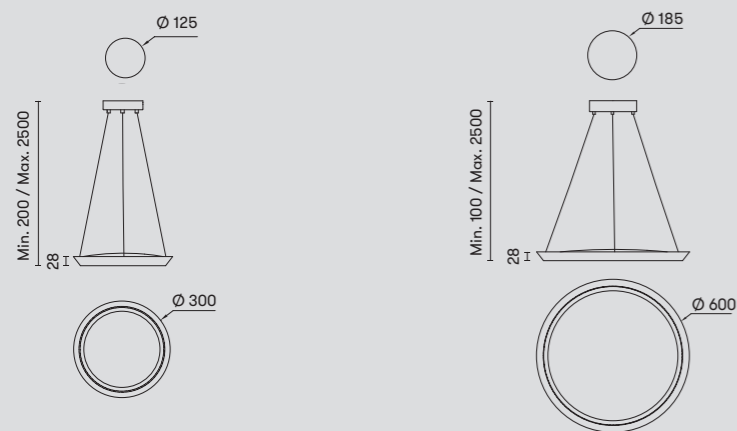

00-6015-27-M1 (Mains dimming)*
220-240V

LED 13W A++ A
1300 lm 2700K

00-6014-27-M1 (Mains dimming)*
220-240V

LED 40W A++ A
4000 lm 2700K



Finishings | Acabados | Finitions

27 Matt satin finished brass | Latón satinado mate | Laiton satiné mat

Materials | Materiales | Matériaux

ST Steel | Acero | Acier

PS Diffuser material polystyrene | Material difusor poliestireno | Matériau diffusant polystyrène

* Dimmers compatible at www.leds.c4.com (Products & Downloads)

* Compatibilidad con reguladores corte de fase en www.leds.c4.com (Productos & Descargas)

* Compatible avec des variateurs en coupure de phase que vous pouvez consulter www.leds.c4.com (Produits & Téléchargements)

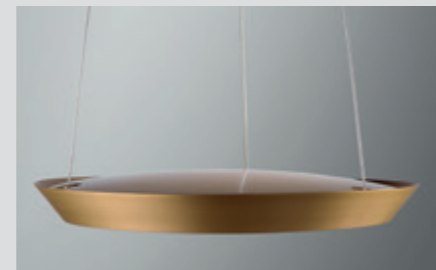

SHOEMAKER



00-7727-05-EK (Dali)
00-7727-05-EQ (Dali)
100-240V

LED CREE 25W A++ A
Turnable White
1790 lm 2700K - 6500K

00-7728-05-EK (0-10V)
00-7728-05-EQ (0-10V)
00-7731-05-EK (Dali)
00-7731-05-EQ (Dali)
100-240V

LED CREE 25W A++ A
1790 lm 2700K

00-7729-05-EK (Dali)
00-7729-05-EQ (Dali)
100-240V

LED SAMSUNG 50W A++ A
Turnable White
4002 lm 2700K - 6500K

00-7730-05-EK (0-10V)
00-7730-05-EQ (0-10V)
00-7732-05-EK (Dali)
00-7732-05-EQ (Dali)
100-240V

LED SAMSUNG 50W A++ A
3631 lm 2700K

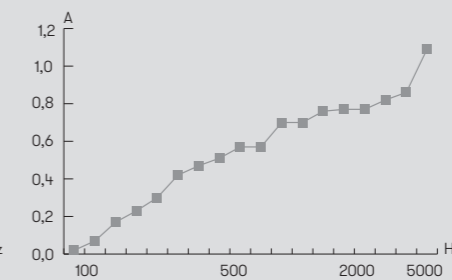
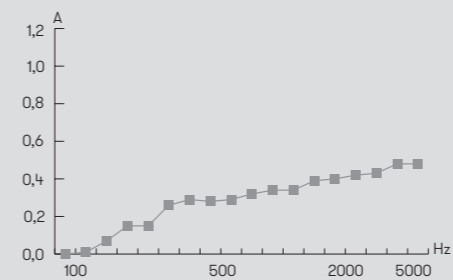

Sound absorption in a reverberatory chamber according to UNE-EN ISO 354:2004
Absorción acústica en cámara reverberante según UNE-EN ISO 354:2004
Absorption acoustique en chambre réverbérante conformément à UNE-EN ISO 354:2004



Finishings | Acabados | Finitions

05 Black | Negro | Noir

Materials | Materiales | Matériaux

ST Steel | Acero | Acier

PMMA PMMA | PMMA | PMMA

FELT Shade material felt | Material pantalla fieltro | Matériels abat-jour fielt

SKATA

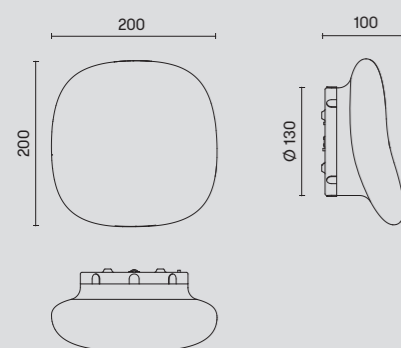

05-4750-14-F9
100-240V

LED 4.3W A++ A
413 lm 3000K

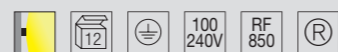
Finishings | Acabados | Finitions

14 White | Blanco | Blanc

Materials | Materiales | Matériaux

ST Steel | Acero | Acier

GLASS OPAL 3 DIF Diffuser material triplex Opal glass |
Material difusor cristal opal triplex |
Materiau diffusant verre opal triplex



Its special design allows for multiple combinations. |
Su especial diseño permite múltiples combinaciones. |
Son design spécial permet de nombreuses
combinaisons.

Connection scheme. |
Esquema de conexión. |
Schéma de connexion.

TUBS

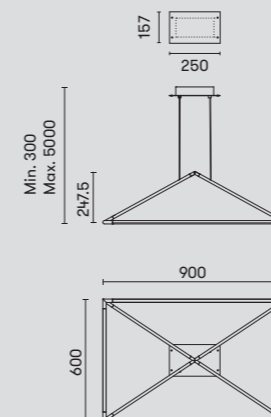

00-5999-05-M1 (On-Off)
00-6001-05-M1 (Dimmable DALI)
100-240V

LED 36W A++ A
3900 lm 3000K

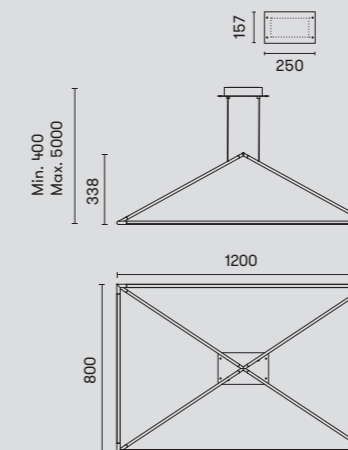

00-6000-05-M1 (On-Off)
00-6002-05-M1 (Dimmable DALI)
100-240V

LED 48W A++ A
5200 lm 3000K

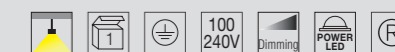
Finishings | Acabados | Finitions

05 Black | Negro | Noir

Materials | Materiales | Matériaux

AL Aluminium | Aluminio | Aluminium

PMMA DIF Diffuser material PMMA | Material difusor
PMMA | Materiau diffusant PMMA

Please contact our sales team further technical
information | Por favor, consulte a nuestro equipo
de ventas para obtener más información técnica |
Veuillez consulter notre équipe commerciale pour
plus d'informations techniques.

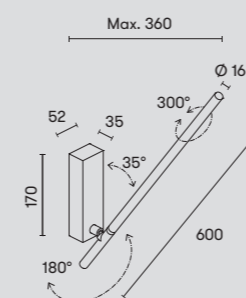

05-8102-05-M1 220-240V (On-Off)
05-8103-05-M1 220-240V (DALI)
05-8104-05-M1 120-240 (0-10V)

LED 11.5W A++ A
1245 lm 3000K

Finishings | Acabados | Finitions

05 Black | Negro | Noir

Materials | Materiales | Matériaux

AL Aluminium | Aluminio | Aluminium

ST Steel | Acero | Acier

PMMA DIF Diffuser material PMMA | Material difusor
PMMA | Materiau diffusant PMMA

TUBS

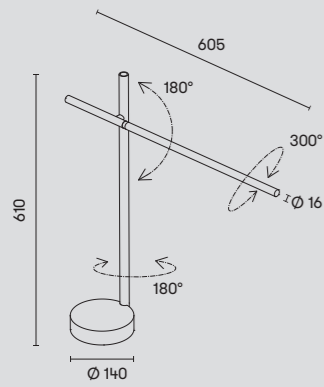

Touch dimmer

10-8102-05-M1 ■ (Touch dimming)
100-240V
LED 10.5W A++ A
1134 lm 3000K



Finishings | Acabados | Finitions

■ **05** Black | Negro | Noir

Materials | Materiales | Matériaux

AL Aluminium | Aluminio | Aluminium

MRBL Marble | Mármol | Marbre

ST Steel | Acero | Acier

PMMA ■ DIF Diffuser material PMMA | Material difusor PMMA | Matériau diffusant PMMA

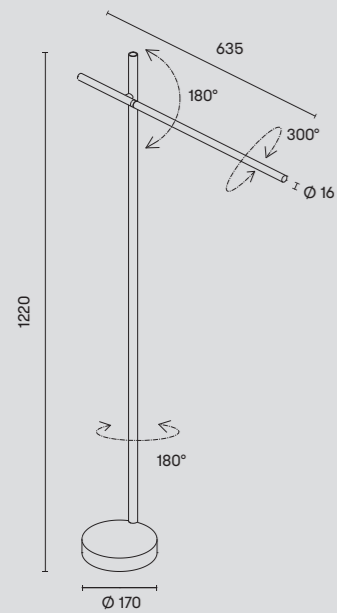

Touch dimmer

25-8102-05-M1 ■ (Touch dimming)
100-240V
LED 10.5W A++ A
1134 lm 3000K



Finishings | Acabados | Finitions

■ **05** Black | Negro | Noir

Materials | Materiales | Matériaux

AL Aluminium | Aluminio | Aluminium

MRBL Marble | Mármol | Marbre

ST Steel | Acero | Acier

PMMA ■ DIF Diffuser material PMMA | Material difusor PMMA | Matériau diffusant PMMA

TUBS MODULAR

LIGHT BULBS - TUBOS DE LUZ - TUBES LUMINEUX

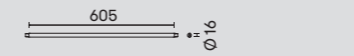

71-8247-05-M1 ■
LED 15.1W A++ A
1620 lm 3000K

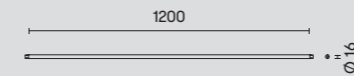

71-8249-05-M1 ■
LED 30W A++ A
3240 lm 3000K

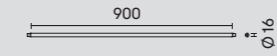

71-8248-05-M1 ■
LED 22.5W A++ A
2430 lm 3000K

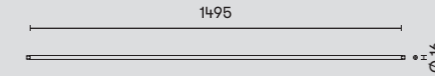

71-8250-05-M1 ■
LED 37W A++ A
3990 lm 3000K



Finishings | Acabados | Finitions

■ **05** Black | Negro | Noir

Materials | Materiales | Matériaux

AL Aluminium | Aluminio | Aluminium

PMMA ■ DIF Diffuser material PMMA | Material difusor PMMA | Matériau diffusant PMMA

BULB BASE - FLORÓN - BASE D'ALIMENTATION

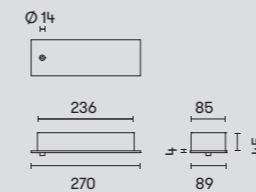

71-8265-05-05 ■ 176-305V
Max. 105W

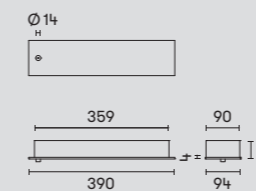

71-8267-05-05 ■ 100-305V (DALI)
Max. 180W

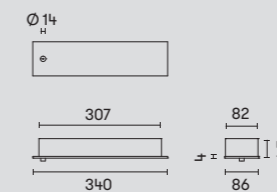

71-8266-05-05 ■ 100-305V (DALI)
Max. 105W

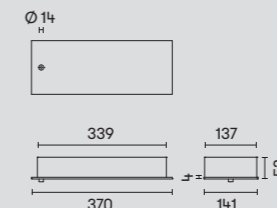

71-8268-05-05 ■ 90-305V (DALI)
Max. 320W

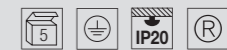

Finishings | Acabados | Finitions

■ **05** Black | Negro | Noir

Materials | Materiales | Matériaux

ST Steel | Acero | Acier

POWER SUPPLY UNIT WITH SOCKET - CAJA DE ALIMENTACIÓN CON TOMA DE CORRIENTE - BOÎTIER D'ALIMENTATION AVEC PRISE DE COURANT

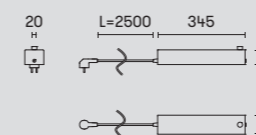

71-8287-05-05 ■
(Potentiometer | Potenciómetro | Potentiomètre)
Max. 105W



Finishings | Acabados | Finitions

■ **05** Black | Negro | Noir

Materials | Materiales | Matériaux

ST Steel | Acero | Acier

TUBS MODULAR

POWER INPUT CONNECTORS - CONECTORES DE ENTRADA DE CORRIENTE - CONNECTEURS D'ENTRÉE DE COURANT

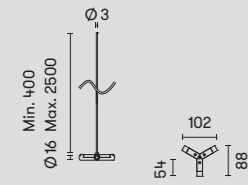

71-8251-05-05 ■
Y connector | Conector Y | Connecteur Y

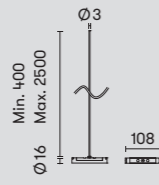

71-8252-05-05 ■
Linear connector with central input | Conector lineal con entrada central | Connecteur linéaire avec entrée centrale

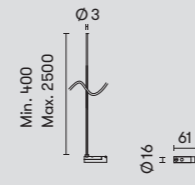

71-8256-05-05 ■
Linear connector with lateral input | Conector lineal con entrada lateral | Connecteur linéaire avec entrée latérale

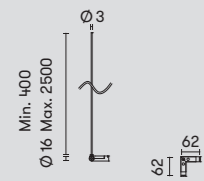

71-8254-05-05 ■
90° horizontal connector | Conector 90° horizontal | Connecteur 90° horizontal

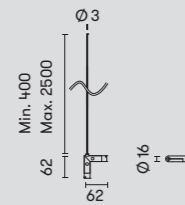

71-8255-05-05 ■
90° vertical connector | Conector 90° vertical | Connecteur 90° vertical

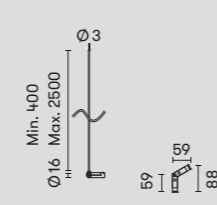

71-8253-05-05 ■
120° connector | Conector 120° | Connecteur 120°

CONTINUITY CONNECTORS - CONECTORES DE CONTINUIDAD - CONNECTEURS DE CONTINUITÉ

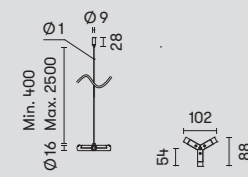

71-8257-05-05 ■
Y connector | Conector Y | Connecteur Y

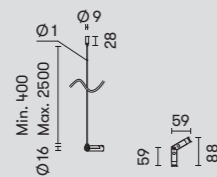

71-8258-05-05 ■
120° connector | Conector 120° horizontal | Connecteur 120°

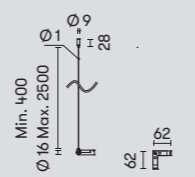

71-8259-05-05 ■
90° horizontal connector | Conector 90° horizontal | Connecteur 90° horizontal

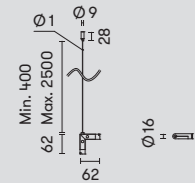

71-8260-05-05 ■
90° vertical connector | Conector 90° vertical | Connecteur 90° vertical

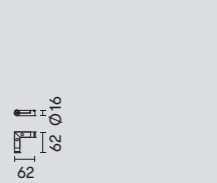

71-8261-05-05 ■
90° connector without wire | Conector 90° sin cable | Connecteur 90° sans câble

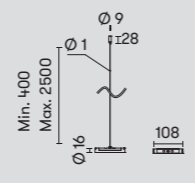

71-8262-05-05 ■
Linear connector | Conector lineal | Connecteur linéaire



Finishings | Acabados | Finitions
05 Black | Negro | Noir

Materials | Materiales | Matériaux
AL Aluminium | Aluminio | Aluminium

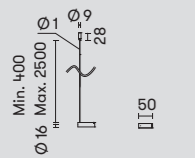

71-8263-05-05 ■
Linear end connector | Conector lineal final | Connecteur linéaire fina

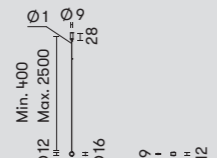

71-8264-05-05 ■
Inter-structure joint fitting
Accesorio de unión entre estructuras
Accessoire de raccord entre structures

WALL AND CEILING ATTACHMENT CLIP - CLIP DE FIJACIÓN PARA PARED Y TECHO - CLIP DE FIXATION MURALE ET PLAFOND

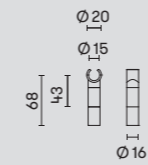

71-8286-05-05 ■



Finishings | Acabados | Finitions
05 Black | Negro | Noir

Materials | Materiales | Matériaux
ST Steel | Acero | Acier
ABS ABS | ABS | ABS

STANDARD COMBINATIONS - COMBINACIONES ESTÁNDAR - COMBINAISONS STANDARD

For more standard combinations, consult our configurator at grolighting.com. Consult our commercial team for custom combinations. Para más combinaciones estándares consultar configurador en grolighting.com. Consultar equipo comercial para combinaciones a medida. Pour plus de combinaisons standard, consulter le configurateur sur grolighting.com. Consulter l'équipe commerciale pour des combinaisons sur mesure.

PENDANT - SUSPENSIÓN - SUSPENSION

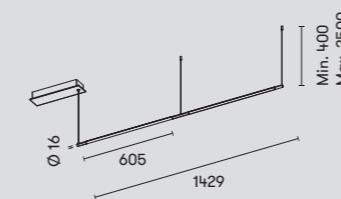

00-8248-05-M1 ■ 100-305V (DALI)
00-8292-05-M1 ■ 176-305V

LED 30.5W A++ A
1125 lm 3000K

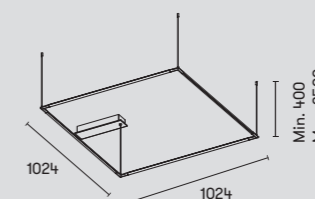

00-8256-05-M1 ■ 100-305V (DALI)
00-8294-05-M1 ■ 176-305V

LED 90W A++ A
3374 lm 3000K

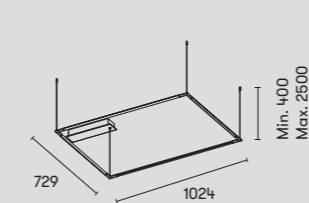

00-8259-05-M1 ■ 100-305V (DALI)
00-8295-05-M1 ■ 176-305V

LED 75.5W A++ A
2811 lm 3000K

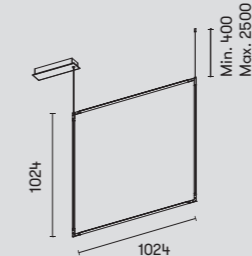

00-8266-05-M1 ■ 100-305V (DALI)
00-8297-05-M1 ■ 176-305V

LED 90W A++ A
3374 lm 3000K



Finishings | Acabados | Finitions
05 Black | Negro | Noir

Materials | Materiales | Matériaux
AL Aluminium | Aluminio | Aluminium
PMMA Diffuser material PMMA | Material difusor PMMA | Matériau diffusant PMMA

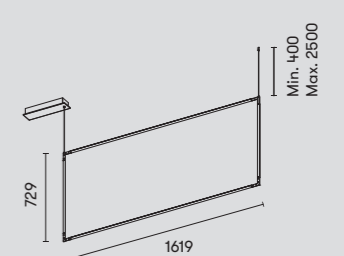

00-8271-05-M1 ■ 100-305V (DALI)
00-8299-05-M1 ■ 176-305V

LED 107.2W A++ A
3936 lm 3000K

TUBS MODULAR

STANDARD COMBINATIONS - COMBINACIONES ESTÁNDAR - COMBINAISONS STANDARD

For more standard combinations, consult our configurator at groklighting.com Consult our commercial team for custom combinations.
 Para más combinaciones estándares consultar configurador en groklighting.com. Consultar equipo comercial para combinaciones a medida.
 Pour plus de combinaisons standard, consulter le configurateur sur groklighting.com. Consulter l'équipe commerciale pour des combinaisons sur mesure.

PENDANT - SUSPENSIÓN - SUSPENSION

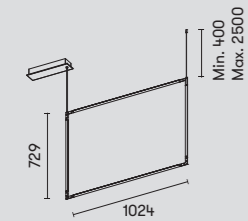

00-8269-05-M1 ■ 100-305V (DALI)
00-8298-05-M1 ■ 176-305V

LED 75.5W A++ A
 2811 lm 3000K

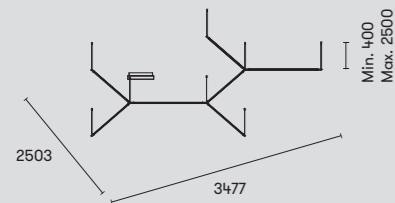

00-8280-05-M1 ■ 100-305V (DALI)

LED 157.5W A++ A
 2811 lm 3000K

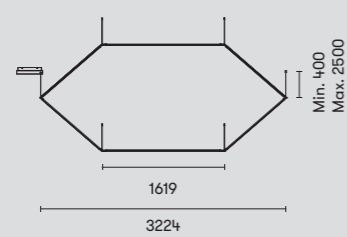

00-8278-05-M1 ■ 90-305V (DALI)

LED 231W A++ A
 843+ lm 3000K

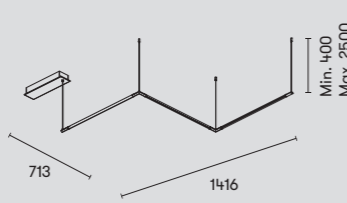

00-8284-05-M1 ■ 100-305V (DALI)
00-8300-05-M1 ■ 176-305V

LED 45.3W A++ A
 1687 lm 3000K



Finishings | Acabados | Finitions

05 Black | Negro | Noir

Materials | Materiales | Matériaux

AL Aluminium | Aluminio | Aluminium

PMMA Diffuser material PMMA | Material difusor
 PMMA | Matériau diffusant PMMA

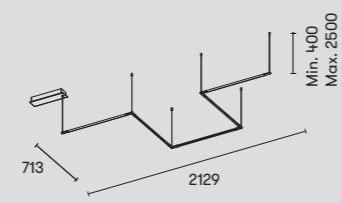

00-8285-05-M1 ■ 100-305V (DALI)
00-8301-05-M1 ■ 176-305V

LED 75.5W A++ A
 2811 lm 3000K

WALL - PARED - MURAL

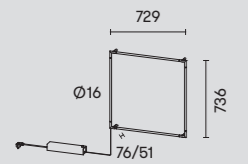

05-8255-05-M1 ■ 90-305V (PWM)

LED 61W
 2249 lm 3000K

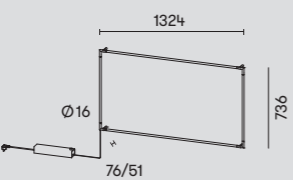

05-8260-05-M1 ■ 90-305V (PWM)

LED 90W
 843 lm 3000K

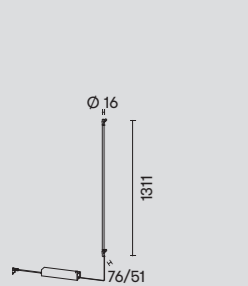

05-8251-05-M1 ■ 90-305V (PWM)

LED 30.5W
 1125 lm 3000K

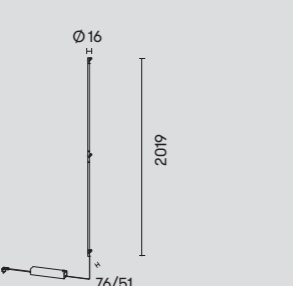

05-8250-05-M1 ■ 90-305V (PWM)

LED 45W
 1687 lm 3000K



Finishings | Acabados | Finitions

05 Black | Negro | Noir

Materials | Materiales | Matériaux

AL Aluminium | Aluminio | Aluminium

PMMA Diffuser material PMMA | Material difusor
 PMMA | Matériau diffusant PMMA

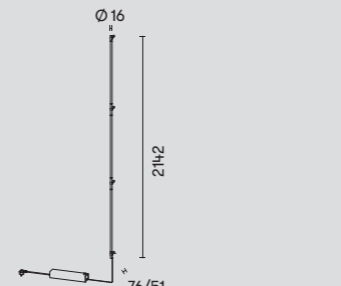

05-8283-05-M1 ■ 90-305V (PWM)

LED 245.3W
 1687 lm 3000K

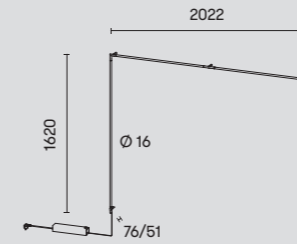

05-8289-05-M1 ■ 90-305V (PWM)

LED 83.5W
 3092 lm 3000K

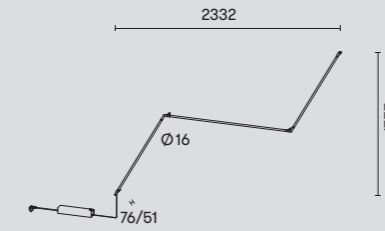

05-8287-05-M1 ■ 90-305V (PWM)

LED 75.5W
 2811 lm 3000K

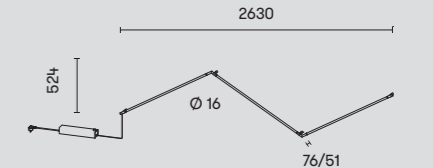

05-8291-05-M1 ■ 90-305V (PWM)

LED 67.5W
 2530 lm 3000K

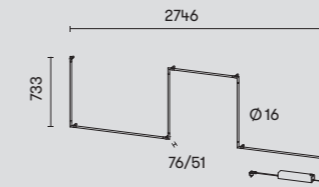

05-8290-05-M1 ■ 90-305V (PWM)

LED 105.4W
 3936 lm 3000K

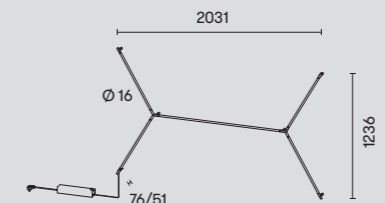

05-8286-05-M1 ■ 90-305V (PWM)

LED 90W
 3374 lm 3000K

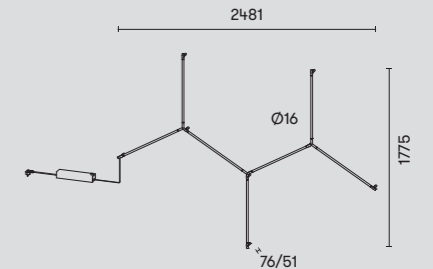

05-8279-05-M1 ■ 90-305V (PWM)

LED 107.2W
 3936 lm 3000K

UMBRELLA

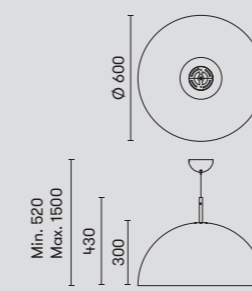

00-2727-AP-05 ■
00-2727-AQ-78

3 x E-14 Max. 11W A++ C
 Max. L=145mm Ø=45mm
 Fluorescent - LED

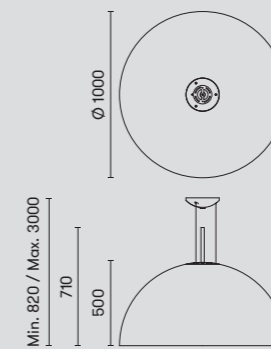

00-2726-AP-05 ■
00-2726-AQ-78

3 x E-27 Max. 23W A++ C
 Max. L=150mm Ø=60mm
 Fluorescent - LED



Finishings | Acabados | Finitions

05 Black | Negro | Noir

+ AP Golden pleated interior shade | Pantalla interior plisada dorada | Intérieur d'abat-jour plissé doré

78 White lacquered | Lacado blanco | Laqué en blanc

+ AQ Metallic grey. Silver pleated interior shade | Gris metalizado. Pantalla interior plisada plata | Gris metalisé. Intérieur d'abat-jour plissé argenté

Materials | Materiales | Matériaux

TEX TIL Fabric | Tela | Tissu

PMMA PMMA | PMMA

GLASS MAT Diffuser material matt glass | Material difusor vidrio mate | Matériau diffusant verre

VOILES

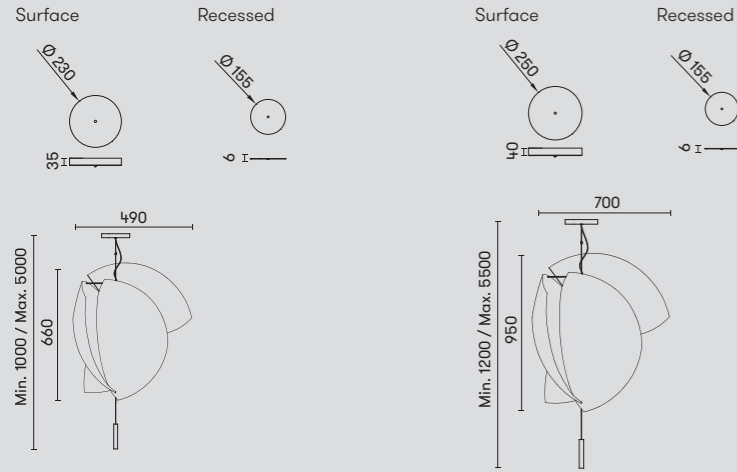

Surface
00-6306-21-14 (Phase Cut) 220-240V
00-6307-21-14 (1-10V) 100-240V
00-6308-21-14 (Dali) 100-277V
 LED 32.5W
 2618 lm 3000K

Surface
00-7691-21-14 (Phase Cut) 220-240V
00-7692-21-14 (1-10V) 100-240V
00-7693-21-14 (Dali) 100-277V

LED 32.5W
 2618 lm 2700K

Recessed
00-6317-21-14 (Phase Cut) 220-240V
00-6318-21-14 (1-10V) 100-240V
00-6319-21-14 (Dali) 100-277V

LED 32.5W
 2618 lm 3000K

Recessed
00-7694-21-14 (Phase Cut) 220-240V
00-7695-21-14 (1-10V) 100-240V
00-7696-21-14 (Dali) 100-277V

LED 32.5W
 2618 lm 2700K

Surface
00-6303-21-14 (Phase Cut) 220-240V
00-6304-21-14 (1-10V) 100-240V
00-6305-21-14 (Dali) 220-240V
 LED 47.5W
 4480 lm 3000K

Surface
00-7685-21-14 (Phase Cut) 220-240V
00-7686-21-14 (1-10V) 100-240V
00-7687-21-15 (Dali) 220-240V

LED 47.5W
 4480 lm 2700K

Recessed
00-6314-21-14 (Phase Cut) 220-240V
00-6315-21-14 (1-10V) 100-240V
00-6316-21-14 (Dali) 220-240V

LED 47.5W
 4480 lm 3000K

Recessed
00-7688-21-14 (Phase Cut) 220-240V
00-7689-21-14 (1-10V) 100-240V
00-7690-21-14 (Dali) 220-240V

LED 47.5W
 4480 lm 2700K

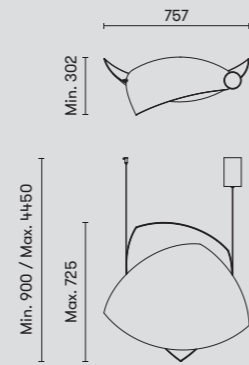

15-7723-21-14 (Driver TCI: On-Off / 1-10V / Dali)

LED 29.4W
 2090 lm 2700K

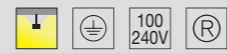

Finishings | Acabados | Finitions

21 Chrome | Cromo | Chrome

Materials | Materiales | Matériaux

ST Steel | Acero | Acier

PAPER SHADE Shade material japanese paper | Material pantalla papel japonés | Matériau de l'abat-jour en papier japonais

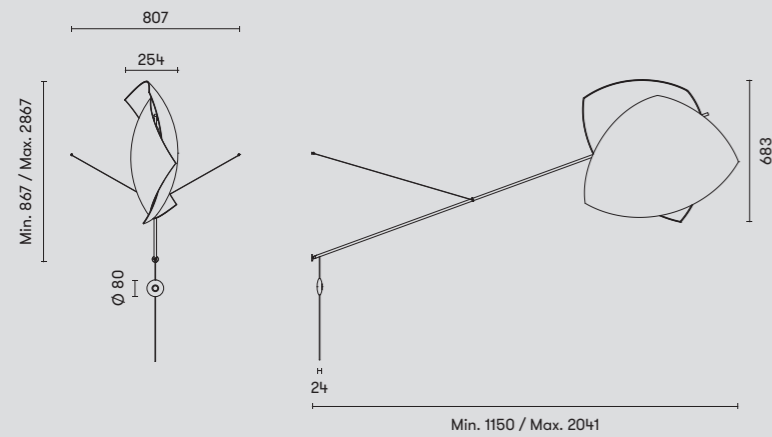

05-7723-05-14 (Touch dimming)

LED 29.4W A++ A
 2090 lm 2700K



Finishings | Acabados | Finitions

05 Black | Negro | Noir

Materials | Materiales | Matériaux

ST Steel | Acero | Acier

PAPER SHADE Shade material japanese paper | Material pantalla papel japonés | Matériau de l'abat-jour en papier japonais

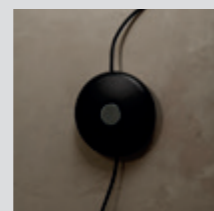

Touch dimmer

MATERIALS

MATERIALES

MATÉRIAUX

ABS	ABS	ABS	ABS
ALB	Alabaster	Alabastro	Alabastro
AL	Aluminium	Aluminio	Aluminium
MRBL	Marble	Mármol	Marbre
PMMA	PMMA	PMMA	PMMA
PUR	Polyurethane	Poliuretano	Polyuréthane
ST	Steel	Acero	Acier
TEXTIL	Fabric	Tela	Tissu
WOOD	Wood	Madera	Bois
ZAMAK	Zamak	Zamak	Zamak

DIFFUSERS

DIFUSORES

DIFFUSEURS











GLASS DIF	Diffuser material glass	Material difusor cristal	Matériau diffusant verre
GLASS MAT DIF	Diffuser material matt glass	Material difusor vidrio mate	Matériau diffusant verre mat
GLASS OPAL3 DIF	Diffuser material triplex opal glass	Material difusor cristal opal triplex	Matériau diffusant verre opal triplex
GLASS OPT DIF	Diffuser material optic glass	Material difusor cristal óptico	Matériau diffusant verre optique
GLASS TRANS DIF	Diffuser material transparent glass	Material difusor cristal transparente	Matériau diffusant verre transparent
PMMA DIF	Diffuser material PMMA	Material difusor PMMA	Matériau diffusant PMMA
PC DIF	Diffuser material polycarbonate	Material difusor policarbonato	Matériau diffusant polycarbonate
PS DIF	Diffuser material polystyrene	Material difusor poliestireno	Matériau diffusant polystyrène

SHADES

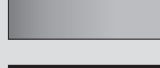
PANTALLAS

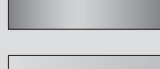
ABAT-JOURS

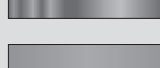
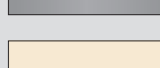
FELT SHADE	Shade material felt	Material pantalla fieltro	Matériels abat-jour fieltro
PMMA SHADE	Shade material PMMA	Material pantalla PMMA	Matériels abat-jour PMMA
PC SHADE	Shade material polycarbonate	Material pantalla policarbonato	Matériels abat-jour polycarbonate
PAPER SHADE	Shade material japanese paper	Material pantalla papel japonés	Matériau de l'abat-jour en papier japonais
PVC SHADE	Shade material PVC	Material pantalla PVC	Matériels abat-jour PVC
TEXTIL SHADE	Shade material fabric	Material pantalla tela	Matériels abat-jour tissu

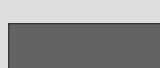
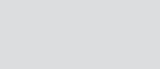
	FINISHINGS	ACABADOS	FINITIONS
	01 Gold plating	Oro electrolítico	Dorure à l'or par électrolyse
	05 60 H13W Black	Negro	Noir
	06 Copper	Cobre	Cuivre
	14 T003 T007 White	Blanco	Blanc
	21 Chrome	Cromo	Chrome
	27 Matt satin finished brass	Latón satinado mate	Laiton satiné mat
	78 White lacquered	Lacado blanco	Laqué en blanc
	81 Satin nickel	Níquel satinado	Nickel satiné
	92 Fresno oscuro	Fresno oscuro	Frêne foncé
	93 Fresno claro	Fresno claro	Frêne clair
	AH Ecobright aluminium	Aluminio ecobright	Aluminium ecobright
	AJ Opera grey	Gris ópera	Gris opéra
	AP Golden pleated interior shade	Pantalla interior plisada dorada	Intérieur d'abat-jour plissé doré
	AQ Metallic grey. Silver pleated interior shade	Gris metalizado. Pantalla interior plisada plata	Gris métallisé. Intérieur d'abat-jour plissé argenté
	AF Satin aluminium	Aluminio satinado	Aluminium satiné
	BY Beige	Beige	Beige
	BW Matt white	Blanco mate	Blanc mate
	DO Matt gold	Dorado mate	Doré mat
	EF Gold painted	Dorado pintado	Doré peint
	CT Wood brown	Marrón madera	Bois marron
	Z5 Anthracite grey	Gris antracita	Gris anthracite

	SYMBOLS	SIMBOLOGÍA	SYMBOLES
	Class I	Clase I	Classe I
	Class II	Clase II	Classe II
	Class III	Clase III	Classe III
	Registered models	Modelos registrados	Modèles enregistrés
	Resistance to incandescent wire at XXX°C	Resistente al hilo incandescente a XXX°C	Tenue au feu XXX°C
	Items per box	Uds. de embalaje	Unité d'emballage
	Ceiling installation	Instalación en el techo	Installation au plafond
	Dimmer	Regulador de intensidad	Régulateur d'intensité
	Touch dimmer	Regulador de intensidad táctil	Variateur d'intensité tactile
	On/off switch	Interruptor de encendido	Interrupteur simple allumage
	Double on/off switch	Doble interruptor de encendido	Interrupteur double allumage
	Cable on/off switch	Interruptor de encendido en el cable	Interrupteur d'allumage sur le câble
	Remote control included	Mando a distancia incluido	Télécommande fournie
	Controller with remote control	Controlador con mando a distancia	Contrôleur avec télécommande
	Batteries included	Pilas incluidas	Piles fournies
	Please, contact our sales team	Consulte con equipo comercial	Consultez l'équipe commerciale
	Electrical compatibility	Compatibilidad eléctrica	Compatibilité électrique
	Hole dimensions for recessing	Corte de empotramiento	Coupe d'encastrement
	Rotating	Giratorio	Giratoire
	355° rotation	Giratorio 355°	Giratoire 355°
	Energy efficiency	Eficiencia energética	Efficienc e énergétique
	Shade material	Material pantalla	Matériel Abat-jour
	Diffuser material	Material difusor	Matériel Diffuseur
	Power Led	Power Led	Power Led
	Minimum distance to be left between the focus of the lighting fixture and the lightened object	Distancia mínima entre el foco de la luminaria y el objeto iluminado	La distance minimum pour être gauche entre le foyer de l'accessoire d'éclairage et l'objet allumé
	Five-metre cable	Cable de 5 metros	Câble de 5 mètres
	RGB light	Luz RGB	Lumière RGB
	Halo light direction	Dirección del halo de luz	Direction du faisceau lumineux

GENERAL INFORMATION

INFORMACIÓN GENERAL

INFORMATION GÉNÉRALE

Due to the constant evolution of LED technology, those products which contain this light source can vary in their technical characteristics so as to ensure that we can always offer maximum product performance. | The descriptions and dimensions of the items in this catalogue are indicative and may be modified for the purpose of technical or design improvements. | We reserve the right to cancel or change all models without prior notice. | Do not use stronger bulbs than recommended, and always clean lamps with a soft dry cloth alone since metal polish will damage the protective finish. | Energy efficiency labels for all the products in the catalogue can be found at www.leds-c4.com.

All rights reserved. No part of this publication may be reproduced or transmitted in any form or by any means, electronic storage and retrieval system, without permission in writing from the copyright owner(s).

Debido a la constante evolución tecnológica del LED, los productos que incluyen esta fuente de luz pueden experimentar variaciones en sus características técnicas con el objetivo de poder ofrecer siempre las máximas prestaciones en nuestros productos. | Las descripciones y medidas de los aparatos del presente catálogo son orientativas, pudiendo por tanto ser modificadas, a fin de mejorar las características técnicas o de diseño. | La empresa se reserva el derecho de anular o modificar cualquier modelo sin previo aviso. | Para una buena conservación de las lámparas, no usar bombillas de potencia superior a las recomendadas y limpiar simplemente con un paño seco. No usar limpia metales, ya que dañan los barnices protectores que garantizan la duración del acabado. | Las etiquetas de eficiencia energética de todos los productos del catálogo están disponibles en la web www.leds-c4.com.

Todos los derechos reservados. Ninguna parte de este libro puede ser reproducida en ningún formato de papel o electrónico, sin el consentimiento previo del editor o de los propietarios de los derechos.

En raison de l'évolution constante de la technologie LED, les produits dotés de cette source lumineuse peuvent connaître des variations dans leurs caractéristiques techniques, en vue de toujours en optimiser les prestations. | Les descriptions et mesures des appareils de ce catalogue sont données à titre d'orientation, pouvant être modifiées dans le but d'améliorer les caractéristiques techniques ou de design. | L'usine se réserve le droit d'annuler ou modifier l'un ou l'autre de ses modèles sans avis préalable. | Ne pas utiliser d'ampoules d'une puissance supérieure à celle recommandée. Pour un bon entretien, utiliser simplement un chiffon sec. N'utilisez aucun produit pour métaux, ils abîment le vernis protecteur. | Les étiquettes de rendement énergétique pour tous les produits du catalogue sont disponibles sur le site www.leds-c4.com.

Tous droits réservés. Aucune partie de ce livre ne pourra être reproduite en format papier ou électronique sans l'autorisation préalable de l'éditeur ou du propriétaire des droits.



Manufactured according to the set safety and electromagnetism standards of Europe
Fabricado según normas de seguridad y electromagnetismo de Europa
Fabriqués en conformité avec les normes de sécurité et d'électromagnétique de l'Europe

INDEX

ÍNDICE

INDEX

REF.	PG.	REF.	PG.
00-7065-05-05	182	00-6667-14-27	185
00-7065-21-21	182	00-6667-14-60	185
00-7066-21-21	182	00-6668-14-60	185
00-7067-05-05	182	00-6669-14-60	185
00-7067-21-21	182	71-6022-60-60	184
00-7074-05-05	182	00-6021-60-60	184
00-7074-21-21	182	00-6663-14-27	184
00-7075-05-05	182	00-6662-14-60	184
00-7075-21-21	182	00-6018-60-60	184
00-7076-05-05	182	00-6017-60-60	184
00-7076-21-21	182	00-6665-14-27	185
00-7077-05-05	182	00-6664-14-27	185
00-7077-21-21	182	00-6669-14-27	185
00-6670-21-21	182	00-6668-14-27	185
00-6671-21-F1	182	71-6022-27-27	184
00-6670-05-05	182	00-6020-27-27	184
00-6671-05-F1	182	00-6067-27-27	185
00-7064-21-21	182	00-6019-27-27	184
00-7064-05-05	182	00-6066-27-27	185
00-7066-05-05	182	00-6017-27-27	184
05-4394-78-M1	183	00-6021-27-27	184
05-4394-AH-M1	183	00-6018-27-27	184
05-5085-BW-BW	183	00-8317-60-27	184
00-6662-14-27	185	00-8317-60-60	184
00-6663-14-60	185	00-8318-60-27	184
00-6664-14-60	185	00-8318-60-60	184
00-6665-14-60	185	00-8319-60-27	184
00-6666-14-27	185	00-8319-60-60	184
00-6666-14-60	185	00-8320-60-27	184

INDEX
ÍNDICE
INDEX

REF.	PG.	REF.	PG.
00-8320-60-60	184	00-6454-92-F9	202
71-8318-F9-F9	184	00-6463-92-F9	202
71-8320	184	00-6460-92-F9	202
00-7614-21-55	185	05-4787-81-81	199
00-7615-14-55	185	10-1940-BW-T007	200
20-7612-21-55	185	05-1940-81-81	199
20-7613-21-55	185	05-4787-BW-BW	199
00-3648-BW-M3	186	05-1941-BW-82	199
00-3646-BW-M3	186	25-1940-BW-T007	200
00-3647-BW-M3	186	10-1940-05-H13W	200
00-0641-BW-M3	186	05-1940-BW-BW	199
00-0642-BW-M3	186	05-1941-81-82	199
25-2934-BW-M3	187	25-1940-05-H13W	200
00-0001-BW-M3	186	71-4787-AV-AV	199
00-0002-BW-M3	186	PAN-175-14	198
00-3642-BW-M3	186	PAN-178-14	198
00-3649-BW-M3	186	PAN-179-14	198
71-2241-00-00	187	PAN-180-14	198
00-6454-93-F9	202	PAN-176-14	198
00-6457-92-F9	202	PAN-177-14	198
00-6011-93-F9	202	PAN-157-14	198
00-6457-93-F9	202	PAN-161-14	198
00-6458-92-F9	202	PAN-175-BY	198
00-6011-92-F9	202	PAN-178-BY	198
00-6460-93-F9	202	PAN-179-BY	198
00-6010-93-F9	202	PAN-180-BY	198
10-6011-92-F9	202	PAN-176-BY	198
00-6452-93-F9	202	PAN-177-BY	198
00-6463-93-F9	202	PAN-157-BY	198

REF.	PG.	REF.	PG.
PAN-161-BY	198	25-5693-05-05	204
00-5275-BW-M1	201	00-5694-05-05	203
00-5275-CT-M1	201	00-5693-05-05	203
05-3686-21-M1	197	05-5693-05-05	204
25-3686-21-M1	197	00-5696-05-05	203
05-7562-14-M1	196	00-5695-05-05	203
05-7563-14-M1	196	10-5693-05-05	204
05-7564-14-M1	196	00-3685-BW-M1	205
71-7563-21-21	196	10-5076-01-H13W	206
71-7563-DO-DO	196	25-5076-01-H13W	206
71-7564-21-21	196	10-5076-06-H13W	206
71-7564-DO-DO	196	25-5076-06-H13W	206
71-7579-05-00	194	05-5956-Z5-Z5	207
10-7063-05-05	194	00-0054-05-BW	207
10-7063-14-14	194	05-5956-BW-BW	207
10-8327-14-14	194	00-7727-05-EK	209
10-8327-05-05	194	00-7727-05-EQ	209
10-8327-EX-EX	194	00-7728-05-EK	209
00-7382-05-05	203	00-7728-05-EQ	209
00-7383-05-05	203	00-7731-05-EK	209
00-7384-05-05	203	00-7731-05-EQ	209
00-7385-05-05	203	00-7729-05-EK	209
10-7385-05-05	204	00-7729-05-EQ	209
25-7385-05-05	204	00-7730-05-EK	209
05-7383-05-05	203	00-7730-05-EQ	209
05-7382-05-05	203	00-7732-05-EK	209
05-7385-05-05	204	00-7732-05-EQ	209
05-7380-05-05	203	00-6015-27-M1	208
05-7381-05-05	203	00-6014-27-M1	208

INDEX
ÍNDICE
INDEX

REF.	PG.	REF.	PG.
05-4750-14-F9	210	00-6000-05-M1	211
00-6316-21-14	218	00-5999-05-M1	211
00-6318-21-14	218	00-2727-AQ-78	217
00-6319-21-14	218	00-2726-AQ-78	217
00-7685-21-14	218	00-2726-AP-05	217
00-7686-21-14	218	00-2727-AP-05	217
00-7687-21-14	218	05-8102-05-M1	211
00-7688-21-14	218	05-8103-05-M1	211
00-7689-21-14	218	05-8104-05-M1	211
00-7690-21-14	218	10-8102-05-M1	212
00-7691-21-14	218	25-8102-05-M1	212
00-7692-21-14	218	71-8247-05-M1	213
00-7693-21-14	218	71-8248-05-M1	213
00-7694-21-14	218	71-8249-05-M1	213
00-7695-21-14	218	71-8250-05-M1	213
00-7696-21-14	218	71-8265-05-05	213
05-7723-05-14	218	71-8266-05-05	213
15-7723-21-14	218	71-8267-05-05	213
00-6307-21-14	218	71-8268-05-05	213
00-6315-21-14	218	71-8287-05-05	213
00-6304-21-14	218	71-8251-05-05	216
00-6317-21-14	218	71-8252-05-05	216
00-6314-21-14	218	71-8253-05-05	216
00-6305-21-14	218	71-8254-05-05	216
00-6308-21-14	218	71-8255-05-05	216
00-6306-21-14	218	71-8256-05-05	216
00-6303-21-14	218	71-8257-05-05	216
00-6001-05-M1	211	71-8258-05-05	216
00-6002-05-M1	211	71-8259-05-05	216

REF.	PG.	REF.	PG.
71-8260-05-05	216	05-8283-05-M1	216
71-8261-05-05	216	05-8289-05-M1	217
71-8262-05-05	216	05-8287-05-M1	217
71-8263-05-05	216	05-8291-05-M1	217
71-8264-05-05	216	05-8290-05-M1	217
71-8286-05-05	215	05-8286-05-M1	217
00-8248-05-M1	215	05-8279-05-M1	217
00-8292-05-M1	215	CDXX-00X9AZXXXX	188-191
00-8256-05-M1	215	CFXX-00X9AZXXXX	188-191
00-8294-05-M1	215	CSXX-00X9AZXXXX	188-189
00-8259-05-M1	215	CVXX-00X9AZXXXX	188-191
00-8295-05-M1	215	CPXX-00X9AZXXXX	182-183
00-8266-05-M1	215		
00-8297-05-M1	215		
00-8271-05-M1	215		
00-8299-05-M1	215		
00-8269-05-M1	216		
00-8298-05-M1	216		
00-8278-05-M1	216		
00-8280-05-M1	216		
00-8284-05-M1	216		
00-8300-05-M1	216		
00-8285-05-M1	216		
00-8301-05-M1	216		
05-8255-05-M1	216		
05-8256-05-M1	216		
05-8260-05-M1	216		
05-8251-05-M1	216		
05-8250-05-M1	216		

CLOSE TO YOU

Grok, a brand of LEDS C4 Group.

With over forty years' experience in the lighting sector, the LEDS C4 Group designs and produces architectural and decorative lighting products which aim to transform spaces and improve people's wellbeing through the use of light.

Grok, una marca de LEDS C4 Group.

Más de cuatro décadas dedicadas al sector de la iluminación, el Grupo LEDS C4, diseña y produce productos de iluminación arquitectónica y decorativa, con el fin de transformar los espacios y mejorar el bienestar de las personas a través de la luz.

Grok, une marque de LEDS C4 Group.

Après plus de 4 décennies consacrées au secteur de l'illumination, le Groupe LEDS conçoit et crée des produits d'illumination architecturale et décorative, dans le but de transformer les espaces et améliorer le bien-être des personnes à travers la lumière

Headquarters

-
LEDS C4, S.A.
Afores sn, 25750 Torà | Lleida | Spain
+34 973 468 100
leds-c4@leds-c4.com

Customer Service**Spain**

-
+34 973 468 101
spain@leds-c4.com

UK

-
0808 234 2641
uk@leds-c4.com

France

-
+34 973 468 130
france@leds-c4.com

Germany

-
0800 188 0989
deutschland@leds-c4.com

Italy

-
800 784 275
italia@leds-c4.com

Portugal

-
+34 973 468 130
portugal@leds-c4.com

Europe

-
+34 973 468 102
europe@leds-c4.com

Latin America

-
+34 973 468 115
latinamerica@leds-c4.com

Asia Pacific - Africa

-
+34 973 468 116
asiapacific@leds-c4.com
africa@leds-c4.com

Canada

-
Toll-free: +1-866-5636666
customerserviceus@leds-c4.com

United States

-
Toll-free: +1-888-3710243
customerserviceus@leds-c4.com

PRESS

+34 973 468 117
comunicacion@leds-c4.com

SUPPLIERS

+34 973 468 113
compras@leds-c4.com

CREDITS

Madrid

-
Joaquín Turina, 2, 28224 Pozuelo de Alarcón | Spain

Middle East

-
Fortune Executive Tower | JLT
Po 336910 | Dubai | Uae
+971 4458 4272
middleeast@leds-c4.com

Asia Pacific

-
8 Robinson Road, #03-00 ASO Building
048544 Singapore
+65 8133 5024

Colombia

-
Carrera 18, N°. 86A-14
110221 Bogotá
+57 1638 6012

Germany

-
im Wissenschaftspark Deutschland GmbH
Munscheidstraße 14
45886 Gelsenkirchen
+49 209 2755 1228
deutschland@leds-c4.com

Poland

-
ul.Nektarowa 11B 52-210.
Wroclaw POLAND
+48 71 733 64 01
biuro@leds-c4.pl

South Africa

-
Office 114, Regus Business Centre
(AMR Building)
3 Concorde Road East
20007 Bedfordview South Africa
+27 100 075 231
+27 844 595 025

Art Direction

-
Isern Serra

Design

-
Nomon Design

Photography

-
Jordi Anguera
Jordi Balcells
Albert Font
Salva López
Jordi Miralles
Santi de Pablo
Marçal Vaquer

3D Renders

-
Alga Studio
Visualizers

Printing

-
CeGe



