

**VIELFALT ENTDECKEN** *DISCOVER DIVERSITY*





## COLOUR CODE

<b>A</b>	<b>plastic</b>				
A3	black	<b>GH</b>	<b>glass effect - back-cloth lacquered</b>	<b>MS</b>	<b>solid brass</b>
A4	white	GH1	white	MS1	polished brass
A5	red	GH2	black	MS2	satin brass
A7	brown			MS3	antique brass
A9	multicolour	<b>GL</b>	<b>plastic - gloss lacquered</b>	MS4	bright chrome
A12	brown	GL35	black	MS8	stainless steel effect
A13	matt chrome	GL36	white		
A15	antique silver	GL39	navy blue	<b>MT</b>	<b>plastic - metallized</b>
A17	transparent blue/red	GL41	pink	MT1	bright chrome
A18	transparent blue			MT3	bright gold
A20	purple	<b>HZ</b>	<b>wood</b>	MT7	matt nickel
A22	antique red	HZ1	oak		
A24	antique green	HZ2	oak lacquered	<b>MV</b>	<b>plastic - metallic velour</b>
A25	salmon red	HZ4	beech lacquered to mahogany	MV2	chrome
A28	antique brass	HZ5	pine	MV7	nickel
A29	red	HZ6	pine lacquered	MV10	anthracite
A38	ivory	HZ11	ash	MV11	aluminium
A39	teddy bear	HZ13	cherry lacquered	MV106	aluminium
A40	hippo	HZ14	oak lacquered		
A41	lion	HZ16	spruce	<b>N</b>	<b>stainless steel</b>
A42	zebra	HZ17	beech	N1	stainless steel
A43	ladybird	HZ18	beech lacquered		
A44	wasp	HZ21	beech white lacquered	<b>PB</b>	<b>metal</b>
A45	transparent	HZ33	alder	PB1	white
A49	bright chrome	HZ34	maple lacquered	PB6	ruby red
A51	pink	HZ35	maple	PB7	dark brown
A53	orange	HZ37	alder lacquered	PB8	black
A54	red	HZ42	pine white glazed	PB12	matt black
A55	yellow	HZ46	beech aluminium	PB13	matt gold
A56	purple	HZ55	nut lacquered	PB15	chocolate-brown
A57	yellow	HZ61	cherry lacquered to mahogany	PB16	antique black
A58	white	HZ62	beech lacquered to wenge	PB18	dark grey
A59	pink	HZ63	beech lacquered to mahogany	PB19	silver grey
A66	white/pink	HZ64	beech lacquered pink	PB20	antique brown
A67	yellow/white	HZ66	beech lacquered pink	PB21	aluminium
A68	white/yellow	HZ67	beech lacquered blue	PB32	matt white
A78	beige	HZ68	beech lacquered yellow	PB32C	white matt lacquered
A79	rose	HZ69	oak lacquered to birchbark	PBS22	cream white
A80	blue	HZS224	birch/cherry lacquered	<b>PC</b>	<b>ceramic - cracked effect</b>
A81	nickel			PC5	light beige
A83	pink	<b>J</b>	<b>crystal</b>	PC6	beige/grey
A84	green	J1	clear 3 x 3 mm		
A105	aluminium	J3	clear 5 mm	<b>PD</b>	<b>print decor for ceramic</b>
A109	aluminium	J13	clear 2,8 mm	PD1	gold
A110	white translucent			PD3	blue
A123	red	<b>JE</b>	<b>jewel effect (Strass)</b>	PD5	grey
A124	blue	JE4	clear 14 mm		
A134	yellow/black	JE7	flower clear	<b>PF</b>	<b>ceramic - coloured</b>
A138	anthracite	JE8	flower blue/red	PF10	multicolour
A139	grey	JE17	clear 4 mm	PF11	multicolour
A141	silver grey			PF12	multicolour
		<b>K</b>	<b>plastic</b>	PF13	multicolour
<b>AC</b>	<b>acrylic colours</b>	K1	black	PF14	multicolour
AC1	transparent clear	K2	brown	PF15	multicolour
AC14	transparent blue	K7	fire red	PF16	multicolour
		K10	white	PF17	yellow
<b>AL</b>	<b>aluminium - anodized</b>	K12	brown transparent	PF18	yellow/mandala
AL1	natural matt	K19	brilliant blue	PF19	orange
AL2	natural brightened	K27	silver grey	PF20	orange/mandala
AL26	matt gold	K29	stone grey	PF21	light beige
AL62	matt nickel	K31	ruby red	PF25	white/blue
AL72	stainless steel effect	K39	light grey	PF30	dark blue/white
		K52	dark brown	PF31	multicolour
<b>BD</b>	<b>plastic - picture decor</b>	K60	pure white	PF32	white/blue
BD18	multicolour	K63	agate grey	PF33	multicolour
		K72	peach	PF34	white/floral
<b>BDJ</b>	<b>plastic - picture decor with crystal stone</b>	K77	matt silver		
BDJ1	blue/train	K81	purple	<b>PU</b>	<b>plastic foamed</b>
BDJ2	rose/fairy	K87	white	PU4	dolphin
BDJ3	blue/car	K90	pearl grey		
		<b>KG</b>	<b>plastic - glass effect</b>	<b>RP</b>	<b>plastic coated</b>
<b>CF</b>	<b>plastic colour foil-effect</b>	KG11	orange	RP85	aluminium
CF1	white			<b>RU</b>	<b>plastic - rubber effect</b>
CF3	carmine	<b>KGSA</b>	<b>plastic - glass effect (SAN)</b>	RU1	red
CF7	blue	KGSA1	clear	RU2	white/black
		KGSA3	blue	RU3	yellow
<b>CP</b>	<b>plastic - wood effect</b>	KGSA5	green	RU4	blue
CP2	copper beech	<b>KGSU</b>	<b>plastic - glass effect (Surlyn)</b>	RU5	rose
CP34	hazel	KGSU1	clear	RU6	orange
CP100G	Groot wood	KGSU3	green	RU8	rose
CP123M	red alder	KGSU4	red	RU12	coloured
				RU13	coloured
<b>DB</b>	<b>print - decor for plastic</b>	<b>KM</b>	<b>plastic - matt glass effect</b>	RU14	grey
DB3	beech	KM1	natural	RU15	green
		KM3	blue	RU36	dark blue
<b>DK</b>	<b>decor effect for plastic</b>	KM9	jade green	RU40	green
DK5	rose multicolour	<b>KMSU</b>	<b>plastic - glass effect matt (Surlyn)</b>	RU41	blue
DK193	wenge	KMSU5	yellow	RU42	red
		KMSU7	blue	RU43	blue
<b>E</b>	<b>plastic - stainless steel effect</b>	<b>LS</b>	<b>artificial leather</b>	RU44	purple/pink
E2	stainless steel effect	LS7	black	RU45	coloured
		LS8	brown	RU46	coloured
<b>FE</b>	<b>iron</b>	LS9	beige	RU47	coloured
FE2	polished chrome	<b>MC</b>	<b>plastic - metallic</b>	<b>S</b>	<b>plastic</b>
FE11	sheet steel galvanized	MC23	purple	S90	black/aluminium
FE13	chalkboard paint black			<b>SD</b>	<b>plastic - stone decor</b>
		<b>MF</b>	<b>metal foil-effect for plastic</b>	SD1	white/transparent
<b>G</b>	<b>plastic - galvanized</b>	MF1	bright gold	SD3	white/anthracite
G1	bright chrome	MF2	bright silver		
<b>GE</b>	<b>plastic - glass effect</b>	MF15	titan silver		
GE1	clear	MF18	aluminium		
GE8	light green				
GE28	salmon				
		<b>SN</b>	<b>plastic - wood structure</b>		
		SN1	transparent		
		SN9	orange		
		SN10	red		
		SN11	rose		
		SN12	light green		
		SN13	light blue		
		SN14	olive green		
		SN15	yellow		
		SN16	blue		
		SN17	green		
		SN18	orange		
		SN19	pink		
		SN26	raspberry red		
		<b>SP</b>	<b>white ceramic</b>		
		<b>T</b>	<b>plastic - rubber effect</b>		
		T7	black		
		T16	blue		
		<b>TK</b>	<b>terracotta</b>		
		TK2	natural/white		
		<b>TX</b>	<b>plastic - textile</b>		
		TX1	green		
		<b>VG</b>	<b>solid plastic - coloured through</b>		
		VG1	black		
		<b>ZN</b>	<b>metal - galvanized*</b>		
		ZN1	bright chrome		
		ZN2	matt chrome		
		ZN3	bright nickel		
		ZN4	matt nickel		
		ZN5	bright brass		
		ZN8	antique iron		
		ZN8+	antique iron brushed		
		ZN9	antique tin		
		ZN10	antique brass trumbled		
		ZN10+	antique brass brushed		
		ZN15	matt black		
		ZN16	bright black chrome		
		ZN19	antique copper		
		ZN20	gold		
		ZN21	stainless steel effect		
		ZN22	satin chromplated		
		ZN24	antique copper		
		ZN27	matt stainless steel effect		
		ZN28	tin		
		ZN29	antique silver		
		ZN31	antique brass		
		ZN32	zinc		
		ZN33	green		
		ZN34	blue		
		ZN35	black		
		ZN36	antique tin		
		ZN37	antique silver		
		ZN40	antique copper		
		ZN43	antique brass		
		ZN46	antique silver		
		ZN48	antique brass		
		ZN50	antique tin		
		ZN51	polished tin		
		ZN53	matt silver		
		ZN50	antique tin		
		ZN58	antique brass		
		ZN60	antique brass		
		ZN61	white		
		ZN63	antique iron		
		ZN66	rusty effect		
		ZN68	matt black chrome		
		ZN74	brushed matt copper		
		ZN75	brushed iron effect		
		ZN77	black copper		
		ZN78	trumbled iron effect		
		ZN79	brushed antique brass		
		ZN80	matt chrome		
		ZN81	stainless steel effect		
		ZN82	matt brass		
		ZN83	vintage gold		
		<b>ZNS</b>	<b>metal - galvanized*</b>		
		ZNS5	antique brass		

\* Vintage colours: surface variations are possible as manually treated



# INHALT contents

	METALL / metal SEITE / page 34 - 183
	METALL HYBRIDGRIFFE & GRIFFLEISTEN / metal hybrid handles & integrated handles SEITE / page 36 - 41
	EDELSTAHL / stainless steel SEITE / page 184 - 199
	SPECIAL EDITION made with SWAROVSKI® ELEMENTS SEITE / page 200 - 203
	KUNSTSTOFF / plastic SEITE / page 204 - 259
	KUNSTLEDER / imitation leather SEITE / page 260 - 263
	KERAMIK / ceramic SEITE / page 264 - 273
	HOLZ / wood SEITE / page 274 - 287
	HAKEN / hooks SEITE / page 288 - 345
	ZIERHAKEN / decorative hooks SEITE / page 314 - 349
	HAKEN UND HAKENLEISTEN SELBSTKLEBEND / hooks and hookrails self-adhesive SEITE / page 350 - 357
	HAKENLEISTEN / hookrails SEITE / page 358 - 383
	SONDERARTIKEL / special items SEITE / page 384 - 403
	MULTIPACKS SEITE / page 404 - 411
	WERBEMATERIAL / promotion material SEITE / page 411

# INHALT contents



**VERKAUFSHILFEN / display racks**  
SEITE / page 412 - 425



**SIRO LICHT / SIRO LIGHTING**  
SEITE / page 422 - 424



**SIRO PRODUKTFINDER / SIRO product finder**  
SEITE / page 425



**VARIO CLICK, VARIO SECURE**  
SEITE / page 416



**INDUSTRIE PLUS / industry plus**  
SEITE / page 420 - 421



Factory in Poland 

**SIRO BIELSKO**  
SEITE / page 426



**SIRO Prospekte / SIRO prospects**  
SEITE / page 427



ALLGEMEINE GESCHÄFTSBEDINGUNGEN  
SIRO BIELSKO Sp. z o.o. 2023

**VERKAUF- und LIEFERBEDINGUNGEN / terms of sale and delivery**  
SEITE / page 428 - 429

4	0706	160	357	134	579
4	0715	160	358	134	580
4	0724	160	361	134	582
7	0753	159	361	343	583
4	0765	159	364	134	584
4	0771	158	364	342	605
5	0788	290	365	134	606

**ARTIKELSUCHE / article index**  
SEITE / page 430 - 432

orange/blau/grün (rot/gelb)	H24	Buche mahagonifarbig gebeizt lackiert	MS
orange	H25	Kiefer roh	MS
rot	H26	Kiefer natur lackiert	MS
sonnen gelb	H211	Eiche roh	MS
lila	H213	Kirsch natur lackiert	MS
gelb	H214	Eiche natur lackiert	MS
weiß	H216	Fichte roh	MS
rosa	H217	Buche roh	MS
schwarzbraun	H218	Buche natur lackiert	MS
weiß/graub	H221	Buche weiß lackiert	MS
gelb/weiß	H233	Eiche roh	MS
weiß/gelb	H234	Ahorn natur lackiert	MS
Marmor	H235	Ahorn roh	MS

**AUSFÜHRUNGSBEZEICHNUNGEN / colour code**  
**AUSKLAPPSEITEN / fold out sides**



Vielfalt entdecken Discover Diversity



---

# FASHION FOR FURNITURE

---



*Tradition und Beständigkeit kombiniert mit Innovationsstreben hat SIRO zu einem der führenden Erzeuger und Anbieter dekorativer Möbelbeschläge gemacht. Das Design immer am Puls der Zeit weiter zu entwickeln, gehört ebenso zur täglichen Arbeit von SIRO, wie passende Produkte zu entwickeln die den weltweit unterschiedlichsten Anforderungen an Optik und Funktion entsprechen.*

*Tradition and continuity combined with innovation have made SIRO a leading manufacturer and supplier of decorative furniture fittings. Always adjusting design to the pulse of time and developing products that meet the world's diverse requirements for appearance and function are part of SIRO's daily work.*







---

# TIMELESS TREND MATT BLACK

---

*Die derzeit in vielen Bereichen dominierende Trendfarbe Schwarz wurde auch im Hause SIRO groß umgesetzt. Schwarz findet immer seinen Raum – zeitlos elegantes Design und ausgefallene Formen erlauben eine individuelle und edle Möbelgestaltung. Beschläge und Haken bilden in den Kontrastfarben Schwarz und Weiß eine perfekte Ergänzung für zeitgemäße Möbel.*

*SIRO has embraced the current fashion for black, which now dominates in so many areas. Black is always the right choice – timeless, elegant design and unusual shapes furniture that unique, but classy touch. Fittings and hooks in contrasting black and white form the perfect complement to contemporary furniture.*

---

**PB12** schwarz matt – matt black





---

# MODERN VINTAGE

---

Das Design immer am Puls der Zeit weiter zu entwickeln, gehört zur täglichen Arbeit von SIRO. Neuartige Farbmischungen sorgen für beliebtes Vintage-Flair und das gewisse Etwas. Ein besonderes Highlight stellen hierbei Beschläge und Haken in der Farbe Vintage Gold dar, die alten und neuen Möbeln einen besonderen Glanz verleihen. Dabei wird jedes Produkt individuell von Hand vollendet.

At SIRO, we continuously develop our designs to ensure they stay up to date. New colour mixtures add that popular vintage flair and make a space extra special. We are particularly proud of our fittings and hooks in the colour Vintage Gold, which add sparkle to both old and new furniture. Each product is hand finished individually.

- 
- ZN75** Eisen gebürstet – brushed iron effect
  - ZN77** Kupfer schwarz – black copper
  - ZN78** Eisen getrommelt – trumbled iron effect
  - ZN79** Messing antik gebürstet – brushed antique brass
  - ZN83** Vintage Gold – vintage gold



Vintagefarben: können aufgrund manueller Bearbeitung Oberflächenunterschiede aufweisen.

Vintage colours: surface variations are possible as manually treated.





**Hybridgriffe & Griffleisten Metall**  
**integrated handle metal**



**Art.-Nr. 2467**  
Seite / page 38



**Art.-Nr. 2466**  
Seite / page 38



**Art.-Nr. 2454**  
Seite / page 36



**Art.-Nr. 2447**  
Seite / page 36



**Art.-Nr. 2446**  
Seite / page 38



**Art.-Nr. 2356**  
Seite / page 36



**Art.-Nr. 2373**  
Seite / page 39



**Art.-Nr. 2372**  
Seite / page 40



**Art.-Nr. 2311**  
Seite / page 40

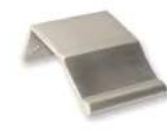

**Art.-Nr. 2005**  
Seite / page 40



**Art.-Nr. 1621**  
Seite / page 41

**Einlassbeschläge / Metall**  
**recessed handles metal**



**Art.-Nr. 2382**  
Seite / page 54



**Art.-Nr. 2231**  
Seite / page 66



**Art.-Nr. 2227**  
Seite / page 296



**Art.-Nr. 2159**  
Seite / page 74



**Art.-Nr. 2155**  
Seite / page 74



**Art.-Nr. 2152**  
Seite / page 74



**Art.-Nr. 2151**  
Seite / page 74



**Art.-Nr. 2042**  
Seite / page 74



**Art.-Nr. 1870**  
Seite / page 75



**Art.-Nr. 1597**  
Seite / page 116



**Art.-Nr. 1592**  
Seite / page 116

**Einlassbeschläge / Edelstahl**  
**recessed handles stainless steel**



**Art.-Nr. 2294**  
Seite / page 188



**Art.-Nr. 2293**  
Seite / page 188



**Art.-Nr. 2292**  
Seite / page 188



**Art.-Nr. 2291**  
Seite / page 188

**Einlassbeschläge / Kunststoff**  
**recessed handles plastic**



**Art.-Nr. 01045**  
Seite / page 206



**Art.-Nr. 01031**  
Seite / page 206



**Art.-Nr. 01028**  
Seite / page 206



**Art.-Nr. 0434**  
Seite / page 220



















































**Art.-Nr. 0428**  
Seite / page 221

**Einlassbeschläge / Holz**  
**recessed handles wood**



**Art.-Nr. S60**  
Seite / page 276

**Metall / Griffe**  
**metal / handle**

					
<b>Art.-Nr. 2458</b> Seite / page 42	<b>Art.-Nr. 2457</b> Seite / page 42	<b>Art.-Nr. 2448</b> Seite / page 43	<b>Art.-Nr. 2442</b> Seite / page 44	<b>Art.-Nr. 2441</b> Seite / page 44	<b>Art.-Nr. 2440</b> Seite / page 44
					
<b>Art.-Nr. 2439</b> Seite / page 45	<b>Art.-Nr. 2415</b> Seite / page 48	<b>Art.-Nr. 2414</b> Seite / page 48	<b>Art.-Nr. 2413</b> Seite / page 48	<b>Art.-Nr. 2412</b> Seite / page 50	<b>Art.-Nr. 2394</b> Seite / page 50
					
<b>Art.-Nr. 2392</b> Seite / page 50	<b>Art.-Nr. 2391</b> Seite / page 52	<b>Art.-Nr. 2388</b> Seite / page 52	<b>Art.-Nr. 2381</b> Seite / page 54	<b>Art.-Nr. 2374</b> Seite / page 56	<b>Art.-Nr. 2356</b> Seite / page 56
					
<b>Art.-Nr. 2350F</b> Seite / page 56	<b>Art.-Nr. 2343</b> Seite / page 58	<b>Art.-Nr. 2341</b> Seite / page 58	<b>Art.-Nr. 2340</b> Seite / page 58	<b>Art.-Nr. 2328</b> Seite / page 60	<b>Art.-Nr. 2318</b> Seite / page 60
					
<b>Art.-Nr. 2307</b> Seite / page 62	<b>Art.-Nr. 2306</b> Seite / page 62	<b>Art.-Nr. 2285</b> Seite / page 62	<b>Art.-Nr. 2284</b> Seite / page 64	<b>Art.-Nr. 2267</b> Seite / page 64	<b>Art.-Nr. 2266</b> Seite / page 64
					
<b>Art.-Nr. 2262</b> Seite / page 66	<b>Art.-Nr. 2261</b> Seite / page 66	<b>Art.-Nr. 2238</b> Seite / page 66	<b>Art.-Nr. 2237</b> Seite / page 66	<b>Art.-Nr. 2211</b> Seite / page 67	<b>Art.-Nr. 2210</b> Seite / page 67
					
<b>Art.-Nr. 2209</b> Seite / page 68	<b>Art.-Nr. 2208</b> Seite / page 68	<b>Art.-Nr. 2206</b> Seite / page 68	<b>Art.-Nr. 2204</b> Seite / page 68	<b>Art.-Nr. 2200</b> Seite / page 69	<b>Art.-Nr. 2199</b> Seite / page 69
					
<b>Art.-Nr. 2198</b> Seite / page 70	<b>Art.-Nr. 2197</b> Seite / page 70	<b>Art.-Nr. 2184</b> Seite / page 70	<b>Art.-Nr. 2183</b> Seite / page 70	<b>Art.-Nr. 2182</b> Seite / page 70	<b>Art.-Nr. 2170</b> Seite / page 71

## Artikelübersicht / overview items

					
<b>Art.-Nr. 2162</b> Seite / page 72	<b>Art.-Nr. 2161</b> Seite / page 72	<b>Art.-Nr. 2160</b> Seite / page 72	<b>Art.-Nr. 2157</b> Seite / page 73	<b>Art.-Nr. 2156</b> Seite / page 73	<b>Art.-Nr. 2136</b> Seite / page 73
					
<b>Art.-Nr. 2129</b> Seite / page 75	<b>Art.-Nr. 2120</b> Seite / page 75	<b>Art.-Nr. 2118</b> Seite / page 76	<b>Art.-Nr. 2116</b> Seite / page 76	<b>Art.-Nr. 2113</b> Seite / page 76	<b>Art.-Nr. 2112</b> Seite / page 76
					
<b>Art.-Nr. 2110</b> Seite / page 78	<b>Art.-Nr. 2108</b> Seite / page 78	<b>Art.-Nr. 2105</b> Seite / page 78	<b>Art.-Nr. 2096</b> Seite / page 80	<b>Art.-Nr. 2095</b> Seite / page 80	<b>Art.-Nr. 2094</b> Seite / page 80
					
<b>Art.-Nr. 2093</b> Seite / page 80	<b>Art.-Nr. 2092</b> Seite / page 80	<b>Art.-Nr. 2091</b> Seite / page 81	<b>Art.-Nr. 2090</b> Seite / page 79	<b>Art.-Nr. 2089</b> Seite / page 79	<b>Art.-Nr. 2086</b> Seite / page 82
					
<b>Art.-Nr. 2084</b> Seite / page 82	<b>Art.-Nr. 2082</b> Seite / page 82	<b>Art.-Nr. 2075</b> Seite / page 83	<b>Art.-Nr. 2073</b> Seite / page 83	<b>Art.-Nr. 2064</b> Seite / page 76	<b>Art.-Nr. 2063</b> Seite / page 77
					
<b>Art.-Nr. 2057</b> Seite / page 77	<b>Art.-Nr. 2053</b> Seite / page 77	<b>Art.-Nr. 2035</b> Seite / page 84	<b>Art.-Nr. 2033</b> Seite / page 84	<b>Art.-Nr. 2027</b> Seite / page 86	<b>Art.-Nr. 2026</b> Seite / page 86
					
<b>Art.-Nr. 2025</b> Seite / page 86	<b>Art.-Nr. 2024</b> Seite / page 86	<b>Art.-Nr. 2023</b> Seite / page 87	<b>Art.-Nr. 2021</b> Seite / page 88	<b>Art.-Nr. 2016</b> Seite / page 84	<b>Art.-Nr. 2014</b> Seite / page 88
					
<b>Art.-Nr. 2006</b> Seite / page 84	<b>Art.-Nr. 1987</b> Seite / page 90	<b>Art.-Nr. 1973</b> Seite / page 90	<b>Art.-Nr. 1970</b> Seite / page 91	<b>Art.-Nr. 1969</b> Seite / page 91	<b>Art.-Nr. 1968</b> Seite / page 91
					
<b>Art.-Nr. 1959</b> Seite / page 92	<b>Art.-Nr. 1957</b> Seite / page 92	<b>Art.-Nr. 1956</b> Seite / page 92	<b>Art.-Nr. 1935</b> Seite / page 93	<b>Art.-Nr. 1932</b> Seite / page 93	<b>Art.-Nr. 1920</b> Seite / page 94



## Artikelübersicht / overview items

					
<b>Art-Nr. 1918</b> Seite / page 94	<b>Art-Nr. 1916</b> Seite / page 94	<b>Art-Nr. 1908</b> Seite / page 96	<b>Art-Nr. 1906F</b> Seite / page 96	<b>Art-Nr. 1898</b> Seite / page 96	<b>Art-Nr. 1883</b> Seite / page 99
					
<b>Art-Nr. 1881</b> Seite / page 97	<b>Art-Nr. 1874</b> Seite / page 99	<b>Art-Nr. 1837</b> Seite / page 100	<b>Art-Nr. 1835</b> Seite / page 100	<b>Art-Nr. 1816</b> Seite / page 100	<b>Art-Nr. 1810</b> Seite / page 100
					
<b>Art-Nr. 1809</b> Seite / page 100	<b>Art-Nr. 1791</b> Seite / page 101	<b>Art-Nr. 1784</b> Seite / page 102	<b>Art-Nr. 1772</b> Seite / page 102	<b>Art-Nr. 1771</b> Seite / page 102	<b>Art-Nr. 1770</b> Seite / page 102
					
<b>Art-Nr. 1765</b> Seite / page 104	<b>Art-Nr. 1764</b> Seite / page 104	<b>Art-Nr. 1763</b> Seite / page 104	<b>Art-Nr. 1762</b> Seite / page 104	<b>Art-Nr. 1761</b> Seite / page 104	<b>Art-Nr. 1760</b> Seite / page 105
					
<b>Art-Nr. 1757</b> Seite / page 106	<b>Art-Nr. 1750</b> Seite / page 108	<b>Art-Nr. 1748</b> Seite / page 108	<b>Art-Nr. 1706</b> Seite / page 106	<b>Art-Nr. 1704</b> Seite / page 107	<b>Art-Nr. 1699</b> Seite / page 109
					
<b>Art-Nr. 1697</b> Seite / page 109	<b>Art-Nr. 1696</b> Seite / page 109	<b>Art-Nr. 1692</b> Seite / page 110	<b>Art-Nr. 1682</b> Seite / page 110	<b>Art-Nr. 1681</b> Seite / page 110	<b>Art-Nr. 1671</b> Seite / page 110
					
<b>Art-Nr. 1668</b> Seite / page 110	<b>Art-Nr. 1667</b> Seite / page 111	<b>Art-Nr. 1666</b> Seite / page 111	<b>Art-Nr. 1663</b> Seite / page 112	<b>Art-Nr. 1661</b> Seite / page 112	<b>Art-Nr. 1651</b> Seite / page 112
					
<b>Art-Nr. 1631</b> Seite / page 115	<b>Art-Nr. 1602</b> Seite / page 116	<b>Art-Nr. 1601</b> Seite / page 116	<b>Art-Nr. 1596</b> Seite / page 118	<b>Art-Nr. 1595</b> Seite / page 118	<b>Art-Nr. 1586</b> Seite / page 118
					
<b>Art-Nr. 1582</b> Seite / page 120	<b>Art-Nr. 1580</b> Seite / page 120	<b>Art-Nr. 1577</b> Seite / page 122	<b>Art-Nr. 1567</b> Seite / page 122	<b>Art-Nr. 1563</b> Seite / page 123	<b>Art-Nr. 1543</b> Seite / page 125

## Artikelübersicht / overview items

					
<b>Art-Nr. 1541</b> Seite / page 125	<b>Art-Nr. 1540</b> Seite / page 126	<b>Art-Nr. 1538</b> Seite / page 126	<b>Art-Nr. 1537</b> Seite / page 124	<b>Art-Nr. 1536</b> Seite / page 124	<b>Art-Nr. 1535</b> Seite / page 126
					
<b>Art-Nr. 1534</b> Seite / page 126	<b>Art-Nr. 1532</b> Seite / page 127	<b>Art-Nr. 1529</b> Seite / page 127	<b>Art-Nr. 1528</b> Seite / page 128	<b>Art-Nr. 1527</b> Seite / page 128	<b>Art-Nr. 1518</b> Seite / page 128
					
<b>Art-Nr. 1517</b> Seite / page 128	<b>Art-Nr. 1516</b> Seite / page 128	<b>Art-Nr. 1515</b> Seite / page 129	<b>Art-Nr. 1509</b> Seite / page 129	<b>Art-Nr. 1506</b> Seite / page 130	<b>Art-Nr. 1505</b> Seite / page 130
					
<b>Art-Nr. 1498</b> Seite / page 132	<b>Art-Nr. 1498</b> Seite / page 132	<b>Art-Nr. 1497</b> Seite / page 132	<b>Art-Nr. 1493</b> Seite / page 134	<b>Art-Nr. 1488</b> Seite / page 134	<b>Art-Nr. 1485</b> Seite / page 134
					
<b>Art-Nr. 1480</b> Seite / page 134	<b>Art-Nr. 1478</b> Seite / page 134	<b>Art-Nr. 1367</b> Seite / page 137	<b>Art-Nr. 1365</b> Seite / page 137	<b>Art-Nr. 1340</b> Seite / page 138	<b>Art-Nr. 1329</b> Seite / page 138
					
<b>Art-Nr. 1323</b> Seite / page 140	<b>Art-Nr. 1313</b> Seite / page 140	<b>Art-Nr. 1309</b> Seite / page 140	<b>Art-Nr. 1304</b> Seite / page 142	<b>Art-Nr. 1267</b> Seite / page 142	<b>Art-Nr. 1253</b> Seite / page 142
					
<b>Art-Nr. 1245</b> Seite / page 143	<b>Art-Nr. 1238</b> Seite / page 143	<b>Art-Nr. 1235</b> Seite / page 144	<b>Art-Nr. 1228</b> Seite / page 144	<b>Art-Nr. 1227</b> Seite / page 144	<b>Art-Nr. 1225</b> Seite / page 144
					
<b>Art-Nr. 1213</b> Seite / page 146	<b>Art-Nr. 1211</b> Seite / page 146	<b>Art-Nr. 1210</b> Seite / page 146	<b>Art-Nr. 1198</b> Seite / page 147	<b>Art-Nr. 1188</b> Seite / page 148	<b>Art-Nr. 1185</b> Seite / page 148
					
<b>Art-Nr. 1140</b> Seite / page 150	<b>Art-Nr. 1139</b> Seite / page 150	<b>Art-Nr. 1117</b> Seite / page 150	<b>Art-Nr. 1095</b> Seite / page 150	<b>Art-Nr. 1053</b> Seite / page 152	<b>Art-Nr. 1052</b> Seite / page 153

## Artikelübersicht / overview items

					
<b>Art-Nr. 1051</b> Seite / page 153	<b>Art-Nr. 1047</b> Seite / page 154	<b>Art-Nr. 1046</b> Seite / page 154	<b>Art-Nr. 1042</b> Seite / page 156	<b>Art-Nr. 1034</b> Seite / page 158	<b>Art-Nr. 1029</b> Seite / page 156
					
<b>Art-Nr. 1026</b> Seite / page 156	<b>Art-Nr. 1022</b> Seite / page 156	<b>Art-Nr. 1021</b> Seite / page 156	<b>Art-Nr. 1013</b> Seite / page 157	<b>Art-Nr. 1003</b> Seite / page 157	<b>Art-Nr. 1001</b> Seite / page 158
					
<b>Art-Nr. 1000</b> Seite / page 158	<b>Art-Nr. 940</b> Seite / page 158	<b>Art-Nr. 935</b> Seite / page 159	<b>Art-Nr. 930</b> Seite / page 160	<b>Art-Nr. 926</b> Seite / page 160	<b>Art-Nr. 925</b> Seite / page 160
					
<b>Art-Nr. 924</b> Seite / page 160	<b>Art-Nr. 923</b> Seite / page 161	<b>Art-Nr. 922</b> Seite / page 161	<b>Art-Nr. 921</b> Seite / page 161	<b>Art-Nr. 917</b> Seite / page 162	<b>Art-Nr. 916</b> Seite / page 162
					
<b>Art-Nr. 915</b> Seite / page 163	<b>Art-Nr. 914</b> Seite / page 163	<b>Art-Nr. 912</b> Seite / page 164	<b>Art-Nr. 911</b> Seite / page 164	<b>Art-Nr. 910</b> Seite / page 164	<b>Art-Nr. 909</b> Seite / page 164
					
<b>Art-Nr. 908</b> Seite / page 164	<b>Art-Nr. 885</b> Seite / page 165	<b>Art-Nr. 878</b> Seite / page 166	<b>Art-Nr. 869</b> Seite / page 166	<b>Art-Nr. 820</b> Seite / page 167	<b>Art-Nr. 816</b> Seite / page 168
					
<b>Art-Nr. 815</b> Seite / page 168	<b>Art-Nr. 812</b> Seite / page 168	<b>Art-Nr. 811</b> Seite / page 168	<b>Art-Nr. 809</b> Seite / page 170	<b>Art-Nr. 806</b> Seite / page 170	<b>Art-Nr. 805</b> Seite / page 170
					
<b>Art-Nr. 769</b> Seite / page 170	<b>Art-Nr. 764</b> Seite / page 171	<b>Art-Nr. 753</b> Seite / page 171	<b>Art-Nr. 742</b> Seite / page 172	<b>Art-Nr. 657</b> Seite / page 172	<b>Art-Nr. 563</b> Seite / page 176
					
<b>Art-Nr. 550</b> Seite / page 176	<b>Art-Nr. 531</b> Seite / page 177	<b>Art-Nr. 481</b> Seite / page 180	<b>Art-Nr. 479</b> Seite / page 180	<b>Art-Nr. 6300</b> Seite / page 175	<b>Art-Nr. 6211A</b> Seite / page 174

## Artikelübersicht / overview items



**Art-Nr. 6211**  
Seite / page 174



**Art-Nr. 6175**  
Seite / page 174

## Metall / Knöpfe metal / knobs



**Art-Nr. 2464**  
Seite / page 42



**Art-Nr. 2438**  
Seite / page 46



**Art-Nr. 2416**  
Seite / page 46



**Art-Nr. 2411**  
Seite / page 46



**Art-Nr. 2389**  
Seite / page 52



**Art-Nr. 2384**  
Seite / page 54



**Art-Nr. 2338**  
Seite / page 60



**Art-Nr. 2205**  
Seite / page 68



**Art-Nr. 2163**  
Seite / page 72



**Art-Nr. 2150**  
Seite / page 72



**Art-Nr. 2127**  
Seite / page 75



**Art-Nr. 2104**  
Seite / page 79



**Art-Nr. 2100**  
Seite / page 79



**Art-Nr. 2087F**  
Seite / page 81



**Art-Nr. 2076**  
Seite / page 82



**Art-Nr. 2074**  
Seite / page 83



**Art-Nr. 2039**  
Seite / page 82



**Art-Nr. 2032**  
Seite / page 84



**Art-Nr. 2029**  
Seite / page 85



**Art-Nr. 2028**  
Seite / page 85



**Art-Nr. 2015**  
Seite / page 85



**Art-Nr. 2013**  
Seite / page 88



**Art-Nr. 2011**  
Seite / page 88



**Art-Nr. 2010**  
Seite / page 88



**Art-Nr. 1986**  
Seite / page 90



**Art-Nr. 1972**  
Seite / page 90



**Art-Nr. 1971**  
Seite / page 90



**Art-Nr. 1960**  
Seite / page 92



**Art-Nr. 1958**  
Seite / page 92



**Art-Nr. 1919**  
Seite / page 94



**Art-Nr. 1917**  
Seite / page 94



**Art-Nr. 1897**  
Seite / page 96



**Art-Nr. 1896**  
Seite / page 96



**Art-Nr. 1889**  
Seite / page 97



**Art-Nr. 1888**  
Seite / page 98



**Art-Nr. 1887**  
Seite / page 98



**Art-Nr. 1886**  
Seite / page 98



**Art-Nr. 1885**  
Seite / page 98



**Art-Nr. 1884**  
Seite / page 98



**Art-Nr. 1882**  
Seite / page 99























































**Art-Nr. 1808**  
Seite / page 101



**Art-Nr. 1769**  
Seite / page 102

## Artikelübersicht / overview items

 <b>Art-Nr. 1768</b> Seite / page 103	 <b>Art-Nr. 1767</b> Seite / page 103	 <b>Art-Nr. 1766</b> Seite / page 103	 <b>Art-Nr. 1756</b> Seite / page 106	 <b>Art-Nr. 1746</b> Seite / page 108	 <b>Art-Nr. 1745</b> Seite / page 108
 <b>Art-Nr. 1709</b> Seite / page 106	 <b>Art-Nr. 1705</b> Seite / page 106	 <b>Art-Nr. 1702</b> Seite / page 107	 <b>Art-Nr. 1701</b> Seite / page 107	 <b>Art-Nr. 1700</b> Seite / page 108	 <b>Art-Nr. 1652</b> Seite / page 112
 <b>Art-Nr. 1636</b> Seite / page 114	 <b>Art-Nr. 1635</b> Seite / page 114	 <b>Art-Nr. 1634</b> Seite / page 114	 <b>Art-Nr. 1633</b> Seite / page 114	 <b>Art-Nr. 1632</b> Seite / page 114	 <b>Art-Nr. 1624</b> Seite / page 112
 <b>Art-Nr. 1600</b> Seite / page 116	 <b>Art-Nr. 1588</b> Seite / page 118	 <b>Art-Nr. 1587</b> Seite / page 118	 <b>Art-Nr. 1583</b> Seite / page 120	 <b>Art-Nr. 1581</b> Seite / page 120	 <b>Art-Nr. 1579</b> Seite / page 122
 <b>Art-Nr. 1578</b> Seite / page 122	 <b>Art-Nr. 1576</b> Seite / page 122	 <b>Art-Nr. 1549</b> Seite / page 124	 <b>Art-Nr. 1548</b> Seite / page 124	 <b>Art-Nr. 1546</b> Seite / page 124	 <b>Art-Nr. 1542</b> Seite / page 125
 <b>Art-Nr. 1533</b> Seite / page 126	 <b>Art-Nr. 1503</b> Seite / page 130	 <b>Art-Nr. 1502</b> Seite / page 132	 <b>Art-Nr. 1500</b> Seite / page 132	 <b>Art-Nr. 1499</b> Seite / page 132	 <b>Art-Nr. 1474</b> Seite / page 135
 <b>Art-Nr. 1427</b> Seite / page 136	 <b>Art-Nr. 1426</b> Seite / page 136	 <b>Art-Nr. 1425</b> Seite / page 136	 <b>Art-Nr. 1424</b> Seite / page 136	 <b>Art-Nr. 1368</b> Seite / page 136	 <b>Art-Nr. 1366</b> Seite / page 137
 <b>Art-Nr. 1349</b> Seite / page 138	 <b>Art-Nr. 1339</b> Seite / page 138	 <b>Art-Nr. 1332</b> Seite / page 138	 <b>Art-Nr. 1324</b> Seite / page 139	 <b>Art-Nr. 1315</b> Seite / page 146	 <b>Art-Nr. 1314</b> Seite / page 140
 <b>Art-Nr. 1310</b> Seite / page 140	 <b>Art-Nr. 1303</b> Seite / page 142	 <b>Art-Nr. 1268</b> Seite / page 142	 <b>Art-Nr. 1223</b> Seite / page 144	 <b>Art-Nr. 1209</b> Seite / page 146	 <b>Art-Nr. 1208</b> Seite / page 147

## Artikelübersicht / overview items



**Art-Nr. 1207**  
Seite / page 147



**Art-Nr. 1195**  
Seite / page 148



**Art-Nr. 1183**  
Seite / page 148



**Art-Nr. 1180**  
Seite / page 148



**Art-Nr. 1126**  
Seite / page 150



**Art-Nr. 1082**  
Seite / page 149



**Art-Nr. 1075**  
Seite / page 149



**Art-Nr. 1072**  
Seite / page 149



**Art-Nr. 1059**  
Seite / page 152



**Art-Nr. 1058**  
Seite / page 152



**Art-Nr. 1057**  
Seite / page 152



**Art-Nr. 1056**  
Seite / page 152



**Art-Nr. 1049**  
Seite / page 154



**Art-Nr. 1048**  
Seite / page 154



**Art-Nr. 1045**  
Seite / page 154



**Art-Nr. 1044**  
Seite / page 155



**Art-Nr. 939**  
Seite / page 158



**Art-Nr. 933**  
Seite / page 159



**Art-Nr. 932**  
Seite / page 159



**Art-Nr. 920**  
Seite / page 162



**Art-Nr. 919**  
Seite / page 162



**Art-Nr. 918**  
Seite / page 162



**Art-Nr. 913**  
Seite / page 163



**Art-Nr. 873**  
Seite / page 166



**Art-Nr. 872**  
Seite / page 166



**Art-Nr. 871**  
Seite / page 166



**Art-Nr. 819**  
Seite / page 167



**Art-Nr. 818**  
Seite / page 168



**Art-Nr. 795**  
Seite / page 170



**Art-Nr. 646**  
Seite / page 172



**Art-Nr. 641**  
Seite / page 172



**Art-Nr. 640**  
Seite / page 172



**Art-Nr. 639**  
Seite / page 173



**Art-Nr. 565**  
Seite / page 176



**Art-Nr. 564**  
Seite / page 176



**Art-Nr. 549**  
Seite / page 176



**Art-Nr. 527**  
Seite / page 177



**Art-Nr. 523**  
Seite / page 177



**Art-Nr. 522**  
Seite / page 178



**Art-Nr. 494**  
Seite / page 178



**Art-Nr. 490**  
Seite / page 178



**Art-Nr. 489**  
Seite / page 178



**Art-Nr. 487**  
Seite / page 178



**Art-Nr. 423**  
Seite / page 180



**Art-Nr. 398**  
Seite / page 180



**Art-Nr. 397**  
Seite / page 180



**Art-Nr. 392**  
Seite / page 181



**Art-Nr. 365**  
Seite / page 182



**Art-Nr. 364**  
Seite / page 182



**Art-Nr. 361**  
Seite / page 182



**Art-Nr. 357**  
Seite / page 182



**Art-Nr. 356**  
Seite / page 182

**Metall / Haken**  
**metal / hooks**



**Art.-Nr. 2463**  
Seite / page 290



**Art.-Nr. 2462**  
Seite / page 290



**Art.-Nr. 2453**  
Seite / page 290



**Art.-Nr. 2435**  
Seite / page 292



**Art.-Nr. 2434**  
Seite / page 292



**Art.-Nr. 2433**  
Seite / page 294



**Art.-Nr. 2432**  
Seite / page 294



**Art.-Nr. 2422**  
Seite / page 386



**Art.-Nr. 2377**  
Seite / page 292



**Art.-Nr. 2363**  
Seite / page 298



**Art.-Nr. 2355**  
Seite / page 294



**Art.-Nr. 2326**  
Seite / page 300



**Art.-Nr. 2325**  
Seite / page 300



**Art.-Nr. 2324**  
Seite / page 300



**Art.-Nr. 2314**  
Seite / page 300



**Art.-Nr. 2313**  
Seite / page 300



**Art.-Nr. 2295**  
Seite / page 296



**Art.-Nr. 2287**  
Seite / page 301



**Art.-Nr. 2234**  
Seite / page 296



**Art.-Nr. 2214**  
Seite / page 301



**Art.-Nr. 2213**  
Seite / page 301



**Art.-Nr. 2177**  
Seite / page 302



**Art.-Nr. 2107**  
Seite / page 302



**Art.-Nr. 2081DM**  
Seite / page 302, 364



**Art.-Nr. 2081**  
Seite / page 302, 364



**Art.-Nr. 2052**  
Seite / page 302



**Art.-Nr. 2051**  
Seite / page 303



**Art.-Nr. 2050**  
Seite / page 303



**Art.-Nr. 2020**  
Seite / page 304



**Art.-Nr. 2019**  
Seite / page 304



**Art.-Nr. 1982**  
Seite / page 304



**Art.-Nr. 1981**  
Seite / page 304



**Art.-Nr. 1980**  
Seite / page 304



**Art.-Nr. 1979**  
Seite / page 305



**Art.-Nr. 1938**  
Seite / page 306



**Art.-Nr. 1871**  
Seite / page 306



**Art.-Nr. 1821**  
Seite / page 306



**Art.-Nr. 1789**  
Seite / page 308



**Art.-Nr. 1788**  
Seite / page 308



**Art.-Nr. 1787**  
Seite / page 308



**Art.-Nr. 1786**  
Seite / page 306



**Art.-Nr. 1785**  
Seite / page 306



**Art.-Nr. 1747**  
Seite / page 308



**Art.-Nr. 1672**  
Seite / page 308



**Art.-Nr. 1670**  
Seite / page 310



**Art.-Nr. 1669**  
Seite / page 310

























































**Art.-Nr. 1654**  
Seite / page 310

































**Art.-Nr. 1653**  
Seite / page 310

## Artikelübersicht / overview items

					
<b>Art-Nr. 1607</b> Seite / page 310	<b>Art-Nr. 1606</b> Seite / page 311	<b>Art-Nr. 1605</b> Seite / page 311	<b>Art-Nr. 1604</b> Seite / page 311	<b>Art-Nr. 1463</b> Seite / page 311	<b>Art-Nr. 1427</b> Seite / page 312
					
<b>Art-Nr. 1426</b> Seite / page 312	<b>Art-Nr. 1425</b> Seite / page 312	<b>Art-Nr. 1424</b> Seite / page 312	<b>Art-Nr. 1421</b> Seite / page 312	<b>Art-Nr. 1420</b> Seite / page 313	<b>Art-Nr. 1354</b> Seite / page 314
					
<b>Art-Nr. 1353</b> Seite / page 314	<b>Art-Nr. 1322</b> Seite / page 314	<b>Art-Nr. 1321</b> Seite / page 314	<b>Art-Nr. 1294</b> Seite / page 314	<b>Art-Nr. 1293</b> Seite / page 315	<b>Art-Nr. 1292</b> Seite / page 315
					
<b>Art-Nr. 1281</b> Seite / page 316	<b>Art-Nr. 1280</b> Seite / page 316	<b>Art-Nr. 1279</b> Seite / page 316	<b>Art-Nr. 1278</b> Seite / page 316	<b>Art-Nr. 1277</b> Seite / page 316	<b>Art-Nr. 1265</b> Seite / page 317
					
<b>Art-Nr. 1241</b> Seite / page 318	<b>Art-Nr. 1237</b> Seite / page 317	<b>Art-Nr. 1236</b> Seite / page 317	<b>Art-Nr. 1232</b> Seite / page 318	<b>Art-Nr. 1230</b> Seite / page 318	<b>Art-Nr. 1220</b> Seite / page 318
					
<b>Art-Nr. 1218</b> Seite / page 318	<b>Art-Nr. 1217</b> Seite / page 319	<b>Art-Nr. 1142</b> Seite / page 298	<b>Art-Nr. 1141</b> Seite / page 298	<b>Art-Nr. 1138</b> Seite / page 320	<b>Art-Nr. 1137</b> Seite / page 320
					
<b>Art-Nr. 1136</b> Seite / page 320	<b>Art-Nr. 1134</b> Seite / page 320	<b>Art-Nr. 1133</b> Seite / page 320	<b>Art-Nr. 1132</b> Seite / page 321	<b>Art-Nr. 1131</b> Seite / page 321	<b>Art-Nr. 1116</b> Seite / page 322
					
<b>Art-Nr. 1115</b> Seite / page 322	<b>Art-Nr. 1098</b> Seite / page 322	<b>Art-Nr. 1097</b> Seite / page 322	<b>Art-Nr. 1096</b> Seite / page 322	<b>Art-Nr. 1083</b> Seite / page 348	<b>Art-Nr. 1076</b> Seite / page 348
					
<b>Art-Nr. 1071</b> Seite / page 348	<b>Art-Nr. 1064</b> Seite / page 323	<b>Art-Nr. 851</b> Seite / page 323	<b>Art-Nr. 817</b> Seite / page 323	<b>Art-Nr. 748</b> Seite / page 324	<b>Art-Nr. 746</b> Seite / page 324



## Artikelübersicht / overview items

					
<b>Art.-Nr. 745</b> Seite / page 324	<b>Art.-Nr. 744</b> Seite / page 348	<b>Art.-Nr. 743</b> Seite / page 324, 355	<b>Art.-Nr. 704</b> Seite / page 324	<b>Art.-Nr. 703</b> Seite / page 325	<b>Art.-Nr. 606</b> Seite / page 299
					
<b>Art.-Nr. 605</b> Seite / page 299	<b>Art.-Nr. 584</b> Seite / page 348	<b>Art.-Nr. 583</b> Seite / page 326	<b>Art.-Nr. 582</b> Seite / page 326	<b>Art.-Nr. 581</b> Seite / page 326	<b>Art.-Nr. 580</b> Seite / page 326
					
<b>Art.-Nr. 579</b> Seite / page 349	<b>Art.-Nr. 577</b> Seite / page 349	<b>Art.-Nr. 575</b> Seite / page 349	<b>Art.-Nr. 558</b> Seite / page 326	<b>Art.-Nr. 557</b> Seite / page 327	<b>Art.-Nr. 554</b> Seite / page 328
					
<b>Art.-Nr. 553</b> Seite / page 328	<b>Art.-Nr. 548</b> Seite / page 328	<b>Art.-Nr. 547</b> Seite / page 328	<b>Art.-Nr. 507</b> Seite / page 328	<b>Art.-Nr. 506</b> Seite / page 329	<b>Art.-Nr. 505</b> Seite / page 329
					
<b>Art.-Nr. 504</b> Seite / page 329	<b>Art.-Nr. 431</b> Seite / page 330	<b>Art.-Nr. 430</b> Seite / page 330	<b>Art.-Nr. 418</b> Seite / page 330	<b>Art.-Nr. 328</b> Seite / page 330	<b>Art.-Nr. 327</b> Seite / page 330

## Edelstahl / Griffe stainless steel / handles

					
<b>Art.-Nr. 2423H</b> Seite / page 186	<b>Art.-Nr. 2387H</b> Seite / page 186	<b>Art.-Nr. 2308H</b> Seite / page 188	<b>Art.-Nr. 2188H</b> Seite / page 190	<b>Art.-Nr. 1739</b> Seite / page 190	<b>Art.-Nr. 1660</b> Seite / page 190
					
<b>Art.-Nr. 1613</b> Seite / page 192	<b>Art.-Nr. 1585</b> Seite / page 192	<b>Art.-Nr. 1531</b> Seite / page 192	<b>Art.-Nr. 1530</b> Seite / page 193	<b>Art.-Nr. 1472</b> Seite / page 194	<b>Art.-Nr. 1471</b> Seite / page 194
					
<b>Art.-Nr. 1408</b> Seite / page 194	<b>Art.-Nr. 1407</b> Seite / page 194	<b>Art.-Nr. 1406</b> Seite / page 195	<b>Art.-Nr. 1406H</b> Seite / page 195	<b>Art.-Nr. 1405</b> Seite / page 195	<b>Art.-Nr. 906</b> Seite / page 196, 203

## Artikelübersicht / overview items



**Art.-Nr. 903**  
Seite / page 197



**Art.-Nr. 901**  
Seite / page 198



**Art.-Nr. 900**  
Seite / page 198



**Art.-Nr. 897**  
Seite / page 198

## Edelstahl / Knöpfe stainless steel / knobs



**Art.-Nr. 2419**  
Seite / page 186



**Art.-Nr. 2280**  
Seite / page 189



**Art.-Nr. 2279**  
Seite / page 189



**Art.-Nr. 2277**  
Seite / page 189



**Art.-Nr. 2275**  
Seite / page 189



**Art.-Nr. 1659**  
Seite / page 190



**Art.-Nr. 1628**  
Seite / page 190



**Art.-Nr. 1612**  
Seite / page 192



**Art.-Nr. 1611**  
Seite / page 192



**Art.-Nr. 1404**  
Seite / page 196



**Art.-Nr. 1403**  
Seite / page 196



**Art.-Nr. 1402**  
Seite / page 196



**Art.-Nr. 904**  
Seite / page 196



**Art.-Nr. 902**  
Seite / page 197



**Art.-Nr. 898**  
Seite / page 198



**Art.-Nr. 795**  
Seite / page 198

## Edelstahl / Haken stainless steel / hooks



**Art.-Nr. 2418**  
Seite / page 332



**Art.-Nr. 2403**  
Seite / page 332



**Art.-Nr. 2360**  
Seite / page 332



**Art.-Nr. 2337**  
Seite / page 298



**Art.-Nr. 2336**  
Seite / page 298



**Art.-Nr. 2316**  
Seite / page 334



**Art.-Nr. 2315**  
Seite / page 334



**Art.-Nr. 2302**  
Seite / page 334



**Art.-Nr. 2301**  
Seite / page 334



**Art.-Nr. 2286**  
Seite / page 334



**Art.-Nr. 2283**  
Seite / page 335



**Art.-Nr. 2282**  
Seite / page 335



**Art.-Nr. 2259**  
Seite / page 336



**Art.-Nr. 2258**  
Seite / page 336



**Art.-Nr. 2236F**  
Seite / page 296, 388



**Art.-Nr. 2235F**  
Seite / page 296, 388



**Art.-Nr. 2106**  
Seite / page 336



**Art.-Nr. 1825**  
Seite / page 336

## Artikelübersicht / overview items



**Art.-Nr. 1824**  
Seite / page 336



**Art.-Nr. 1658**  
Seite / page 337



**Art.-Nr. 1401**  
Seite / page 337



**Art.-Nr. 1400**  
Seite / page 337

## Special Edition mit Swarovski Elements / Griffe special edition with Swarovski elements / handles



**Art.-Nr. 2198**  
Seite / page 202



**Art.-Nr. 2197**  
Seite / page 202



**Art.-Nr. 2108**  
Seite / page 202



**Art.-Nr. 2053**  
Seite / page 202



**Art.-Nr. 2038**  
Seite / page 203



**Art.-Nr. 2027**  
Seite / page 203



**Art.-Nr. 906**  
Seite / page 203

## Special Edition mit Swarovski Elements /Knöpfe special edition with Swarovski elements



**Art.-Nr. 2040**  
Seite / page 202



**Art.-Nr. 2037**  
Seite / page 203



**Art.-Nr. 2036**  
Seite / page 203

## Kunststoff / Griffe plastic / handles



**Art.-Nr. 01061**  
Seite / page 208



**Art.-Nr. 01060**  
Seite / page 208



**Art.-Nr. 01057**  
Seite / page 208



**Art.-Nr. 01055**  
Seite / page 208



**Art.-Nr. 01011**  
Seite / page 210



**Art.-Nr. 01006**  
Seite / page 210



**Art.-Nr. 0976**  
Seite / page 210



**Art.-Nr. 0952**  
Seite / page 210



**Art.-Nr. 0951**  
Seite / page 211



**Art.-Nr. 0839**  
Seite / page 212















































**Art.-Nr. 0824**  
Seite / page 212

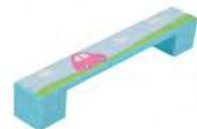

**Art.-Nr. 0819**  
Seite / page 212

## Artikelübersicht / overview items

					
<b>Art.-Nr. 0771</b> Seite / page 212	<b>Art.-Nr. 0753</b> Seite / page 213	<b>Art.-Nr. 0715</b> Seite / page 214	<b>Art.-Nr. 0653</b> Seite / page 214	<b>Art.-Nr. 0618</b> Seite / page 215	<b>Art.-Nr. 0606</b> Seite / page 216
					
<b>Art.-Nr. 0602</b> Seite / page 216	<b>Art.-Nr. 0571</b> Seite / page 216	<b>Art.-Nr. 0563</b> Seite / page 216	<b>Art.-Nr. 0556</b> Seite / page 216	<b>Art.-Nr. 0549</b> Seite / page 218	<b>Art.-Nr. 0540</b> Seite / page 218
					
<b>Art.-Nr. 0511</b> Seite / page 219	<b>Art.-Nr. 0443H</b> Seite / page 220	<b>Art.-Nr. 0436</b> Seite / page 220	<b>Art.-Nr. 0387</b> Seite / page 221	<b>Art.-Nr. 0364</b> Seite / page 222	<b>Art.-Nr. 0297</b> Seite / page 222
					
<b>Art.-Nr. 0287</b> Seite / page 223	<b>Art.-Nr. A549</b> Seite / page 218	<b>Art.-Nr. H197</b> Seite / page 232	<b>Art.-Nr. H121</b> Seite / page 232	<b>Art.-Nr. M618</b> Seite / page 215	<b>Art.-Nr. M549</b> Seite / page 218
					
<b>Art.-Nr. SM8196F</b> Seite / page 250	<b>Art.-Nr. SM8189I</b> Seite / page 250	<b>Art.-Nr. SM8187I</b> Seite / page 250	<b>Art.-Nr. SM8137F</b> Seite / page 252	<b>Art.-Nr. SM8119I</b> Seite / page 252	<b>Art.-Nr. SM8111</b> Seite / page 254
					
<b>Art.-Nr. SM8105I</b> Seite / page 254	<b>Art.-Nr. SM8104</b> Seite / page 254	<b>Art.-Nr. SM8103</b> Seite / page 254	<b>Art.-Nr. SM8095</b> Seite / page 254	<b>Art.-Nr. SM8094I</b> Seite / page 255	<b>Art.-Nr. SM8086</b> Seite / page 255
					
<b>Art.-Nr. SM8059I</b> Seite / page 256, 263	<b>Art.-Nr. SM8021</b> Seite / page 256	<b>Art.-Nr. SM8014I</b> Seite / page 256	<b>Art.-Nr. SM8004F</b> Seite / page 252	<b>Art.-Nr. SM8004I</b> Seite / page 252	<b>Art.-Nr. SM8004</b> Seite / page 256
					
<b>Art.-Nr. SM083I</b> Seite / page 258	<b>Art.-Nr. SM050</b> Seite / page 259	<b>Art.-Nr. SM043</b> Seite / page 259			

**Kunststoff / Knöpfe**  
**plastic / knobs**

					
<b>Art.-Nr. 01056</b> Seite / page 208	<b>Art.-Nr. 01023</b> Seite / page 210	<b>Art.-Nr. 0903</b> Seite / page 240	<b>Art.-Nr. 0902</b> Seite / page 240	<b>Art.-Nr. 0823</b> Seite / page 212	<b>Art.-Nr. 0765</b> Seite / page 213
					
<b>Art.-Nr. 0706</b> Seite / page 214	<b>Art.-Nr. 0695</b> Seite / page 214	<b>Art.-Nr. 0621</b> Seite / page 214	<b>Art.-Nr. 0619</b> Seite / page 215	<b>Art.-Nr. 0551</b> Seite / page 217	<b>Art.-Nr. 0516</b> Seite / page 218
					
<b>Art.-Nr. 0506</b> Seite / page 219	<b>Art.-Nr. 0503</b> Seite / page 219	<b>Art.-Nr. 0475H</b> Seite / page 220	<b>Art.-Nr. 0453</b> Seite / page 220	<b>Art.-Nr. 0391</b> Seite / page 221	<b>Art.-Nr. 0385</b> Seite / page 222
					
<b>Art.-Nr. 0294</b> Seite / page 222	<b>Art.-Nr. 0291</b> Seite / page 223	<b>Art.-Nr. 0192</b> Seite / page 223	<b>Art.-Nr. 0104</b> Seite / page 223	<b>Art.-Nr. H243</b> Seite / page 224	<b>Art.-Nr. H242</b> Seite / page 224
					
<b>Art.-Nr. H241</b> Seite / page 224	<b>Art.-Nr. H235</b> Seite / page 226	<b>Art.-Nr. H234</b> Seite / page 224	<b>Art.-Nr. H233</b> Seite / page 225	<b>Art.-Nr. H210R</b> Seite / page 226	<b>Art.-Nr. H210L</b> Seite / page 226
					
<b>Art.-Nr. H159</b> Seite / page 226	<b>Art.-Nr. H158</b> Seite / page 226	<b>Art.-Nr. H157</b> Seite / page 226	<b>Art.-Nr. H156</b> Seite / page 227	<b>Art.-Nr. H152</b> Seite / page 227	<b>Art.-Nr. H150</b> Seite / page 228
					
<b>Art.-Nr. H149</b> Seite / page 228	<b>Art.-Nr. H148</b> Seite / page 228	<b>Art.-Nr. H147</b> Seite / page 228	<b>Art.-Nr. H144</b> Seite / page 230	<b>Art.-Nr. H143</b> Seite / page 230	<b>Art.-Nr. H138</b> Seite / page 236
					
<b>Art.-Nr. H135</b> Seite / page 236	<b>Art.-Nr. H127</b> Seite / page 230	<b>Art.-Nr. H126</b> Seite / page 230	<b>Art.-Nr. H125</b> Seite / page 230	<b>Art.-Nr. H124</b> Seite / page 231	<b>Art.-Nr. H123</b> Seite / page 231

## Artikelübersicht / overview items



**Art.-Nr. H122**  
Seite / page 231



**Art.-Nr. H119**  
Seite / page 232



**Art.-Nr. H118**  
Seite / page 232



**Art.-Nr. H117**  
Seite / page 232



**Art.-Nr. H110**  
Seite / page 234



**Art.-Nr. H109**  
Seite / page 234



**Art.-Nr. H108**  
Seite / page 234



**Art.-Nr. H107**  
Seite / page 234



**Art.-Nr. H106**  
Seite / page 234



**Art.-Nr. H105**  
Seite / page 235



**Art.-Nr. H104**  
Seite / page 238



**Art.-Nr. H101**  
Seite / page 238



**Art.-Nr. H100**  
Seite / page 238



**Art.-Nr. H099**  
Seite / page 238



**Art.-Nr. H087**  
Seite / page 236



**Art.-Nr. H086**  
Seite / page 236



**Art.-Nr. H085**  
Seite / page 236



**Art.-Nr. H084**  
Seite / page 237



**Art.-Nr. H083**  
Seite / page 237



**Art.-Nr. H082**  
Seite / page 238



**Art.-Nr. H078**  
Seite / page 240



**Art.-Nr. H072**  
Seite / page 228



**Art.-Nr. H068**  
Seite / page 242



**Art.-Nr. H067**  
Seite / page 242



**Art.-Nr. H065**  
Seite / page 242



**Art.-Nr. H064**  
Seite / page 242



**Art.-Nr. H061**  
Seite / page 242



**Art.-Nr. H060**  
Seite / page 243



**Art.-Nr. H050**  
Seite / page 244



**Art.-Nr. H049**  
Seite / page 244



**Art.-Nr. H048**  
Seite / page 244



**Art.-Nr. H047**  
Seite / page 244



**Art.-Nr. H046**  
Seite / page 244



**Art.-Nr. H045**  
Seite / page 246



**Art.-Nr. H044**  
Seite / page 246



**Art.-Nr. H043**  
Seite / page 246



**Art.-Nr. H042**  
Seite / page 246



**Art.-Nr. H041**  
Seite / page 246



**Art.-Nr. H040**  
Seite / page 247



**Art.-Nr. H039**  
Seite / page 247



**Art.-Nr. H030**  
Seite / page 248



**Art.-Nr. H029**  
Seite / page 248



**Art.-Nr. H028**  
Seite / page 248



**Art.-Nr. H027**  
Seite / page 248



**Art.-Nr. H026**  
Seite / page 248



**Art.-Nr. H025**  
Seite / page 249



**Art.-Nr. H024**  
Seite / page 249



**Art.-Nr. H023**  
Seite / page 249



**Art.-Nr. H022**  
Seite / page 249



**Art.-Nr. SM8257F**  
Seite / page 252



**Art.-Nr. SM8195I**  
Seite / page 250



**Art.-Nr. SM8194I**  
Seite / page 250



**Art.-Nr. SM8118I**  
Seite / page 252



**Art.-Nr. SM8117I**  
Seite / page 253

## Artikelübersicht / overview items



**Art.-Nr. SM8116I**  
Seite / page 253



**Art.-Nr. SM8066I**  
Seite / page 256



**Art.-Nr. SM873**  
Seite / page 258



**Art.-Nr. SM447**  
Seite / page 258



**Art.-Nr. SM440**  
Seite / page 258

**Art.-Nr. SM009**  
Seite / page 259



**Art.-Nr. SM009**  
Seite / page 259



## Kunststoff / Haken plastic / hooks



**Art.-Nr. 01040**  
Seite / page 338



**Art.-Nr. 01020**  
Seite / page 338



**Art.-Nr. 01019**  
Seite / page 338



**Art.-Nr. 01018**  
Seite / page 338



**Art.-Nr. 0859**  
Seite / page 338



**Art.-Nr. 0858**  
Seite / page 339



**Art.-Nr. 0853**  
Seite / page 339



**Art.-Nr. 0617**  
Seite / page 340



**Art.-Nr. 0616**  
Seite / page 340



**Art.-Nr. 0488**  
Seite / page 340



**Art.-Nr. 0487**  
Seite / page 340



**Art.-Nr. 0417**  
Seite / page 340



**Art.-Nr. 0416**  
Seite / page 341



**Art.-Nr. 0292**  
Seite / page 341



**Art.-Nr. H200**  
Seite / page 299



**Art.-Nr. H195**  
Seite / page 342



**Art.-Nr. H194**  
Seite / page 342



**Art.-Nr. H111**  
Seite / page 342



**Art.-Nr. H033**  
Seite / page 342



**Art.-Nr. H008**  
Seite / page 342



**Art.-Nr. H007**  
Seite / page 343



**Art.-Nr. M1687**  
Seite / page 382



**Art.-Nr. SM8252**  
Seite / page 343

## Kunstleder / Griffe imitation leather / handles



**Art.-Nr. H191**  
Seite / page 262



**Art.-Nr. H170**  
Seite / page 262



**Art.-Nr. LE004**  
Seite / page 262



**Art.-Nr. LE005**  
Seite / page 262



**Art.-Nr. SM8137F**  
Seite / page 262



**Art.-Nr. SM8121I**  
Seite / page 263



**Art.-Nr. SM8077F**  
Seite / page 263



**Art.-Nr. SM8064I**  
Seite / page 263



**Art.-Nr. SM8059I**  
Seite / page 256, 263

**Keramik / Knöpfe**  
**ceramic / knobs**



**Art.-Nr. SP81**  
Seite / page 266



**Art.-Nr. SP76**  
Seite / page 266



**Art.-Nr. SP69**  
Seite / page 266



**Art.-Nr. SP68**  
Seite / page 356



**Art.-Nr. SP65**  
Seite / page 266



**Art.-Nr. SP61**  
Seite / page 266



**Art.-Nr. SP60**  
Seite / page 267



**Art.-Nr. SP59**  
Seite / page 268



**Art.-Nr. SP58**  
Seite / page 268



**Art.-Nr. SP57**  
Seite / page 268



**Art.-Nr. SP56**  
Seite / page 268



**Art.-Nr. SP55**  
Seite / page 268



**Art.-Nr. SP54**  
Seite / page 269



**Art.-Nr. SP51**  
Seite / page 269



**Art.-Nr. SP46**  
Seite / page 270



**Art.-Nr. SP44**  
Seite / page 270



**Art.-Nr. SP43**  
Seite / page 270



**Art.-Nr. SP36**  
Seite / page 270



**Art.-Nr. SP8**  
Seite / page 270



**Art.-Nr. SP7**  
Seite / page 271



**Art.-Nr. SP6**  
Seite / page 272



**Art.-Nr. SP5**  
Seite / page 272



**Art.-Nr. SP1**  
Seite / page 272



**Art.-Nr. TR01**  
Seite / page 272



**Art.-Nr. TR02**  
Seite / page 272

**Holz / Griffe**  
**wood / handles**



**Art.-Nr. S669**  
Seite / page 276



**Art.-Nr. S653A**  
Seite / page 278



**Art.-Nr. S652A**  
Seite / page 278



**Art.-Nr. S647A**  
Seite / page 279



**Art.-Nr. S351**  
Seite / page 282



**Art.-Nr. S301**  
Seite / page 282



**Art.-Nr. S251**  
Seite / page 282



**Art.-Nr. S251A**  
Seite / page 282



**Art.-Nr. S231**  
Seite / page 283



**Art.-Nr. S120**  
Seite / page 284



**Art.-Nr. S113**  
Seite / page 285



**Art.-Nr. S50A**  
Seite / page 286



## Artikelübersicht / overview items



**Art.-Nr. S50**  
Seite / page 286



**Art.-Nr. S30A**  
Seite / page 287



**Art.-Nr. S30**  
Seite / page 287



**Art.-Nr. G18**  
Seite / page 276



**Art.-Nr. G17**  
Seite / page 276

## Holz / Knöpfe wood / knobs



**Art.-Nr. S657**  
Seite / page 278



**Art.-Nr. S656**  
Seite / page 278



**Art.-Nr. S655**  
Seite / page 278



**Art.-Nr. S638**  
Seite / page 280



**Art.-Nr. S637A**  
Seite / page 280



**Art.-Nr. S424**  
Seite / page 280



**Art.-Nr. S423A**  
Seite / page 280



**Art.-Nr. S423**  
Seite / page 280



**Art.-Nr. S367**  
Seite / page 281



**Art.-Nr. S358A**  
Seite / page 281



**Art.-Nr. S358**  
Seite / page 281



**Art.-Nr. S300**  
Seite / page 282



**Art.-Nr. S229**  
Seite / page 284



**Art.-Nr. S217**  
Seite / page 284



**Art.-Nr. S177**  
Seite / page 284



**Art.-Nr. S157**  
Seite / page 284



**Art.-Nr. S87A**  
Seite / page 285



**Art.-Nr. S87**  
Seite / page 285



**Art.-Nr. S70A**  
Seite / page 286



**Art.-Nr. S70**  
Seite / page 286



**Art.-Nr. L32**  
Seite / page 276

## Holz / Haken wood / hooks



**Art.-Nr. S156**  
Seite / page 344



**Art.-Nr. S155**  
Seite / page 344



**Art.-Nr. S154**  
Seite / page 344



**Art.-Nr. S121**  
Seite / page 345



**Art.-Nr. S109**  
Seite / page 345



**Art.-Nr. L150**  
Seite / page 344



**Art.-Nr. L36**  
Seite / page 344

**Haken und Hakenleisten selbstklebend**  
**hooks and hookrails self-adhesive**

**Metall**  
**metal**



**Art-Nr. 2335**  
 Seite / page 352



**Art-Nr. 2334**  
 Seite / page 252



**Art-Nr. 2333**  
 Seite / page 252



**Art-Nr. 2332**  
 Seite / page 2352



**Art-Nr. 2331**  
 Seite / page 352



**Art-Nr. 2330**  
 Seite / page 353



**Art-Nr. 2322**  
 Seite / page 254



**Art-Nr. 2321**  
 Seite / page 354



**Art-Nr. 2320**  
 Seite / page 354



**Art-Nr. 2319**  
 Seite / page 354



**Art-Nr. 2303**  
 Seite / page 355



**Art-Nr. 2178**  
 Seite / page 354, 355



**Art-Nr. 2178**  
 Seite / page 354, 355



**Art-Nr. 743**  
 Seite / page 324, 355

**Kunststoff**  
**plastic**



**Art-Nr. H214**  
 Seite / page 356



**Art-Nr. H199**  
 Seite / page 356



**Art-Nr. H198**  
 Seite / page 256



**Art-Nr. H114**  
 Seite / page 356

**Keramik**  
**ceramic**



**Art-Nr. SP68**  
 Seite / page 356

**Hakenleisten & Türgarderoben Metall**  
**hookrails & door warderobes metal**



**Art-Nr. 2452**  
 Seite / page 360



**Art-Nr. 2430**  
 Seite / page 360



**Art-Nr. 2399**  
 Seite / page 378



**Art-Nr. 2378**  
 Seite / page 378



**Art-Nr. 2323**  
 Seite / page 360



**Art-Nr. 2312**  
 Seite / page 360



**Art-Nr. 2305**  
 Seite / page 362

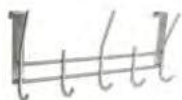

**Art-Nr. 2257**  
 Seite / page 378



**Art-Nr. 2256**  
 Seite / page 362

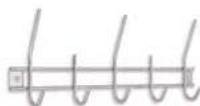

**Art-Nr. 2255**  
 Seite / page 362



**Art-Nr. 2226**  
 Seite / page 362



**Art-Nr. 2215**  
 Seite / page 362

## Artikelübersicht / overview items

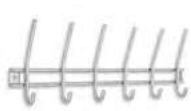

**Art-Nr. 2196**  
Seite / page 363



**Art-Nr. 2180**  
Seite / page 378



**Art-Nr. 2179**  
Seite / page 378



**Art-Nr. 2165**  
Seite / page 363



**Art-Nr. 2144**  
Seite / page 379



**Art-Nr. 2143**  
Seite / page 379



**Art-Nr. 2088**  
Seite / page 364



**Art-Nr. 2083**  
Seite / page 364



**Art-Nr. 2081DM**  
Seite / page 364



**Art-Nr. 2081**  
Seite / page 364



**Art-Nr. 2077**  
Seite / page 364



**Art-Nr. 1996**  
Seite / page 382



**Art-Nr. 1983**  
Seite / page 380



**Art-Nr. 1977**  
Seite / page 380



**Art-Nr. 1891**  
Seite / page 365



**Art-Nr. 1890**  
Seite / page 365



**Art-Nr. 1875**  
Seite / page 366



**Art-Nr. 1829**  
Seite / page 380



**Art-Nr. 1783**  
Seite / page 366



**Art-Nr. 1674**  
Seite / page 366



**Art-Nr. 1673**  
Seite / page 366



**Art-Nr. 1603**  
Seite / page 366



**Art-Nr. 1464**  
Seite / page 367



**Art-Nr. 1444**  
Seite / page 367



**Art-Nr. 1443**  
Seite / page 380



**Art-Nr. 1413**  
Seite / page 380



**Art-Nr. 1412**  
Seite / page 381



**Art-Nr. 1411**  
Seite / page 368



**Art-Nr. 1410**  
Seite / page 381



**Art-Nr. 1355**  
Seite / page 368



**Art-Nr. 1334**  
Seite / page 368

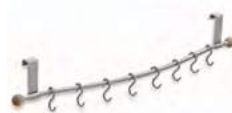

**Art-Nr. 1296**  
Seite / page 381



**Art-Nr. 1295**  
Seite / page 368



**Art-Nr. 1290**  
Seite / page 368



**Art-Nr. 1163**  
Seite / page 370



**Art-Nr. 1161**  
Seite / page 370



**Art-Nr. 1135**  
Seite / page 369



**Art-Nr. 1024**  
Seite / page 370



**Art-Nr. 749**  
Seite / page 370



**Art-Nr. 618**  
Seite / page 370

## Hakenleisten & Türgarderoben Kunststoff hookrails & door warderobes plastic



**Art-Nr. 01047**  
Seite / page 372



**Art-Nr. 01007**  
Seite / page 382



**Art-Nr. 0970**  
Seite / page 372



**Art-Nr. 0841**  
Seite / page 372



**Art-Nr. 0464**  
Seite / page 372



**Art-Nr. H206**  
Seite / page 382

## Artikelübersicht / overview items



**Art.-Nr. H205**  
Seite / page 372



**Art.-Nr. H190**  
Seite / page 374



**Art.-Nr. H184**  
Seite / page 374



**Art.-Nr. MI687**  
Seite / page 382



**Art.-Nr. SM8177**  
Seite / page 374



**Art.-Nr. SM8164**  
Seite / page 374



**Art.-Nr. SM8163**  
Seite / page 374



**Art.-Nr. SM8162**  
Seite / page 375



**Art.-Nr. SM8161**  
Seite / page 375

## Hakenleisten Holz hookrails wood



**Art.-Nr. S668**  
Seite / page 376



**Art.-Nr. S662**  
Seite / page 376



**Art.-Nr. S660**  
Seite / page 376



**Art.-Nr. S641**  
Seite / page 376



**Art.-Nr. S307**  
Seite / page 377



**Art.-Nr. S126**  
Seite / page 377



**Art.-Nr. S124**  
Seite / page 377



**Art.-Nr. S123**  
Seite / page 377

## Sonderartikel Metall special items metal



**Art.-Nr. 2459**  
Seite / page 386



**Art.-Nr. 2431**  
Seite / page 390



**Art.-Nr. 2429**  
Seite / page 386



**Art.-Nr. 2390**  
Seite / page 388



**Art.-Nr. 2361**  
Seite / page 390



**Art.-Nr. 2352**  
Seite / page 390



**Art.-Nr. 2300**  
Seite / page 393



**Art.-Nr. 2299**  
Seite / page 393



**Art.-Nr. 2233**  
Seite / page 396



**Art.-Nr. 2158**  
Seite / page 396



**Art.-Nr. 2142**  
Seite / page 393



**Art.-Nr. 2139**  
Seite / page 396



**Art.-Nr. 1449**  
Seite / page 400



**Art.-Nr. 1448**  
Seite / page 400



**Art.-Nr. 1447**  
Seite / page 400



**Art.-Nr. 1446**  
Seite / page 400



**Art.-Nr. 1409**  
Seite / page 400



**Art.-Nr. 552**  
Seite / page 398

## Artikelübersicht / overview items



**Art.-Nr. 482**  
Seite / page 398



**Art.-Nr. 401**  
Seite / page 398



**Art.-Nr. KS**  
Seite / page 402



**Art.-Nr. KS-45BREAK**  
Seite / page 402



**Art.-Nr. SS**  
Seite / page 403



**Art.-Nr. ST4**  
Seite / page 403



**Art.-Nr. Z22**  
Seite / page 402

## Sonderartikel Kunststoff special items plastic



**Art.-Nr. 01094**  
Seite / page 394



**Art.-Nr. 01086**  
Seite / page 392



**Art.-Nr. 01085**  
Seite / page 392



**Art.-Nr. 0803**  
Seite / page 401



**Art.-Nr. 0498**  
Seite / page 397



**Art.-Nr. 0320**  
Seite / page 395



**Art.-Nr. 086**  
Seite / page 402



**Art.-Nr. H240**  
Seite / page 395



**Art.-Nr. H216**  
Seite / page 396



**Art.-Nr. H215**  
Seite / page 394



**Art.-Nr. H213**  
Seite / page 395



**Art.-Nr. H209**  
Seite / page 411



**Art.-Nr. H207**  
Seite / page 396



**Art.-Nr. H163**  
Seite / page 411



**Art.-Nr. H111**  
Seite / page 342

---

# METALL

---

*Metall wird seit Anbeginn der Zivilisation auf vielfältige Art und Weise verarbeitet und eingesetzt. Die Anwendungsmöglichkeiten für diesen Werkstoff scheinen dabei nahezu unendlich und er erfreut sich ungebrochen an großer Beliebtheit. Aus gutem Grund: Metalle überzeugen durch ihre Haltbarkeit, die individuellen Gestaltungsmöglichkeiten und eine zeitlose Eleganz.*

*Diese Vielfalt und Beständigkeit spiegeln sich auch in unseren Beschlägen dieser Produktgruppe wider. Sie sind robust, strapazierfähig und langlebig und erfüllen so über Jahrzehnte hinweg auch die höchsten Qualitätsansprüche. Raffinierte Details und ausgefallene Formen erlauben eine individuelle Möbelgestaltung nach jedem Geschmack: im Vintage-Stil oder voll im Trend, klassisch und elegant oder extravagant und verspielt.*

*Ebenso wird im Bereich der Oberflächengestaltung und Farbvielfalt eine reiche Auswahl geboten, dank der sich unsere Beschläge perfekt in ein bestehendes Ambiente einfügen. Aber auch auf die Funktionalität wird beim Design höchster Wert gelegt. Die ergonomische Formgebung und die pflegeleichten Materialien vereinen Form und Funktion und machen unsere Metallbeschläge zum idealen Partner für stark beanspruchte Bereiche.*

---

# METAL

---

*Since the very dawn of civilisation, metal has been used and worked in manifold ways. This material offers almost unlimited possibilities for usage and it has never lost its popularity. And there are good reasons for this: metals are durable, can be used to create many different design and boast a timeless elegance.*

*This diversity and reliability is reflected in the fittings found in this product group. They are robust, durable and long-lasting, fulfilling the highest expectations over a period of decades. Clever details and unusual shapes mean that furniture can be individually designed to suit every taste, whether vintage or modern, classical and elegant, or extravagant and fun. Our many different finishes and colours mean that our fittings are a perfect match for any setting.*

*Of course, we also pay the utmost attention to functionality when designing our products. The ergonomic shapes and easy-to-clean materials unite form with function, making our metal fittings the ideal choice for frequently used areas.*





2454



Bestellnummer | Order no.  
 2454-122PB12  
 2454-122ZN1  
 2454-122ZN21  
 2454-122ZN78  
 2454-218PB12  
 2454-218ZN1  
 2454-218ZN21  
 2454-218ZN78

Druckguss / die cast

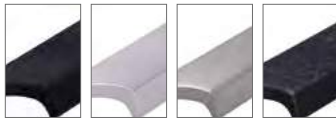

PB12 ZN1 ZN21 ZN78



L	B/W	H	LA/CC	VE/PU
218	22	20	160	10

2447



Bestellnummer | Order no.  
 2447-94PB12  
 2447-94PB32  
 2447-94ZN1  
 2447-94ZN21  
 2447-94ZN75  
 2447-94ZN83  
 2447-190PB12  
 2447-190PB32  
 2447-190ZN1  
 2447-190ZN16  
 2447-190ZN21  
 2447-190ZN75  
 2447-190ZN79  
 2447-190ZN83  
 2447-350PB12  
 2447-350PB32  
 2447-350ZN1  
 2447-350ZN21  
 2447-350ZN83

Druckguss / die cast



PB12 PB32 ZN1 ZN16 ZN21 ZN75 ZN79 ZN83



L	B/W	H	LA/CC	VE/PU
94	16	20	64	10
190	16	20	160	10
350	16	20	320	5

2356



Bestellnummer | Order no.  
 2356-185ZN1  
 2356-185ZN16  
 2356-185ZN21  
 2356-185ZN27  
 2356-185ZN68  
 2356-339ZN1  
 2356-339ZN16  
 2356-339ZN21  
 2356-339ZN27  
 2356-339ZN68

Druckguss / die cast

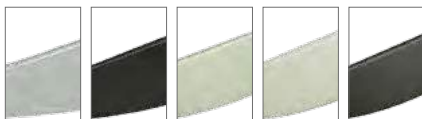

ZN1 ZN16 ZN21 ZN27 ZN68



L	B/W	H	LA/CC	VE/PU
184	18	23	160	10
339	18	24	320	5

LOCHABSTAND | CENTER TO CENTER

VERPACKUNGSEINHEIT | PACKING UNIT

DURCHMESSER | DIAMETER

LÄNGE | LENGTH

BREITE | WIDTH

HÖHE | HEIGHT



# HYBRIDGRIFFE

Griff oder Griffleiste – Warum nicht einfach beides?

Die Hybridgriffe von SIRO sind die perfekte Fusion von Griff und Griffleiste und ihr schlankes Design entspricht den neuesten Trends. Ob sie mittig wie ein Griff oder bündig an der Oberkante wie eine Leiste platziert werden, bleibt dabei dem persönlichen Geschmack überlassen.

# HYBRIDHANDLES

Handle or integrated handle - why choose?

SIRO's hybrid handles are the perfect combination of handle and integrated handle, their minimalist design reflecting the latest trends. Place them in the middle of a door like a classic handle, or flush mount to the upper edge-it's your choice!



2467



Aluminium / aluminium



AL72

PB12

Bestellnummer | Order no.

- 2467-245AL72
- 2467-245PB12
- 2467-295AL72
- 2467-295PB12
- 2467-345AL72
- 2467-345PB12
- 2467-395AL72
- 2467-395PB12
- 2467-445AL72
- 2467-445PB12
- 2467-495AL72
- 2467-495PB12
- 2467-545AL72
- 2467-545PB12
- 2467-595AL72
- 2467-595PB12
- 2467-695AL72
- 2467-695PB12
- 2467-795AL72
- 2467-795PB12
- 2467-895AL72
- 2467-895PB12
- 2467-995AL72
- 2467-995PB12
- 2467-1095AL72
- 2467-1095PB12
- 2467-1195AL72
- 2467-1195PB12



L	B/W	H	VE/PU	L	B/W	H	VE/PU
245	13	43	10	595	13	43	5
295	13	43	10	695	13	43	5
345	13	43	10	795	13	43	5
395	13	43	10	895	13	43	5
445	13	43	5	995	13	43	5
495	13	43	5	1095	13	43	5
545	13	43	5	1195	13	43	5

2466



Aluminium / aluminium

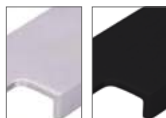

AL72

PB12

Bestellnummer | Order no.

- 2466-245AL72
- 2466-245PB12
- 2466-295AL72
- 2466-295PB12
- 2466-345AL72
- 2466-345PB12
- 2466-395AL72
- 2466-395PB12
- 2466-445AL72
- 2466-445PB12
- 2466-495AL72
- 2466-495PB12
- 2466-545AL72
- 2466-545PB12
- 2466-595AL72
- 2466-595PB12
- 2466-695AL72
- 2466-695PB12
- 2466-795AL72
- 2466-795PB12
- 2466-895AL72
- 2466-895PB12
- 2466-995AL72
- 2466-995PB12
- 2466-1095AL72
- 2466-1095PB12
- 2466-1195AL72
- 2466-1195PB12

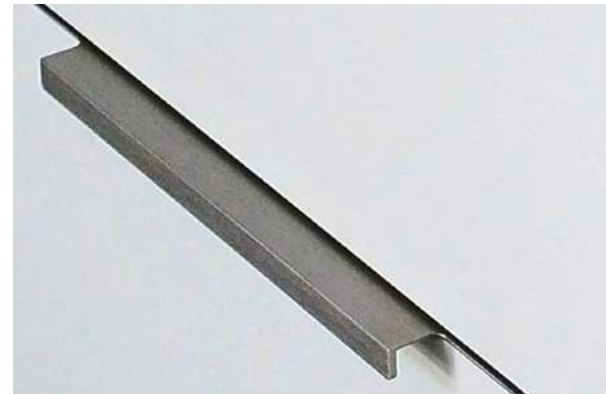

L	B/W	H	VE/PU	L	B/W	H	VE/PU
245	13	38	10	595	13	38	5
295	13	38	10	695	13	38	5
345	13	38	10	795	13	38	5
395	13	38	10	895	13	38	5
445	13	38	5	995	13	38	5
495	13	38	5	1095	13	38	5
545	13	38	5	1195	13	38	5

2446



Aluminium / aluminium



PB1

PB12

ZN1

ZN5

ZN21

ZN75

ZN79

Bestellnummer | Order no.

- 2446-70PB1
- 2446-70PB12
- 2446-70ZN1
- 2446-70ZN5
- 2446-70ZN21
- 2446-70ZN75
- 2446-70ZN79
- 2446-145PB1
- 2446-145PB12
- 2446-145ZN1
- 2446-145ZN21
- 2446-145ZN75
- 2446-145ZN79



L	B/W	H	LA/CC	VE/PU
70	20	40	48	10
145	20	40	128	10

↔ LOCHABSTAND | CENTER TO CENTER

📦 VERPACKUNGSEINHEIT | PACKING UNIT

⌀ DURCHMESSER | DIAMETER

↔ LÄNGE | LENGTH

📏 BREITE | WIDTH

📏 HÖHE | HEIGHT

2373





Bestellnummer | Order no.  
2373-32N1  
2373-96N1  
2373-192N1



Edelstahl / stainless steel



N1

 L	 B/W	 H	 LA/CC	 VE/PU
32	20	40	16	10
96	20	40	64	10
192	20	40	160	10



2372



Bestellnummer | Order no.  
2372-32N1  
2372-96N1  
2372-192N1

Edelstahl / stainless steel



N1

L	B/W	H	LA/CC	VE/PU
32	20	40	16	10
96	20	40	64	10
192	20	40	160	10



2311

zum Verkleben / Simply apply adhesive



Bestellnummer | Order no.  
2311-200PB12  
2311-200PB21  
2311-200ZN1  
2311-200ZN21  
2311-200ZN83  
2311-360PB12  
2311-360PB21  
2311-360ZN1  
2311-360ZN21

Druckguss / die cast

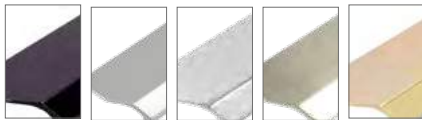

PB12

PB21

ZN1

ZN21

ZN83

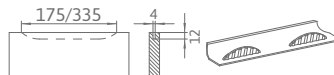

Montage auch mit Lamellendübelfräse  
möglich /  
mounting also possible with biscuit joiner

L	B/W	H	VE/PU
200	13	40	10
360	13	40	5



2005



Aluminium / aluminium

Bestellnummer | Order no.  
2005-45AL1  
2005-45PB1  
2005-45PB12  
2005-45ZN21



AL1

PB1

PB12

ZN21

L	B/W	H	LA/CC	VE/PU
45	20	50	32	10



⇔ LOCHABSTAND | CENTER TO CENTER

☐ VERPACKUNGSEINHEIT | PACKING UNIT

∅ DURCHMESSER | DIAMETER

⇔ LÄNGE | LENGTH

↗ BREITE | WIDTH

↑ HÖHE | HEIGHT

1621



Bestellnummer | Order no.  
1621-148AL1

Aluminium / aluminium

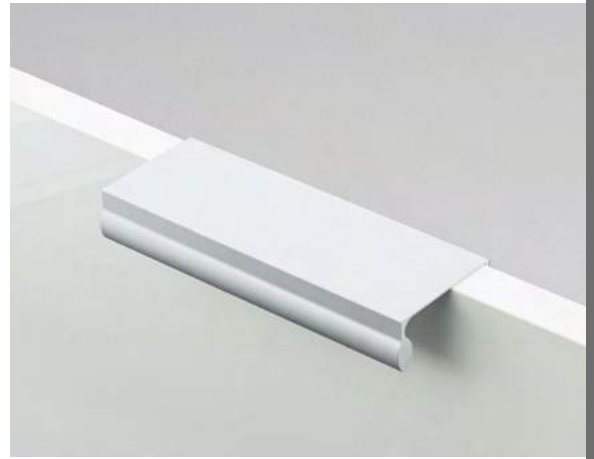

AL1

				
L 148	B/W 23	H 50	LA/CC 128	VE/PU 10



2464



Aluminium / aluminium

Passend zu 2462, 2463 Seite 290, 2459 Seite 386  
matching 2462, 2463 page 290, 2459 page 386

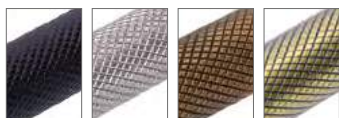

PB12 ZN27 ZN79 ZN83

Bestellnummer | Order no.

2464-16PB12  
2464-16ZN27  
2464-16ZN79  
2464-16ZN83  
2464-24PB12  
2464-24ZN27  
2464-24ZN79  
2464-24ZN83

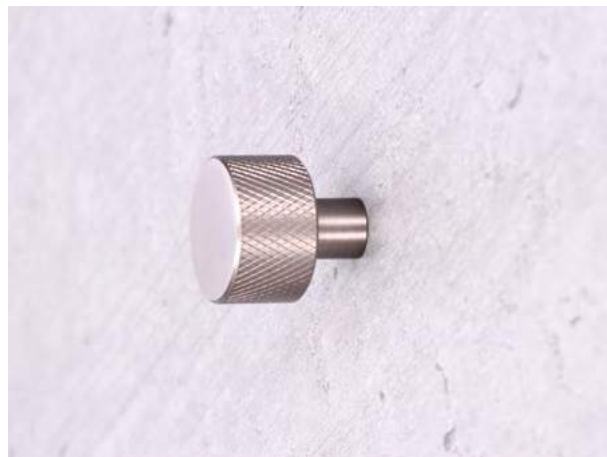

D	D/S	H	VE/PU
16	10	25	10
24	10	25	10

2457



Aluminium - Druckguss / aluminium - die cast

Passend zu 2462, 2463 Seite 290, 2459 Seite 386  
matching 2462, 2463 page 290, 2459 page 386

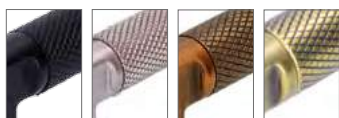

PB12PB12 ZN27ZN27 ZN79ZN79 ZN83ZN83

Bestellnummer | Order no.

2457-110PB12PB12  
2457-110ZN27ZN27  
2457-142PB12PB12  
2457-142ZN27ZN27  
2457-142ZN79ZN79  
2457-174PB12PB12  
2457-174ZN27ZN27  
2457-174ZN79ZN79  
2457-174ZN83ZN83  
2457-206PB12PB12  
2457-206ZN27ZN27  
2457-334PB12PB12  
2457-334ZN27ZN27  
2457-334ZN83ZN83



L	B/W	H	LA/CC	VE/PU
110	12	32	96	10
142	12	32	128	10
174	12	32	160	10
206	12	32	192	10
334	12	32	320	5

2458



Druckguss / die cast



PB12

Bestellnummer | Order no.

2458-146PB12



L	B/W	H	LA/CC	VE/PU
146	51	20	96	10

↔ LOCHABSTAND | CENTER TO CENTER

↔ LÄNGE | LENGTH

☐ VERPACKUNGSEINHEIT | PACKING UNIT

↔ BREITE | WIDTH

⊘ DURCHMESSER | DIAMETER

↑ HÖHE | HEIGHT

2448



Bestellnummer | Order no.  
 2448-196PB12  
 2448-196PB32C  
 2448-196ZN27  
 2448-356PB12  
 2448-356PB32C  
 2448-356ZN27



Druckguss / die cast



PB12 PB32C ZN27

L	B/W	H	LA/CC	VE/PU
195	10	27	160	10
355	10	27	320	5



Abbildung: 2457-334PB12PB12, 2457-142PB12PB12

2442



Bestellnummer | Order no.  
2442-171ZN16  
2442-171ZN21  
2442-171ZN75

Druckguss / die cast



ZN16 ZN21 ZN75



L 171 B/W 15 H 31 LA/CC 160 VE/PU 10



2441



Bestellnummer | Order no.  
2441-56ZN16  
2441-56ZN21  
2441-56ZN75

Druckguss / die cast

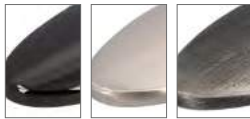

ZN16 ZN21 ZN75



L 56 B/W 20 H 28 LA/CC 16 VE/PU 10



2440



Bestellnummer | Order no.  
2440-170ZN1  
2440-170ZN28  
2440-170ZN78  
2440-170ZN79

Druckguss / die cast



ZN1 ZN28 ZN78 ZN79

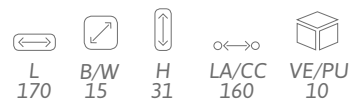

L 170 B/W 15 H 31 LA/CC 160 VE/PU 10



↔ LOCHABSTAND | CENTER TO CENTER

📦 VERPACKUNGSEINHEIT | PACKING UNIT

⌀ DURCHMESSER | DIAMETER

↔ LÄNGE | LENGTH

📏 BREITE | WIDTH

📏 HÖHE | HEIGHT



2439



Druckguss / die cast

Bestellnummer | Order no.  
2439-32ZN1  
2439-32ZN28  
2439-32ZN78  
2439-32ZN79

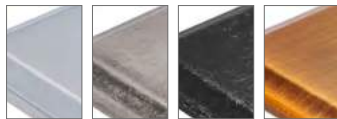

ZN1 ZN28 ZN78 ZN79



Abbildung: 2439-32ZN28 , 2440-170ZN28

2438



Druckguss / die cast

Bestellnummer | Order no.

- 2438-32PB12
- 2438-32ZN1
- 2438-32ZN16
- 2438-32ZN21
- 2438-32ZN75
- 2438-32ZN77
- 2438-32ZN79
- 2438-32ZN83

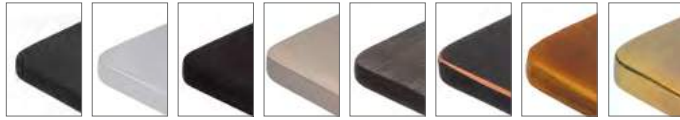

PB12 ZN1 ZN16 ZN21 ZN75 ZN77 ZN79 ZN83



2411



Druckguss / die cast

Bestellnummer | Order no.

- 2411-58PB12
- 2411-58ZN1
- 2411-58ZN16
- 2411-58ZN21
- 2411-58ZN77
- 2411-58ZN78
- 2411-58ZN79

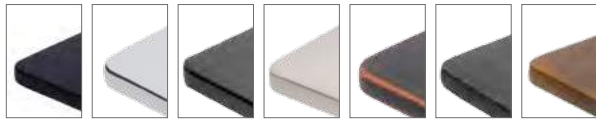

PB12 ZN1 ZN16 ZN21 ZN77 ZN78 ZN79

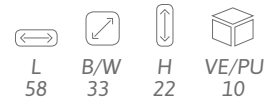

2416



Druckguss / die cast

Bestellnummer | Order no.

- 2416-16ZN1
- 2416-16ZN4



ZN1 ZN4

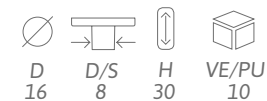

↔ LOCHABSTAND | CENTER TO CENTER

☐ VERPACKUNGSEINHEIT | PACKING UNIT

∅ DURCHMESSER | DIAMETER

↔ LÄNGE | LENGTH

↔ BREITE | WIDTH

↑ HÖHE | HEIGHT



Abbildung:  
2411-58ZN79

Abbildung: 2438-32ZN21

METALL metal

2415



Bestellnummer | Order no.  
 2415-192ZN1  
 2415-192ZN16  
 2415-192ZN21  
 2415-352ZN1  
 2415-352ZN16  
 2415-352ZN21

Druckguss / die cast



ZN1 ZN16 ZN21

L	B/W	H	LA/CC	VE/PU
192	12	33	160	10
352	12	33	320	5



2414



Bestellnummer | Order no.  
 2414-188ZN27  
 2414-188ZN68  
 2414-348ZN27  
 2414-348ZN68

Druckguss / die cast



ZN27 ZN68

L	B/W	H	LA/CC	VE/PU
188	17	29	160	10
348	17	31	320	5



2413



Bestellnummer | Order no.  
 2413-175ZN1  
 2413-175ZN16  
 2413-175ZN21  
 2413-335ZN1  
 2413-335ZN16  
 2413-335ZN21

Druckguss / die cast



ZN1 ZN16 ZN21

L	B/W	H	LA/CC	VE/PU
174	13	31	160	10
335	13	31	320	5



↔ LOCHABSTAND | CENTER TO CENTER

📦 VERPACKUNGSEINHEIT | PACKING UNIT

⌀ DURCHMESSER | DIAMETER

↔ LÄNGE | LENGTH

📏 BREITE | WIDTH

📏 HÖHE | HEIGHT

2415-352ZN1

2415-352ZN21

2415-352ZN16

2415-192ZN1

2415-192ZN21

2415-192ZN16

2414-348ZN68

2414-348ZN27

2414-188ZN68

2414-188ZN27

2413-335ZN1

2413-335ZN21

2413-335ZN16

2413-175ZN1

2413-175ZN21

2413-175ZN16

2412



Druckguss / die cast



ZN1 ZN21 ZN75

Bestellnummer | Order no.  
2412-62ZN1  
2412-62ZN21  
2412-62ZN75

L	B/W	H	LA/CC	VE/PU
62	10	22	32	10



2394



Druckguss / die cast



PB12 PB32 ZN1 ZN21 ZN75 ZN79

Bestellnummer | Order no.  
2394-54PB12  
2394-54PB32  
2394-54ZN1  
2394-54ZN21  
2394-54ZN75  
2394-54ZN79  
2394-118PB12  
2394-118PB32  
2394-118ZN1  
2394-118ZN21  
2394-118ZN75  
2394-118ZN79

L	B/W	H	LA/CC	VE/PU
54 118	10 10	24 24	32 96	10 10



2392



Druckguss / die cast



PB12 ZN1 ZN16 ZN21

Bestellnummer | Order no.  
2392-192PB12  
2392-192ZN1  
2392-192ZN16  
2392-192ZN21  
2392-352PB12  
2392-352ZN1  
2392-352ZN16  
2392-352ZN21

L	B/W	H	LA/CC	VE/PU
192 352	12 12	30 30	160 320	10 5



LOCHABSTAND | CENTER TO CENTER

VERPACKUNGSEINHEIT | PACKING UNIT

DURCHMESSER | DIAMETER

LÄNGE | LENGTH

BREITE | WIDTH

HÖHE | HEIGHT



Abbildung: 2394-118ZN1

Abbildung: 2392-352ZN1, 2392-192ZN1

2391



Bestellnummer | Order no.  
 2391-168ZN1  
 2391-168ZN16  
 2391-168ZN21  
 2391-328ZN1  
 2391-328ZN16  
 2391-328ZN21

Druckguss / die cast



ZN1 ZN16 ZN21



L	B/W	H	LA/CC	VE/PU
168	12	30	160	10
328	12	30	320	5

2389



Druckguss / die cast



ZN1 ZN68 ZN79

Bestellnummer | Order no.  
 2389-10ZN1  
 2389-10ZN68  
 2389-10ZN79



L	B/W	H	D/S	VE/PU
10	10	22	10	10

2388



Druckguss / die cast



ZN1 ZN68 ZN79

Bestellnummer | Order no.  
 2388-105ZN1  
 2388-105ZN68  
 2388-105ZN79



L	B/W	H	LA/CC	VE/PU
105	10	17	96	10

↔ LOCHABSTAND | CENTER TO CENTER

📦 VERPACKUNGSEINHEIT | PACKING UNIT

⌀ DURCHMESSER | DIAMETER

↔ LÄNGE | LENGTH

📏 BREITE | WIDTH

📏 HÖHE | HEIGHT





Abbildung: 2391-328ZN1

METALL metal

2384

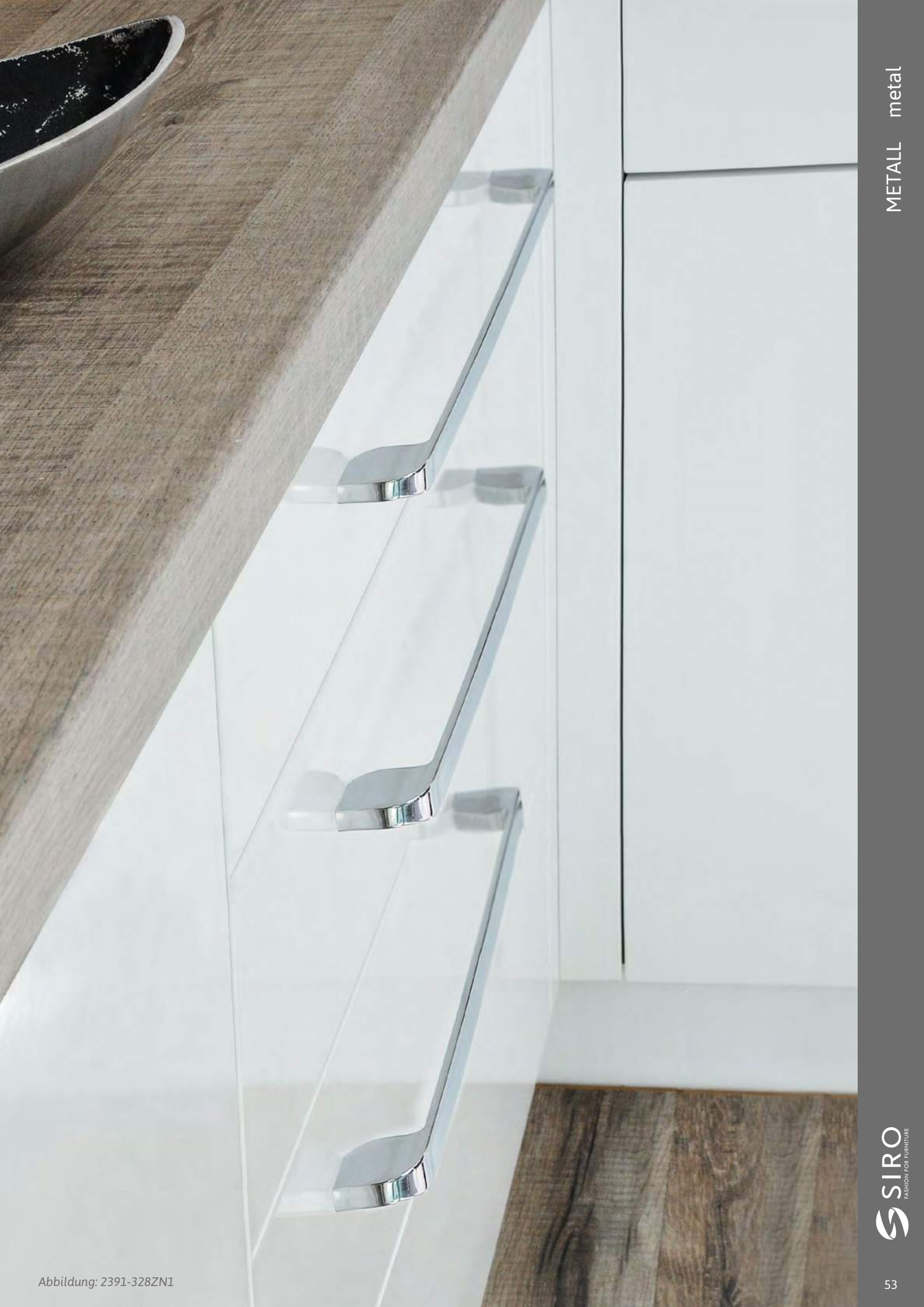

Aluminium / aluminium



AL1

Bestellnummer | Order no.  
2384-12AL1

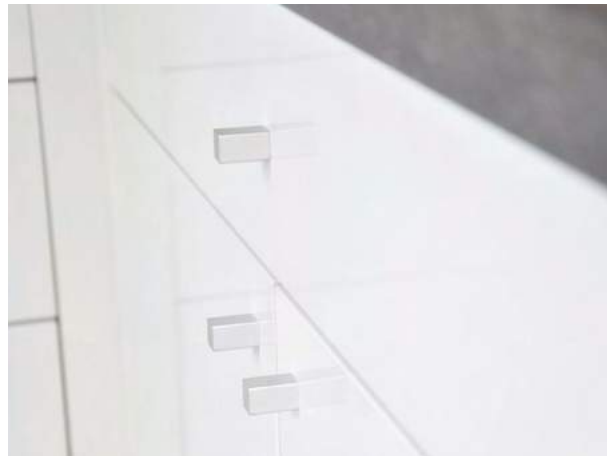

L	B/W	H	VE/PU
12	12	20	10

2382



Druckguss - Stahl / die cast - steel

Bestellnummer | Order no.  
2382-112PB1  
2382-112PB12  
2382-112ZN1ZN80  
2382-112ZN5ZN82  
2382-112ZN21ZN81  
2382-112ZN75  
2382-112ZN79

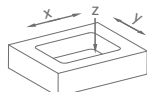

x	107
y	31
z	12,5

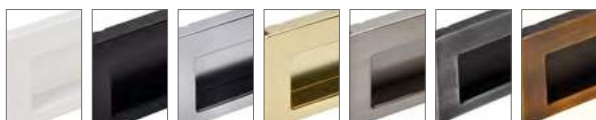

PB1 PB12 ZN1ZN80 ZN5ZN82 ZN21ZN81 ZN75 ZN79



L	B/W	H	LA/CC	VE/PU
112	38	13	96	10

2381



Druckguss / die cast

Bestellnummer | Order no.  
2381-188ZN1  
2381-188ZN16  
2381-188ZN21  
2381-188ZN68  
2381-348ZN1  
2381-348ZN16  
2381-348ZN21  
2381-348ZN68



ZN1 ZN16 ZN21 ZN68



L	B/W	H	LA/CC	VE/PU
188 348	16 16	30 31	160 320	10 5

↔ LOCHABSTAND | CENTER TO CENTER

↔ LÄNGE | LENGTH

VERPACKUNGSEINHEIT | PACKING UNIT

BREITE | WIDTH

DURCHMESSER | DIAMETER

HÖHE | HEIGHT



METALL metal

2374



Bestellnummer | Order no.

- 2374-180ZN1
- 2374-180ZN16
- 2374-180ZN21
- 2374-180ZN27
- 2374-180ZN75
- 2374-180ZN77
- 2374-180ZN78
- 2374-180ZN79
- 2374-340ZN1
- 2374-340ZN16
- 2374-340ZN21
- 2374-340ZN27
- 2374-340ZN75
- 2374-340ZN77
- 2374-340ZN79

Druckguss / die cast



ZN1 ZN16 ZN21 ZN27 ZN75 ZN77 ZN78 ZN79



L	B/W	H	LA/CC	VE/PU
180	25	29	160	10
340	25	29	320	5

2356



Bestellnummer | Order no.

- 2356-185ZN1
- 2356-185ZN16
- 2356-185ZN21
- 2356-185ZN27
- 2356-185ZN68
- 2356-339ZN1
- 2356-339ZN16
- 2356-339ZN21
- 2356-339ZN27
- 2356-339ZN68

Druckguss / die cast

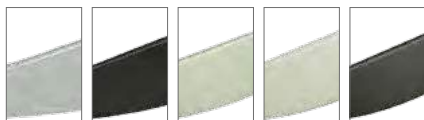

ZN1 ZN16 ZN21 ZN27 ZN68



L	B/W	H	LA/CC	VE/PU
184	18	23	160	10
339	18	24	320	5

2350F

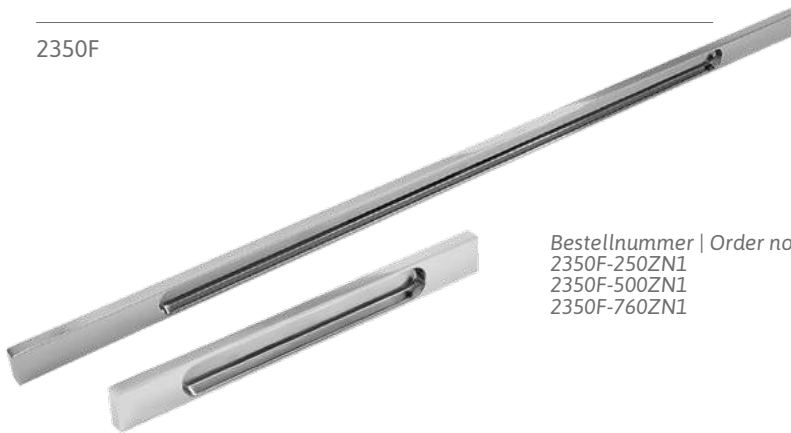

Bestellnummer | Order no.

- 2350F-250ZN1
- 2350F-500ZN1
- 2350F-760ZN1

Aluminium / aluminium



ZN1



L	B/W	H	LA/CC	VE/PU
250	10	25	192	5
500	10	25	448	5
760	10	25	704/576	5

LOCHABSTAND | CENTER TO CENTER

LÄNGE | LENGTH

VERPACKUNGSEINHEIT | PACKING UNIT

BREITE | WIDTH

DURCHMESSER | DIAMETER

HÖHE | HEIGHT



2374-180ZN79



2374-180ZN78



2374-180ZN77



2374-180ZN75

2343



Bestellnummer | Order no.  
 2343-183ZN1  
 2343-183ZN27  
 2343-183ZN78  
 2343-343ZN1  
 2343-343ZN27

Druckguss / die cast

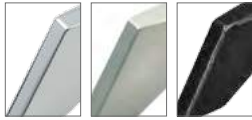

ZN1 ZN27 ZN78



L	B/W	H	LA/CC	VE/PU
183	15	27	160	10
343	15	27	320	5

2341



Bestellnummer | Order no.  
 2341-173ZN1  
 2341-173ZN16  
 2341-173ZN27  
 2341-345ZN1  
 2341-345ZN16  
 2341-345ZN27

Druckguss / die cast



ZN1 ZN16 ZN27



L	B/W	H	LA/CC	VE/PU
172	12	31	160	10
345	12	31	320	5

2340



Bestellnummer | Order no.  
 2340-173ZN1  
 2340-173ZN27  
 2340-173ZN68  
 2340-340ZN27  
 2340-340ZN68

Druckguss / die cast

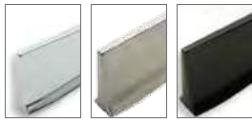

ZN1 ZN27 ZN68



L	B/W	H	LA/CC	VE/PU
173	12	30	160	10
340	12	30	320	5

↔ LOCHABSTAND | CENTER TO CENTER

☐ VERPACKUNGSEINHEIT | PACKING UNIT

∅ DURCHMESSER | DIAMETER

↔ LÄNGE | LENGTH

☐ BREITE | WIDTH

☐ HÖHE | HEIGHT

2343-343ZN1



2343-343ZN27

2343-183ZN1



2343-183ZN27



2343-183ZN78



2341-345ZN27



2341-345ZN16

2341-173ZN27



2341-345ZN1

2341-173ZN16



2341-173ZN1



2340-340ZN68



2340-340ZN27

2340-173ZN68



2340-173ZN27



2340-173ZN1



2338



Druckguss / die cast

Bestellnummer | Order no.  
 2338-64PB12  
 2338-64ZN1  
 2338-64ZN16  
 2338-64ZN27  
 2338-64ZN63  
 2338-64ZN66  
 2338-64ZN74  
 2338-64ZN78

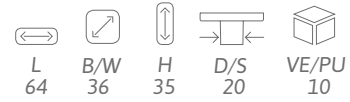
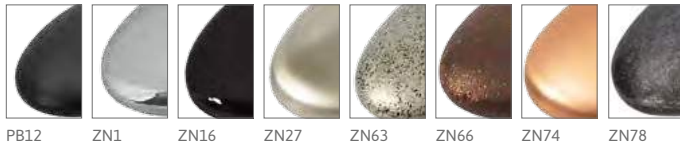

L 64  
 B/W 36  
 H 35  
 D/S 20  
 VE/PU 10



2328



Druckguss / die cast

Bestellnummer | Order no.  
 2328-205PB1  
 2328-205PB12  
 2328-205ZN1  
 2328-205ZN21  
 2328-205ZN78

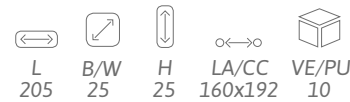

L 205  
 B/W 25  
 H 25  
 LA/CC 160x192  
 VE/PU 10



2318



Druckguss / die cast

Bestellnummer | Order no.  
 2318-200ZN1  
 2318-200ZN21  
 2318-200ZN74  
 2318-200ZN79  
 2318-360ZN1  
 2318-360ZN21  
 2318-360ZN74

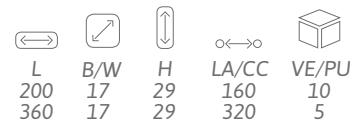
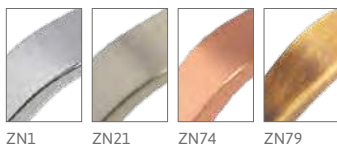

L 200  
 B/W 17  
 H 29  
 LA/CC 160  
 VE/PU 10  
 360 17 29 320 5



↔ LOCHABSTAND | CENTER TO CENTER

☐ VERPACKUNGSEINHEIT | PACKING UNIT

⌀ DURCHMESSER | DIAMETER

↔ LÄNGE | LENGTH

↗ BREITE | WIDTH

⌋ HÖHE | HEIGHT





Abbildung: 2338-64ZN27

2307



Bestellnummer | Order no.  
 2307-201ZN1  
 2307-201ZN16  
 2307-201ZN21  
 2307-360ZN1  
 2307-360ZN21

Druckguss / die cast

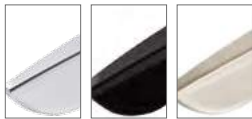

ZN1 ZN16 ZN21



L	B/W	H	LA/CC	VE/PU
201	19	29	160	10
360	20	32	320	5

2306



Bestellnummer | Order no.  
 2306-166ZN1  
 2306-166ZN21

Druckguss / die cast



ZN1 ZN21



L	B/W	H	LA/CC	VE/PU
166	36	27	64	10

2285



Bestellnummer | Order no.  
 2285-169ZN2  
 2285-169ZN4  
 2285-169ZN16  
 2285-169ZN21  
 2285-169ZN77

Druckguss / die cast

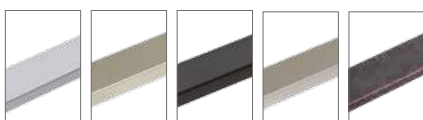

ZN2 ZN4 ZN16 ZN21 ZN77



L	B/W	H	LA/CC	VE/PU
169	20	29	160	10

↔ LOCHABSTAND | CENTER TO CENTER

↔ LÄNGE | LENGTH

📦 VERPACKUNGSEINHEIT | PACKING UNIT

📏 BREITE | WIDTH

⌀ DURCHMESSER | DIAMETER

📏 HÖHE | HEIGHT



Abbildung: 2285-169ZN4

2284

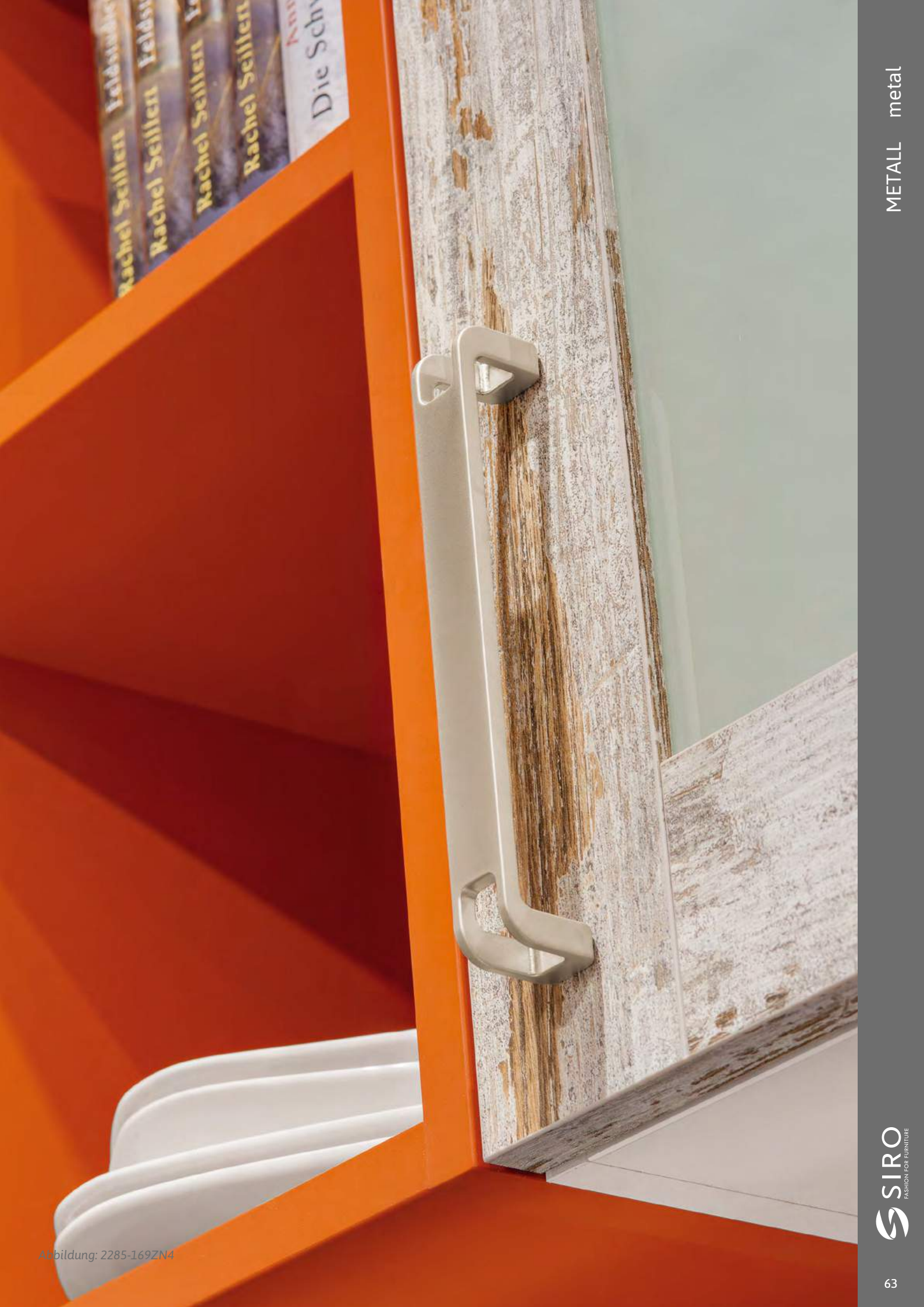

Bestellnummer | Order no.  
2284-72ZN1  
2284-72ZN4  
2284-72ZN21

Druckguss / die cast



ZN1 ZN4 ZN21

L	B/W	H	LA/CC	VE/PU
72	72	31	64	10



2267



Bestellnummer | Order no.  
2267-211ZN1  
2267-211ZN21  
2267-371ZN1  
2267-371ZN21

Druckguss / die cast

Passend zu Handtuchhalter 2299 Seite 393  
matching to towel rail 2299 page 393



ZN1 ZN21

L	B/W	H	LA/CC	VE/PU
210 370	10 10	33 33	160 320	10 5



2266



Bestellnummer | Order no.  
2266-145ZN1  
2266-145ZN21  
2266-177ZN1  
2266-177ZN16  
2266-177ZN21  
2266-177ZN68  
2266-209ZN1  
2266-209ZN21  
2266-337ZN1  
2266-337ZN16  
2266-337ZN21  
2266-337ZN68

Druckguss / die cast



ZN1 ZN16 ZN21 ZN68

L	B/W	H	LA/CC	VE/PU
145 177 209 337	15 15 15 15	30 30 30 30	128 160 192 320	10 10 10 5



LOCHABSTAND | CENTER TO CENTER

VERPACKUNGSEINHEIT | PACKING UNIT

DURCHMESSER | DIAMETER

LÄNGE | LENGTH

BREITE | WIDTH

HÖHE | HEIGHT



Abbildung: 2267-211ZN1, 2267-371ZN1

Abbildung: 2266-177ZN16

2262



Druckguss / die cast

Bestellnummer | Order no.  
2262-110ZN10



ZN10

L	B/W	H	LA/CC	VE/PU
110	18	21	96	10

2261



Druckguss / die cast

Bestellnummer | Order no.  
2261-138ZN21



ZN21

L	B/W	H	LA/CC	VE/PU
138	16	26	95	10

2238



Aluminium / aluminium

Bestellnummer | Order no.  
2238-252ZN1  
2238-252ZN21  
2238-284ZN1  
2238-284ZN21  
2238-316ZN1  
2238-316ZN21  
2238-348ZN1  
2238-348ZN21  
2238-604ZN21  
2238-764ZN1  
2238-764ZN21



ZN1

ZN21

L	B/W	H	LA/CC	VE/PU
252	11	32	128/224	10
284	11	32	160/256	10
316	11	32	192/288	10
348	11	32	224/320	10
604	11	32	480/576	5
764	11	32	640/736	5

2237



Aluminium / aluminium

Bestellnummer | Order no.  
2237-186ZN1  
2237-186ZN21  
2237-218ZN1  
2237-218ZN21  
2237-250ZN1  
2237-250ZN21  
2237-378ZN1  
2237-378ZN21  
2237-538ZN1  
2237-538ZN21  
2237-698ZN1



ZN1

ZN21

L	B/W	H	LA/CC	VE/PU
186	10	29	128	10
218	10	29	160	10
250	10	29	192	10
378	10	29	320	10
538	10	29	480	5
698	10	29	640	5

2231



Druckguss / die cast

Bestellnummer | Order no.  
2231-66ZN1  
2231-66ZN21



ZN1

ZN21

L	B/W	H	VE/PU
66	13	17	10

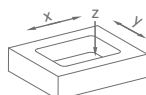

x 63  
y 10  
z 13

Passend zu 2227 Seite 296  
matching 2227 page 296

waagrecht und senkrecht verwendbar, durch Feder selbst schließend /  
for horizontal and vertical use, self-closing by spring

LOCHABSTAND | CENTER TO CENTER

VERPACKUNGSEINHEIT | PACKING UNIT

DURCHMESSER | DIAMETER

LÄNGE | LENGTH

BREITE | WIDTH

HÖHE | HEIGHT

2211



Bestellnummer | Order no.  
 2211-202ZN1  
 2211-266ZN1  
 2211-266ZN21

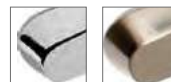

ZN1      ZN21

L	B/W	H	LA/CC	VE/PU
203 267	8 8	28 28	160 224	10 5

Druckguss / die cast

2210



Bestellnummer | Order no.  
 2210-150ZN1  
 2210-150ZN21  
 2210-270ZN1  
 2210-270ZN21



ZN1      ZN21

L	B/W	H	LA/CC	VE/PU
150 270	8 8	27 27	128 256	10 5

Druckguss / die cast



Abbildung: 2211-266ZN1

2209



Bestellnummer | Order no.  
2209-260ZN1  
2209-260ZN21

Druckguss / die cast



ZN1

ZN21

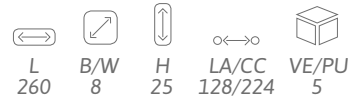

2208



Bestellnummer | Order no.  
2208-310ZN1  
2208-310ZN21

Druckguss / die cast



ZN1

ZN21

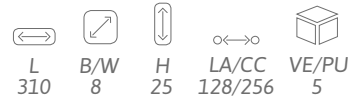

2206



Bestellnummer | Order no.  
2206-116ZN1  
2206-116ZN21

Druckguss / die cast



ZN1

ZN21

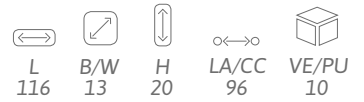

2205



Bestellnummer | Order no.  
2205-11ZN1  
2205-11ZN21

Druckguss / die cast



ZN1

ZN21

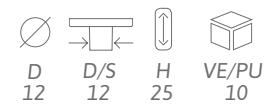

2204



Bestellnummer | Order no.  
2204-68ZN60

Druckguss / die cast



ZN60

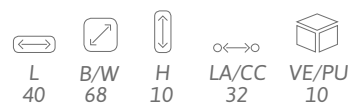



2200



Druckguss / die cast

Bestellnummer | Order no.  
2200-184ZN1  
2200-184ZN21

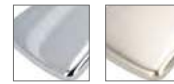

ZN1 ZN21

L	B/W	H	LA/CC	VE/PU
184	22	24	128	10

2199



Druckguss / die cast

Bestellnummer | Order no.  
2199-205ZN1  
2199-205ZN21  
2199-359ZN1  
2199-359ZN21

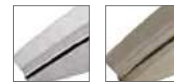

ZN1 ZN21

L	B/W	H	LA/CC	VE/PU
204 358	24 25	32 34	160 320	10 5



Abbildung: 2199-205ZN21

2198



Druckguss / die cast

Bestellnummer | Order no.  
 2198-173ZN1  
 2198-173ZN21  
 2198-173ZN63  
 2198-333ZN1  
 2198-333ZN21  
 2198-333ZN63



ZN1

ZN21

ZN63

L	B/W	H	LA/CC	VE/PU
173	12	31	160	10
332	12	31	320	5

2197



Druckguss / die cast

Bestellnummer | Order no.  
 2197-214ZN1  
 2197-214ZN21  
 2197-214ZN66  
 2197-214ZN75  
 2197-374ZN1  
 2197-374ZN21

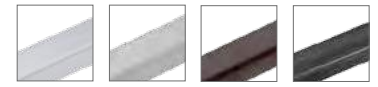

ZN1

ZN21

ZN66

ZN75

L	B/W	H	LA/CC	VE/PU
214	10	30	128	10
374	10	30	288	5

2184



Druckguss - Kunststoff / die cast - plastic

Bestellnummer | Order no.  
 2184-137ZN1GH1  
 2184-137ZN1GH2  
 2184-137ZN21GH1  
 2184-137ZN21GH2  
 2184-200ZN1GH1  
 2184-200ZN1GH2  
 2184-200ZN21GH1  
 2184-200ZN21GH2

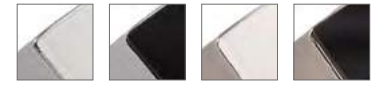

ZN1GH1

ZN1GH2

ZN21GH1

ZN21GH2

L	B/W	H	LA/CC	VE/PU
137	30	26	96	10
200	30	26	160	10

2183



Druckguss / die cast

Bestellnummer | Order no.  
 2183-104ZN1  
 2183-104ZN21  
 2183-168ZN1  
 2183-168ZN21  
 2183-328ZN1  
 2183-328ZN21



ZN1

ZN21

L	B/W	H	LA/CC	VE/PU
104	10	36	96	10
168	10	36	160	10
328	10	36	320	5

2182



Druckguss / die cast

Bestellnummer | Order no.  
 2182-118ZN1  
 2182-118ZN21  
 2182-118ZN63  
 2182-182ZN1  
 2182-182ZN16  
 2182-182ZN21  
 2182-182ZN63  
 2182-342ZN1  
 2182-342ZN21



ZN1

ZN16

ZN21

ZN63

L	B/W	H	LA/CC	VE/PU
118	8	33	96	10
182	8	33	160	10
342	8	33	320	5

⇔ LOCHABSTAND | CENTER TO CENTER

⇔ LÄNGE | LENGTH

☐ VERPACKUNGSEINHEIT | PACKING UNIT

↔ BREITE | WIDTH

∅ DURCHMESSER | DIAMETER

↑ HÖHE | HEIGHT

2170



Druckguss - Kunststoff / die cast - plastic

Bestellnummer | Order no.

2170-168ZN1A3

2170-168ZN1A4

2170-168ZN21A3

2170-168ZN21A4



ZN1A3



ZN1A4



ZN21A3



ZN21A4



L  
168



B/W  
10



H  
28



LA/CC  
128/160



VE/PU  
10



2163



Druckguss / die cast

Passend zu 2213, 2214 Seite 301  
matching 2213, 2214 page 301

Bestellnummer | Order no.  
2163-37ZN29  
2163-37ZN58



ZN29

ZN58

L	B/W	H	VE/PU
37	22	23	10

2162



Druckguss / die cast

Passend zu 2213, 2214 Seite 301  
matching 2213, 2214 page 301

Bestellnummer | Order no.  
2162-150ZN29  
2162-150ZN58

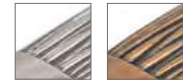

ZN29

ZN58

L	B/W	H	LA/CC	VE/PU
149	22	27	96	10

2150

In Polen nicht lieferbar / Not available in Poland



Druckguss / die cast

Passend zu 2213, 2214 Seite 301  
matching 2213, 2214 page 301

Bestellnummer | Order no.  
2150-32ZN29



ZN29

L	B/W	H	VE/PU
32	32	26	10

2160



Aluminium - Kunststoff / aluminium - plastic

2161



Stahl - Druckguss / steel - die cast

Bestellnummer | Order no.  
2160-194AL1A109



AL1A109

L	B/W	H	LA/CC	VE/PU
195	15	36	160	10



PB12ZN1

PB12ZN21

ZN21ZN1

Bestellnummer | Order no.  
2161-108PB12ZN1  
2161-108PB12ZN21  
2161-140PB12ZN1  
2161-140PB12ZN21  
2161-172ZN21ZN1  
2161-332ZN21ZN1

L	B/W	H	LA/CC	VE/PU
108	16	37	96	10
140	16	37	128	10
172	16	37	160	10
332	16	37	320	5

2157



Druckguss / die cast

Bestellnummer | Order no.  
 2157-161ZN1  
 2157-161ZN2  
 2157-161ZN21  
 2157-161ZN63  
 2157-161ZN75  
 2157-161ZN78  
 2157-161ZN83

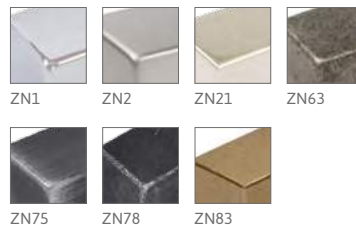

L 162	B/W 20	H 27	LA/CC 128	VE/PU 10

2156



Aluminium - Kunststoff / aluminium - plastic

Bestellnummer | Order no.  
 2156-172AL1G1



AL1G1

L 172	B/W 21	H 30	LA/CC 160	VE/PU 10

2136



Druckguss / die cast

Bestellnummer | Order no.  
 2136-184ZN1  
 2136-184ZN21  
 2136-312ZN1  
 2136-312ZN21



ZN1

ZN21

L 184 312	B/W 29 29	H 29 29	LA/CC 160 288	VE/PU 10 10



Abbildung: 2157-161ZN78

2159



Druckguss - Stahl / die cast - steel

Passend zu 2291, 2292, 2293, 2294 Seite 188  
matching 2291, 2292, 2293, 2294 page 188

Bestellnummer | Order no.

- 01 2159-40PB12
- 2159-40ZN1
- 02 2159-40ZN21
- 2159-50ZN1
- 03 2159-50ZN21
- 2159-70ZN1
- 2159-70ZN21

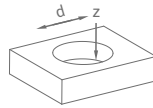

	01	02	03
d	35	40	60
z	14	14	14



PB12 ZN1 ZN21

	D	H	VE/PU
01	40	16	10
02	50	16	10
03	70	16	10

2155



Druckguss - Stahl / die cast - steel

Passend zu 2291, 2292, 2293, 2294 Seite 188  
matching 2291, 2292, 2293, 2294 page 188

Bestellnummer | Order no.

- 2155-125PB21
- 2155-125ZN1
- 2155-125ZN21

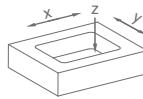

x	121
y	39
z	14



PB21 ZN1 ZN21

	L	B/W	H	VE/PU
01	125	45	16	10

2152



Druckguss - Stahl / die cast - steel

Passend zu 2291, 2292, 2293, 2294 Seite 188  
matching 2291, 2292, 2293, 2294 page 188

Bestellnummer | Order no.

- 01 2152-46PB21
- 2152-46ZN1
- 2152-46ZN21
- 02 2152-56ZN1
- 2152-56ZN21
- 03 2152-76PB21
- 2152-76ZN1
- 2152-76ZN21

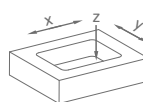

	01	02	03
x	40	50	70
y	40	50	70
z	11	14	14



PB21 ZN1 ZN21

	L	B/W	H	VE/PU
01	46	46	13	10
02	56	56	16	10
03	76	76	16	10

2151



Druckguss - Stahl / die cast - steel

Passend zu 2291, 2292, 2293, 2294 Seite 188  
matching 2291, 2292, 2293, 2294 page 188

Bestellnummer | Order no.

- 2151-90PB21
- 2151-90ZN1
- 2151-90ZN21

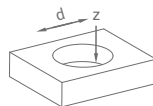

d	70
z	14



PB21 ZN1 ZN21

	D	H	VE/PU
01	90	16	10

2042



Druckguss - Stahl / die cast - steel

Passend zu 2291, 2292, 2293, 2294 Seite 188  
matching 2291, 2292, 2293, 2294 page 188

Bestellnummer | Order no.

- 2042-197PB21
- 2042-197ZN1
- 2042-197ZN21

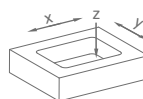

x	175
y	49
z	15



PB21 ZN1 ZN21

	L	B/W	H	LA/CC	VE/PU
01	197	54	20	160	10

↔ LOCHABSTAND | CENTER TO CENTER

↔ LÄNGE | LENGTH

☐ VERPACKUNGSEINHEIT | PACKING UNIT

↔ BREITE | WIDTH

⊘ DURCHMESSER | DIAMETER

↑ HÖHE | HEIGHT

1870



Stahl / steel

Passend zu 2291, 2292, 2293, 2294 Seite 188  
matching 2291, 2292, 2293, 2294 page 188

Bestellnummer | Order no.  
1870-26PB21ZN3  
1870-76PB21ZN3



PB21ZN3

L	B/W	H	VE/PU
26	26	6	10
76	25	8	10

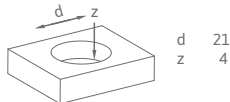
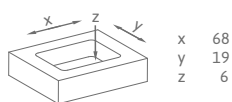

2129



Druckguss / die cast

Bestellnummer | Order no.  
2129-112ZN10



ZN10

L	B/W	H	LA/CC	VE/PU
111	11	23	96	10

2127



Druckguss / die cast

Bestellnummer | Order no.  
2127-65ZN29



ZN29

L	B/W	H	VE/PU
1 65	35	16	10
2 43	65	16	10

2120

In Italien nicht lieferbar / Not available in Italy



Druckguss / die cast

Bestellnummer | Order no.  
2120-136ZN1



ZN1

L	B/W	H	LA/CC	VE/PU
136	54	23	128	10



2118 *In Italien nicht lieferbar / Not available in Italy*



Druckguss / die cast

Bestellnummer | Order no.  
2118-60ZN1  
2118-60ZN21



L	B/W	H	LA/CC	VE/PU
60	59	24	32	10

2116



Druckguss / die cast

Bestellnummer | Order no.  
2116-38PB21  
2116-38ZN1  
2116-38ZN21



L	B/W	H	LA/CC	VE/PU
38	38	22	32	10

2113 *In Italien nicht lieferbar / Not available in Italy*



Druckguss / die cast

Bestellnummer | Order no.  
2113-137ZN1  
2113-137ZN21  
2113-168ZN1  
2113-168ZN21  
2113-200ZN1  
2113-200ZN21  
2113-232ZN1  
2113-232ZN21  
2113-265ZN1  
2113-265ZN21



L	B/W	H	LA/CC	VE/PU
137	30	20	96	10
169	30	22	128	10
201	30	24	160	10
233	30	24	192	10
265	30	26	224	10

2112 *In Italien nicht lieferbar / Not available in Italy*



Druckguss / die cast

Bestellnummer | Order no.  
2112-64ZN1  
2112-64ZN27  
2112-128ZN1  
2112-128ZN27  
2112-160ZN1  
2112-160ZN27



L	B/W	H	LA/CC	VE/PU
64	66	25	32	10
128	66	25	64/96	10
160	66	25	96/128	10

2064 *In Italien nicht lieferbar / Not available in Italy*



Druckguss / die cast

Bestellnummer | Order no.  
2064-140PB21  
2064-140ZN1  
2064-140ZN21



L	B/W	H	LA/CC	VE/PU
140	76	24	32/64/96	10



2063 *In Italien nicht lieferbar / Not available in Italy*



Druckguss / die cast

Bestellnummer | Order no.  
2063-80PB21  
2063-80ZN1  
2063-80ZN21



L 80	B/W 80	H 18	LA/CC 32	VE/PU 10

2057 *In Italien nicht lieferbar / Not available in Italy*



Druckguss / die cast

Bestellnummer | Order no.  
2057-75PB21  
2057-75ZN1  
2057-75ZN21



L 76	B/W 76	H 24	LA/CC 32	VE/PU 10

2053 *In Italien nicht lieferbar / Not available in Italy*



Druckguss / die cast

Bestellnummer | Order no.  
2053-80PB21  
2053-80ZN1  
2053-80ZN21  
2053-80ZN78

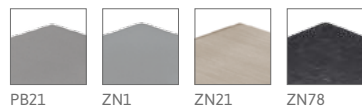

L 80	B/W 80	H 25	LA/CC 32	VE/PU 10



Abbildung: 2053-80ZN78

2110



Aluminium / aluminium

Passend zu Handtuchhalter 2142 Seite 393  
matching towel rail 2142 page 393

Bestellnummer | Order no.

- 2110-252AL1
- 2110-252ZN1
- 2110-252ZN21
- 2110-284AL1
- 2110-284ZN1
- 2110-284ZN21
- 2110-316AL1
- 2110-316ZN1
- 2110-316ZN21
- 2110-348AL1
- 2110-348ZN1
- 2110-348ZN21
- 2110-412AL1
- 2110-412ZN1
- 2110-412ZN21
- 2110-444AL1
- 2110-444ZN1
- 2110-444ZN21
- 2110-476AL1
- 2110-476ZN1
- 2110-476ZN21
- 2110-508AL1
- 2110-508ZN1
- 2110-508ZN21
- 2110-604AL1
- 2110-604ZN1
- 2110-604ZN21
- 2110-764AL1
- 2110-764ZN1
- 2110-764ZN21



AL1

ZN1

ZN21

L	B/W	H	LA/CC	VE/PU
252	10	29	128/224	5
284	10	29	160/256	5
316	10	29	192/288	5
348	10	29	224/320	5
412	10	29	288/384	5
444	10	29	320/416	5
476	10	29	352/448	5
508	10	29	384/480	5
604	10	29	480/576	5
764	10	29	640/736	5

2108



Druckguss / die cast

Bestellnummer | Order no.

- 2108-104PB1
- 2108-104PB12
- 2108-104PB21
- 2108-104ZN1
- 2108-104ZN5
- 2108-104ZN21
- 2108-104ZN75
- 2108-104ZN79
- 2108-136PB1
- 2108-136PB12
- 2108-136PB21
- 2108-136ZN1
- 2108-136ZN21
- 2108-136ZN75
- 2108-136ZN78
- 2108-136ZN79
- 2108-136ZN83
- 2108-168PB1
- 2108-168PB12
- 2108-168PB21
- 2108-168PB32C
- 2108-168ZN1
- 2108-168ZN5
- 2108-168ZN21
- 2108-168ZN74
- 2108-168ZN75
- 2108-168ZN78
- 2108-168ZN79
- 2108-168ZN83
- 2108-200PB1
- 2108-200PB12
- 2108-200PB21
- 2108-200ZN1
- 2108-200ZN5
- 2108-200ZN21
- 2108-200ZN75
- 2108-200ZN79
- 2108-232PB12
- 2108-232PB21
- 2108-232PB32C
- 2108-232ZN1
- 2108-232ZN21
- 2108-232ZN74
- 2108-232ZN83
- 2108-328PB21
- 2108-328ZN1
- 2108-328ZN21
- 2108-328ZN78

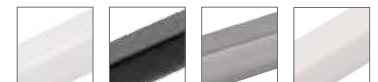

PB1

PB12

PB21

PB32C

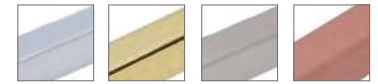

ZN1

ZN5

ZN21

ZN74

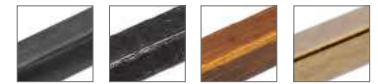

ZN75

ZN78

ZN79

ZN83

L	B/W	H	LA/CC	VE/PU
104	8	28	96	10
136	8	28	128	10
168	8	28	160	10
200	8	28	192	10
232	8	28	224	10
328	8	28	320	10

2105



Druckguss - Kunststoff / die cast - plastic

Bestellnummer | Order no.

- 2105-150ZN1SD1
- 2105-150ZN21SD3



ZN1SD1

ZN21SD3

L	B/W	H	LA/CC	VE/PU
149	22	26	128	10

2104



Bestellnummer | Order no.  
2104-34ZN1SD1  
2104-34ZN21SD3



ZN1SD1 ZN21SD3

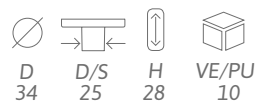

Druckguss - Kunststoff / die cast - plastic

2100



Bestellnummer | Order no.  
2100-39PB21A3  
2100-39PB21A4  
2100-39ZN1A3  
2100-39ZN1A4  
2100-39ZN21A3  
2100-39ZN21A4



PB21A3 PB21A4 ZN1A3 ZN1A4



ZN21A3 ZN21A4



Druckguss - Kunststoff / die cast - plastic

2090



Bestellnummer | Order no.  
2090-228ZN1A4



ZN1A4



Druckguss - Kunststoff / die cast - plastic

2089



Bestellnummer | Order no.  
2089-159ZN1A3



ZN1A3



Druckguss - Kunststoff / die cast - plastic



Abbildung: 2108-328ZN78, 2108-168ZN78, 2108-136ZN78

2096

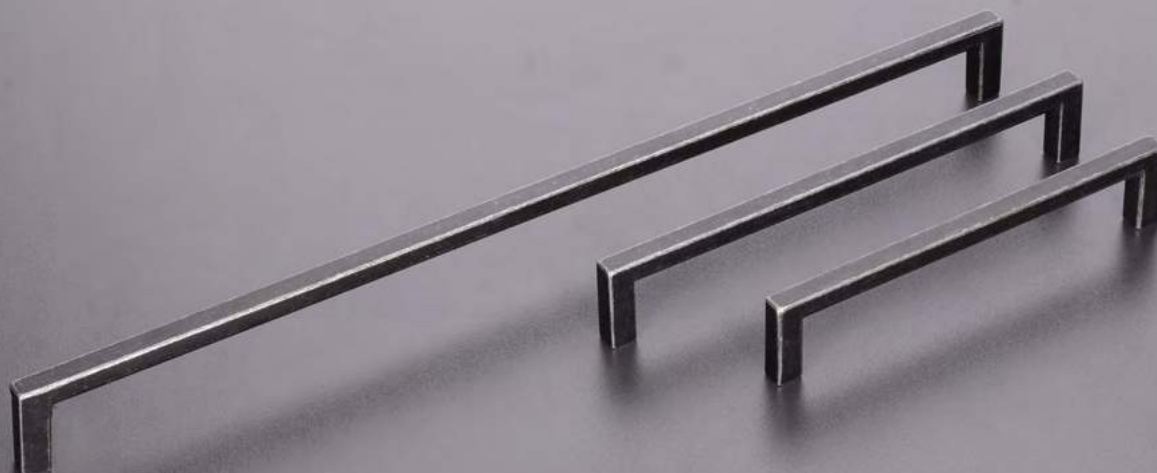

Bestellnummer | Order no.  
 2096-157PB21  
 2096-157ZN1  
 2096-157ZN21

Druckguss / die cast



				
L	B/W	H	LA/CC	VE/PU
157	29	21	128	10





2095



Bestellnummer | Order no.  
 2095-174PB21  
 2095-174ZN1  
 2095-174ZN21

Druckguss / die cast



				
L	B/W	H	LA/CC	VE/PU
174	20	22	128	10





2094



Bestellnummer | Order no.  
 2094-40PB21  
 2094-40ZN1  
 2094-40ZN21

Druckguss / die cast



				
L	B/W	H	LA/CC	VE/PU
39	39	23	32	10

2093





Linksausführung / left finish



Bestellnummer | Order no.  
 2093-65PB21  
 2093-65ZN1  
 2093-65ZN21

Druckguss / die cast



				
L	B/W	H	LA/CC	VE/PU
65	31	23	32	10

2092





Rechtsausführung / right finish



Bestellnummer | Order no.  
 2092-65PB21  
 2092-65ZN1  
 2092-65ZN21

Druckguss / die cast



				
L	B/W	H	LA/CC	VE/PU
65	31	23	32	10

2091



Druckguss / die cast

Bestellnummer | Order no.  
2091-179PB21  
2091-179ZN1  
2091-179ZN21



L	B/W	H	LA/CC	VE/PU
179	29	24	32	10

2087F



Druckguss / die cast

Bestellnummer | Order no.  
2087F-30PB12  
2087F-30ZN1  
2087F-30ZN21  
2087F-30ZN77  
2087F-30ZN78  
2087F-30ZN79  
2087F-30ZN83

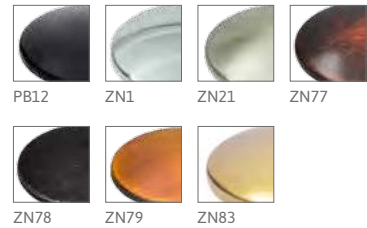

D	D/S	H	VE/PU
30	10	22	10



Abbildung: 2087F-30ZN1

2086



Aluminium / aluminium

Bestellnummer | Order no.  
2086-84AL1  
2086-148AL1



AL1

L	B/W	H	LA/CC	VE/PU
84 148	9 9	20 20	64 128	10 10

2084



Druckguss / die cast

Bestellnummer | Order no.  
2084-181ZN1  
2084-181ZN16  
2084-181ZN21  
2084-181ZN75  
2084-181ZN83



ZN1

ZN16

ZN21

ZN75



ZN83

L	B/W	H	LA/CC	VE/PU
180	15	25	160	10

2082



Druckguss / die cast

Bestellnummer | Order no.  
2082-160PB21  
2082-160ZN1  
2082-160ZN21



PB21

ZN1

ZN21

L	B/W	H	LA/CC	VE/PU
159	19	29	128	10

2039



Druckguss / die cast

Bestellnummer | Order no.  
2039-38PB12  
2039-38ZN10  
2039-38ZN21  
2039-38ZN28



PB12

ZN10

ZN21

ZN28

L	B/W	H	D/S	VE/PU
38	16	30	13	10

2076



Druckguss / die cast

Bestellnummer | Order no.  
2076-24ZN1  
2076-24ZN10  
2076-24ZN53



ZN1

ZN10

ZN53

L	B/W	H	D/S	VE/PU
24	24	21	9	10

2075



Druckguss / die cast

Bestellnummer | Order no.  
 2075-93ZN1  
 2075-93ZN10  
 2075-93ZN53



L 93	B/W 24	H 21	LA/CC 64	VE/PU 10

2074



Druckguss / die cast

Bestellnummer | Order no.  
 2074-33ZN1  
 2074-33ZN10  
 2074-33ZN53



L 33	B/W 24	H 21	D/S 9	VE/PU 10

2073



Druckguss / die cast

Bestellnummer | Order no.  
 2073-90ZN1  
 2073-90ZN10  
 2073-90ZN53



L 90	B/W 38	H 21	LA/CC 64	VE/PU 10



2035



Druckguss / die cast

Bestellnummer | Order no.  
 2035-72ZN1  
 2035-232ZN1  
 2035-232ZN21



ZN1

ZN21

L	B/W	H	LA/CC	VE/PU
72	35	40	64	10
232	35	40	224	10

2033



Druckguss / die cast

Bestellnummer | Order no.  
 2033-165ZN29  
 2033-165ZN31

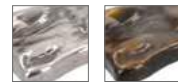

ZN29

ZN31

L	B/W	H	LA/CC	VE/PU
165	26	25	64	10

Passend zu 2019, 2020 Seite 304  
 matching 2019, 2020 page 304

2032



Druckguss / die cast

Bestellnummer | Order no.  
 2032-36ZN29  
 2032-36ZN31



ZN29

ZN31

L	B/W	H	VE/PU	
36	36	25	10	

Passend zu 2019, 2020 Seite 304  
 matching 2019, 2020 page 304

2016



Druckguss / die cast

Bestellnummer | Order no.  
 2016-94ZN29  
 2016-94ZN31



ZN29

ZN31

L	B/W	H	LA/CC	VE/PU
94	63	25	32	10

Passend zu 2019, 2020 Seite 304  
 matching 2019, 2020 page 304

2006



Druckguss / die cast

Bestellnummer | Order no.  
 2006-91ZN10  
 2006-91ZN29  
 2006-91ZN57



ZN10

ZN29

ZN57

L	B/W	H	LA/CC	VE/PU
91	68	27	32	10

LOCHABSTAND | CENTER TO CENTER

LÄNGE | LENGTH

VERPACKUNGSEINHEIT | PACKING UNIT

BREITE | WIDTH

DURCHMESSER | DIAMETER

HÖHE | HEIGHT



2028



Druckguss - Kunststoff / die cast - plastic

Bestellnummer | Order no.  
2028-41ZN28JE4  
2028-41ZN31JE4



ZN28JE4 ZN31JE4

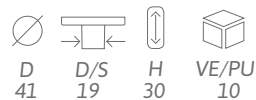

2015



Druckguss - Kunststoff / die cast - plastic

Bestellnummer | Order no.  
2015-54ZN28JE4  
2015-54ZN31JE4  
2015-67ZN28JE4  
2015-67ZN31JE4



ZN28JE4 ZN31JE4

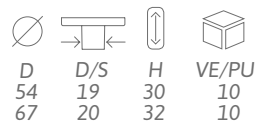

2029

In Polen nicht lieferbar / Not available in poland



Druckguss / die cast

Bestellnummer | Order no.  
2029-19ZN10



ZN10

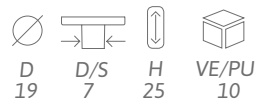

2027



Druckguss / die cast

- Bestellnummer | Order no.  
 2027-108ZN1  
 2027-108ZN2  
 2027-108ZN21  
 2027-140PB1  
 2027-140PB12  
 2027-140ZN1  
 2027-140ZN2  
 2027-140ZN21  
 2027-140ZN63  
 2027-172PB1  
 2027-172PB12  
 2027-172ZN1  
 2027-172ZN2  
 2027-172ZN21  
 2027-172ZN63  
 2027-172ZN75  
 2027-172ZN77  
 2027-172ZN78  
 2027-204PB1  
 2027-204PB12  
 2027-204ZN1  
 2027-204ZN2  
 2027-204ZN21  
 2027-204ZN63  
 2027-204ZN75  
 2027-332ZN1  
 2027-332ZN2  
 2027-332ZN21



L	B/W	H	LA/CC	VE/PU
108	9	30	96	10
140	9	30	128	10
172	9	30	160	10
204	9	30	192	10
332	9	30	320	5

2026



Druckguss / die cast

- Bestellnummer | Order no.  
 2026-40ZN1  
 2026-40ZN10  
 2026-138ZN1  
 2026-138ZN10  
 2026-202ZN1  
 2026-202ZN10



L	B/W	H	LA/CC	VE/PU
40	36	21	16	10
137	36	21	128	10
202	36	21	192	10

2025



Druckguss / die cast

- Bestellnummer | Order no.  
 2025-56ZN1  
 2025-56ZN29  
 2025-56ZN31



L	B/W	H	LA/CC	VE/PU
54	54	23	32	10

2024



Druckguss / die cast

- Bestellnummer | Order no.  
 2024-130ZN1  
 2024-130ZN29  
 2024-130ZN31



L	B/W	H	LA/CC	VE/PU
130	58	23	32	10

2023



Druckguss / die cast

Bestellnummer | Order no.  
2023-55ZN1  
2023-55ZN29  
2023-55ZN31



ZN1

ZN29

ZN31



L  
55

B/W  
27

H  
22

LA/CC  
16

VE/PU  
10



Abbildung: 2027-204ZN75

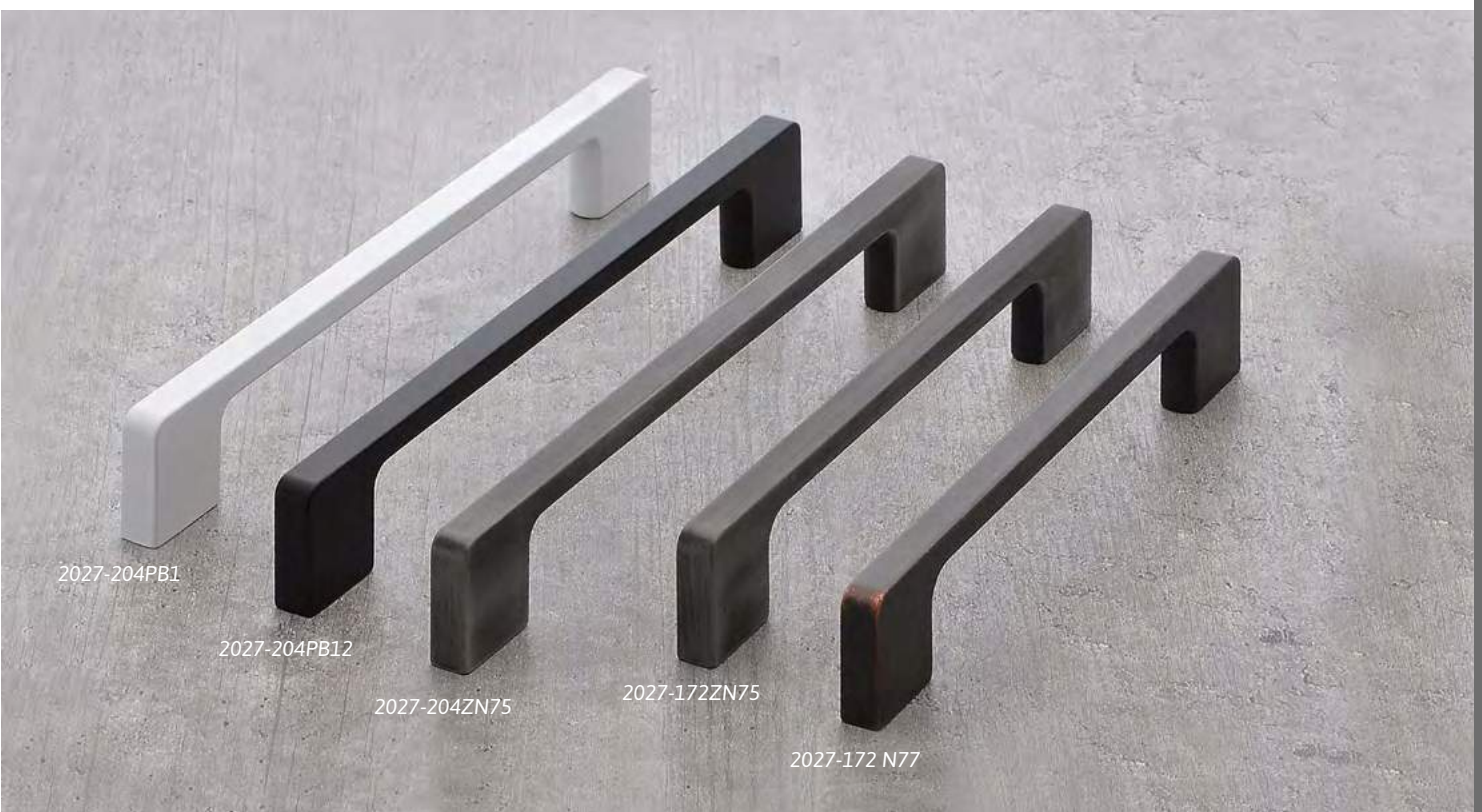

2027-204PB1

2027-204PB12

2027-204ZN75

2027-172ZN75

2027-172 N77

2021



Druckguss / die cast

Bestellnummer | Order no.  
 2021-119PB21  
 2021-119ZN1  
 2021-119ZN21



L	B/W	H	LA/CC	VE/PU
119	54	33	64	10

2014



Druckguss / die cast

Bestellnummer | Order no.  
 2014-136ZN1ZN35  
 2014-136ZN1ZN61



L	B/W	H	LA/CC	VE/PU
136	20	22	128	10

2013



Druckguss / die cast

Bestellnummer | Order no.  
 2013-39ZN1ZN35  
 2013-39ZN1ZN61



L	B/W	H	VE/PU
40	20	22	10

2011



Druckguss / die cast

Bestellnummer | Order no.  
 2011-50PB12  
 2011-50ZN1  
 2011-50ZN10  
 2011-50ZN21  
 2011-50ZN28  
 2011-60ZN21



L	B/W	H	D/S	VE/PU
50 60	20 22	40 45	20 22	10 10

2010



Druckguss / die cast

Bestellnummer | Order no.  
 2010-30ZN10



L	B/W	H	VE/PU
30	15	17	10



1987



Druckguss / die cast

Bestellnummer | Order no.  
1987-108ZN31  
1987-140ZN31



ZN31

L	B/W	H	LA/CC	VE/PU
108	26	22	96	10
140	26	22	128	10

1986



Druckguss / die cast

Bestellnummer | Order no.  
1986-44ZN31



ZN31

L	B/W	H	D/S	VE/PU
44	26	22	9	10

1973



Druckguss - Kunststoff / die cast - plastic

Bestellnummer | Order no.  
1973-106ZN1A4  
1973-106ZN29A4  
1973-106ZN31A78  
1973-138ZN1A4  
1973-138ZN29A4  
1973-138ZN31A78



ZN1A4



ZN29A4



ZN31A78

L	B/W	H	LA/CC	VE/PU
106	20	25	96	10
138	23	27	128	10

Passend zu 1979 Seite 305, 1980 Seite 304  
matching 1979 page 305, 1980 page 304

1972



Druckguss - Kunststoff / die cast - plastic

Bestellnummer | Order no.  
1972-32ZN1A4  
1972-32ZN29A4  
1972-32ZN31A78



ZN1A4



ZN29A4



ZN31A78

L	B/W	H	D/S	VE/PU
32	22	24	12	10

Passend zu 1979 Seite 305, 1980 Seite 304  
matching 1979 page 305, 1980 page 304

1971



Druckguss - Kunststoff / die cast - plastic

Bestellnummer | Order no.  
1971-23ZN1A4  
1971-23ZN29A4  
1971-23ZN31A78  
1971-30ZN1A4  
1971-30ZN29A4  
1971-30ZN31A78



ZN1A4



ZN29A4



ZN31A78

D	D/S	H	VE/PU
23	12	24	10
30	16	25	10

Passend zu 1979 Seite 305, 1980 Seite 304  
matching 1979 page 305, 1980 page 304

LOCHABSTAND | CENTER TO CENTER

LÄNGE | LENGTH

VERPACKUNGSEINHEIT | PACKING UNIT

BREITE | WIDTH

DURCHMESSER | DIAMETER

HÖHE | HEIGHT

1970



Druckguss / die cast

Bestellnummer | Order no.  
1970-68ZN31



ZN31



1969



Druckguss / die cast

Bestellnummer | Order no.  
1969-68ZN31



ZN31



1968



Druckguss / die cast

Bestellnummer | Order no.  
1968-162ZN51



ZN51



Abbildung: 1971-30ZN31A78 , 1973-106ZN31A78

1960



Druckguss / die cast

Bestellnummer | Order no.  
1960-25ZN3



ZN3

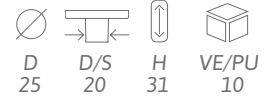

1959



Druckguss / die cast

Bestellnummer | Order no.  
1959-169ZN3



ZN3

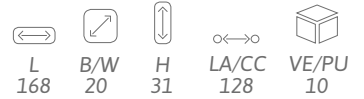

1958



Druckguss / die cast

Bestellnummer | Order no.  
1958-47ZN10  
1958-47ZN51



ZN10



ZN51

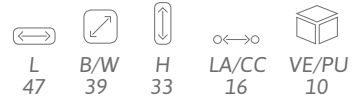

1957



Druckguss / die cast

Bestellnummer | Order no.  
1957-203ZN10  
1957-203ZN21  
1957-203ZN51



ZN10



ZN21



ZN51

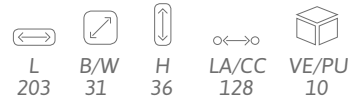

1956



Druckguss / die cast

Bestellnummer | Order no.  
1956-185PB21  
1956-185ZN1  
1956-185ZN21



PB21



ZN1



ZN21

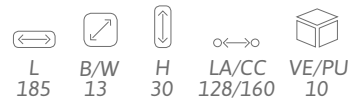



1935



Druckguss / die cast

Bestellnummer | Order no.  
1935-220ZN21



ZN21

L	B/W	H	LA/CC	VE/PU
220	20	24	192	10

1932



Druckguss / die cast

Bestellnummer | Order no.  
1932-138ZN1  
1932-138ZN21  
1932-178ZN1  
1932-178ZN21  
1932-260ZN1  
1932-260ZN21



ZN1



ZN21

L	B/W	H	LA/CC	VE/PU
138 180 260	28 34 25	33 32 32	96/128 128/160 192	10 10 10



Abbildung: 1935-220ZN21

1920

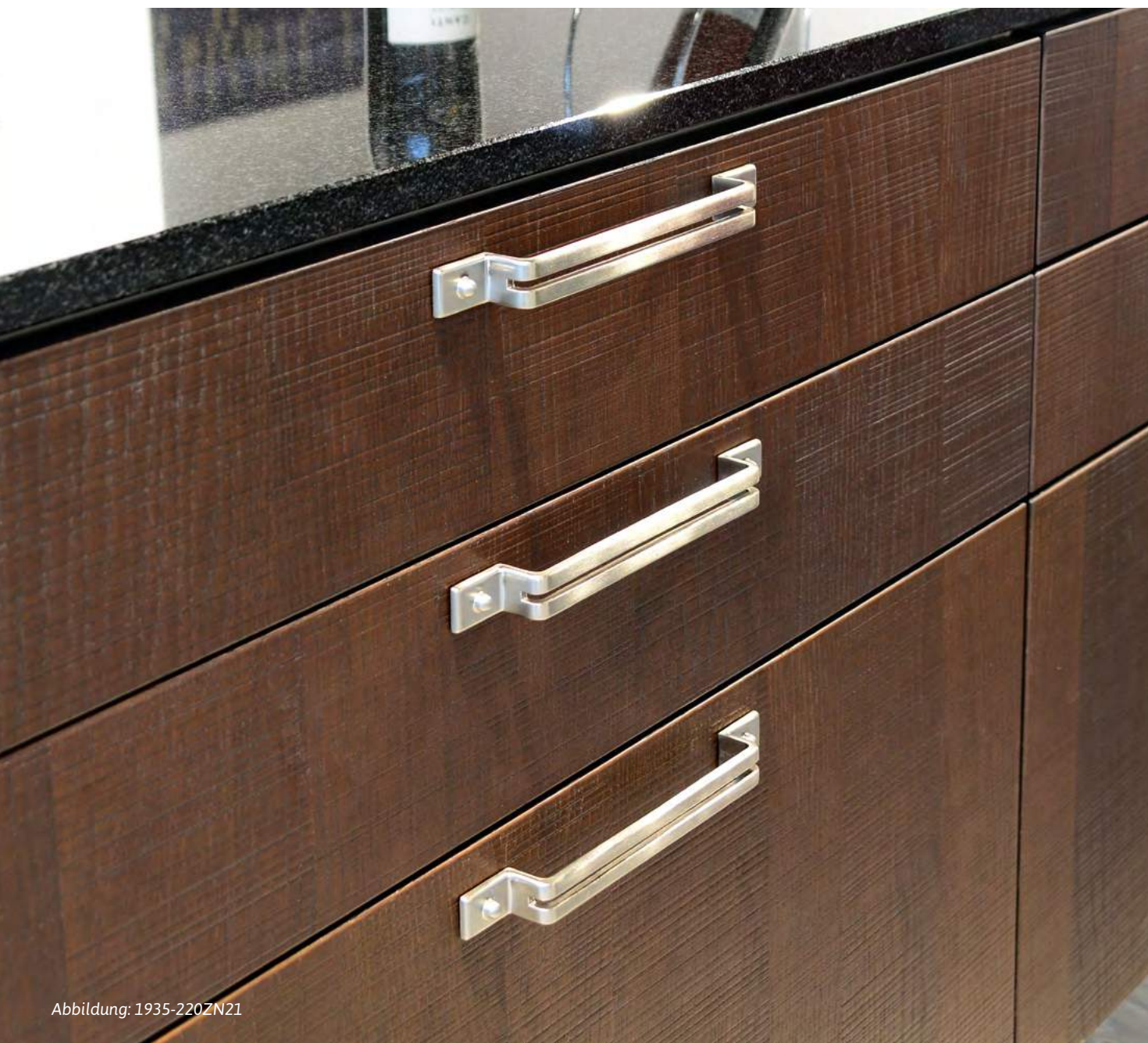

Druckguss / die cast

Bestellnummer | Order no.  
1920-90PB21  
1920-90ZN1



L 90  
 B/W 14  
 H 18  
 LA/CC 64  
 VE/PU 10

1919



Druckguss - Kunststoff / die cast - plastic

Bestellnummer | Order no.  
1919-34ZN28A4  
1919-34ZN31A78



D 34  
 D/S 18  
 H 30  
 VE/PU 10

1918



Druckguss - Kunststoff / die cast - plastic

Bestellnummer | Order no.  
1918-114ZN28A4  
1918-114ZN31A78



L 114  
 B/W 18  
 H 37  
 LA/CC 96  
 VE/PU 10

1917



Druckguss / die cast

Bestellnummer | Order no.  
1917-30ZN1  
1917-30ZN10  
1917-30ZN29  
1917-30ZN66



D 30  
 D/S 11  
 H 28  
 VE/PU 10

1916



Druckguss / die cast

Bestellnummer | Order no.  
1916-136ZN1  
1916-136ZN10  
1916-136ZN29



L 136  
 B/W 20  
 H 25  
 LA/CC 96  
 VE/PU 10



Abbildung: 1917-30ZN29, 1916-136ZN29

1908

In Deutschland nicht lieferbar / Not available in Germany



Druckguss / die cast

Bestellnummer | Order no.  
1908-42ZN1  
1908-42ZN21



ZN1

ZN21

L	B/W	H	LA/CC	VE/PU
42	11	28	32	10

1906F



Aluminium / aluminium

Bestellnummer | Order no.  
1906F-64AL1  
1906F-84AL1  
1906F-148AL1



AL1

L	B/W	H	LA/CC	VE/PU
64	12	23	32	10
84	12	23	64	10
148	12	23	128	10

1898



Druckguss - Kunststoff / die cast - plastic

Bestellnummer | Order no.  
1898-106ZN1A4  
1898-106ZN29A4  
1898-106ZN31A78  
1898-138ZN1A4  
1898-138ZN29A4  
1898-138ZN31A78



ZN1A4

ZN29A4

ZN31A78

L	B/W	H	LA/CC	VE/PU
106	20	26	96	10
138	23	27	128	10

Passend zu 1981, 1982 Seite 304  
matching 1981, 1982 page 304

1897



Druckguss - Kunststoff / die cast - plastic

Bestellnummer | Order no.  
1897-32ZN1A4  
1897-32ZN29A4  
1897-32ZN31A78



ZN1A4

ZN29A4

ZN31A78

L	B/W	H	D/S	VE/PU
32	22	24	12	10

Passend zu 1981, 1982 Seite 304  
matching 1981, 1982 page 304

1896



Druckguss - Kunststoff / die cast - plastic

Bestellnummer | Order no.  
1896-23ZN29A4  
1896-23ZN31A78  
1896-30ZN1A4  
1896-30ZN29A4  
1896-30ZN31A78



ZN1A4

ZN29A4

ZN31A78

D	D/S	H	VE/PU
23	12	24	10
30	16	27	10

Passend zu 1981, 1982 Seite 304  
matching 1981, 1982 page 304

LOCHABSTAND | CENTER TO CENTER

VERPACKUNGSEINHEIT | PACKING UNIT

DURCHMESSER | DIAMETER

LÄNGE | LENGTH

BREITE | WIDTH

HÖHE | HEIGHT

1889



Bestellnummer | Order no.  
1889-67ZN31A78



ZN31A78

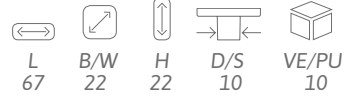

Druckguss - Kunststoff / die cast - plastic

1881



Bestellnummer | Order no.  
1881-130ZN31A78



ZN31A78



Druckguss - Kunststoff / die cast - plastic



Abbildung: 1896-30ZN1A4

1888



Druckguss / die cast

Bestellnummer | Order no.  
1888-40ZN1  
1888-40ZN50



ZN1

ZN50

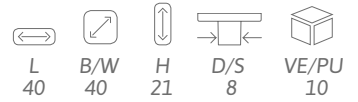

1887



Druckguss / die cast

Bestellnummer | Order no.  
1887-41ZN50



ZN50

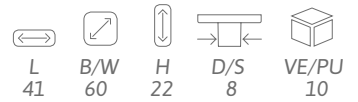

1886



Druckguss / die cast

Bestellnummer | Order no.  
1886-36ZN50



ZN50

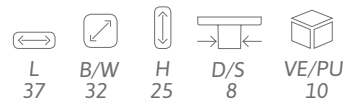

1885



Druckguss / die cast

Bestellnummer | Order no.  
1885-56ZN50



ZN50



1884



Druckguss / die cast

Bestellnummer | Order no.  
1884-48ZN50



ZN50

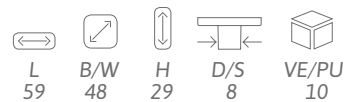

1883



Bestellnummer | Order no.  
1883-109ZN50



ZN50



L  
109



B/W  
38



H  
29



LA/CC  
76



VE/PU  
10

Druckguss / die cast

1882



Bestellnummer | Order no.  
1882-56ZN50



ZN50



L  
56



B/W  
59



H  
33



D/S  
8



VE/PU  
10

Druckguss / die cast

1874



Bestellnummer | Order no.  
1874-365ZN10



ZN10



L  
368



B/W  
38



H  
58



LA/CC  
128



VE/PU  
1

Druckguss / die cast

Passend zu 2088 Seite 364  
matching 2088 page 364



Abbildung: 1885-56ZN50, 1886-36ZN50

1837



Druckguss / die cast

Bestellnummer | Order no.  
1837-136ZN1



ZN1

L	B/W	H	LA/CC	VE/PU
136	14	33	128	10

1835



Druckguss / die cast

Bestellnummer | Order no.  
1835-68ZN31



ZN31

L	B/W	H	LA/CC	VE/PU
68	52	16	32	10

1816

In Polen nicht lieferbar / Not available in Poland



Druckguss / die cast

Bestellnummer | Order no.  
1816-44ZN4  
1816-44ZN21  
1816-44ZNS5  
1816-69ZN21  
1816-69ZNS5



ZN4



ZN21



ZNS5

L	B/W	H	LA/CC	VE/PU
44	58	11	0	10
69	58	11	32	10

Passend zu 1821 Seite 306  
matching 1821 page 306

1810



Druckguss / die cast

Bestellnummer | Order no.  
1810-80ZN10  
1810-116ZN10



ZN10

L	B/W	H	LA/CC	VE/PU
80	23	23	64	10
116	24	23	96	10

1809



Druckguss / die cast

Bestellnummer | Order no.  
1809-110ZN1  
1809-110ZN21  
1809-142ZN1  
1809-142ZN21



ZN1



ZN21

L	B/W	H	LA/CC	VE/PU
110	14	23	96	10
142	14	22	128	10



1808



Druckguss / die cast

Bestellnummer | Order no.  
1808-20ZN1  
1808-20ZN21

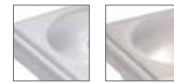

ZN1

ZN21

L	B/W	H	VE/PU
20	20	23	10

1791



Druckguss / die cast

Bestellnummer | Order no.  
1791-138PB21  
1791-138ZN1  
1791-138ZN21  
1791-202PB21  
1791-202ZN1  
1791-202ZN21



PB21

ZN1

ZN21

L	B/W	H	LA/CC	VE/PU
138 201	10 10	32 32	128 192	10 10



Abbildung: 1816-69ZN21

1784

In Holland, Belgien und Deutschland nicht lieferbar / Not available in Netherlands, Belgium and Germany



Aluminium / aluminium

Bestellnummer | Order no.  
 1784-110AL1  
 1784-110AL62  
 1784-110PB1  
 1784-110PB12  
 1784-110PBS22  
 1784-150AL1  
 1784-150AL62  
 1784-150PBS22



AL1

AL62

PB1

PB12



PBS22

L	B/W	H	LA/CC	VE/PU
110	13	27	94	10
150	21	34	136/122	10

1772



Druckguss / die cast

Bestellnummer | Order no.  
 1772-102ZN3



ZN3

L	B/W	H	LA/CC	VE/PU
102	12	27	96	10

1771

Rechtsausführung / right finish



Druckguss / die cast

Bestellnummer | Order no.  
 1771-127ZN21



ZN21

L	B/W	H	LA/CC	VE/PU
126	22	28	96	10

1770

Linksausführung / left finish



Druckguss / die cast

Bestellnummer | Order no.  
 1770-127ZN21



ZN21

L	B/W	H	LA/CC	VE/PU
126	22	28	96	10

1769



Druckguss / die cast

Bestellnummer | Order no.  
 1769-45ZN21



ZN21

L	B/W	H	D/S	VE/PU
45	33	29	8	10

LOCHABSTAND | CENTER TO CENTER

LÄNGE | LENGTH

VERPACKUNGSEINHEIT | PACKING UNIT

BREITE | WIDTH

DURCHMESSER | DIAMETER

HÖHE | HEIGHT

1768



Druckguss / die cast

Bestellnummer | Order no.  
1768-19ZN3



ZN3

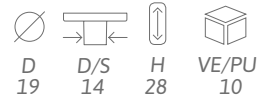

1767



Druckguss / die cast

Bestellnummer | Order no.  
1767-30ZN3  
1767-30ZN21



ZN3



ZN21

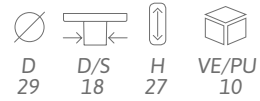

1766



Druckguss / die cast

Bestellnummer | Order no.  
1766-30ZN21



ZN21



Abbildung: 1771-127ZN21

1765

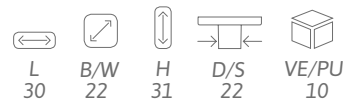

Druckguss / die cast

Bestellnummer | Order no.  
 1765-135ZN1  
 1765-157ZN1  
 1765-157ZN21

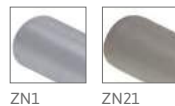

ZN1

ZN21

L	B/W	H	LA/CC	VE/PU
135	10	27	96	10
157	10	28	128	10

1764



Druckguss / die cast

Bestellnummer | Order no.  
 1764-123ZN3



ZN3

L	B/W	H	LA/CC	VE/PU
123	16	27	96	10

1763



Druckguss / die cast

Bestellnummer | Order no.  
 1763-118ZN27



ZN27

L	B/W	H	LA/CC	VE/PU
118	15	25	96	10

1762



Druckguss / die cast

Bestellnummer | Order no.  
 1762-132ZN3  
 1762-174ZN3



ZN3

L	B/W	H	LA/CC	VE/PU
130	24	27	96	10
174	24	27	128	10

1761



Druckguss / die cast

Bestellnummer | Order no.  
 1761-103ZN27  
 1761-103ZN75  
 1761-103ZN79



ZN27

ZN75

ZN79

L	B/W	H	LA/CC	VE/PU
104	32	25	64	10

1760



Bestellnummer | Order no.  
1760-85PB12  
1760-85ZN3  
1760-85ZN10  
1760-85ZN29



PB12

ZN3

ZN10

ZN29



L  
85



B/W  
31



H  
27



LA/CC  
64



VE/PU  
10

Druckguss / die cast



Abbildung: 1760-85PB12

1757

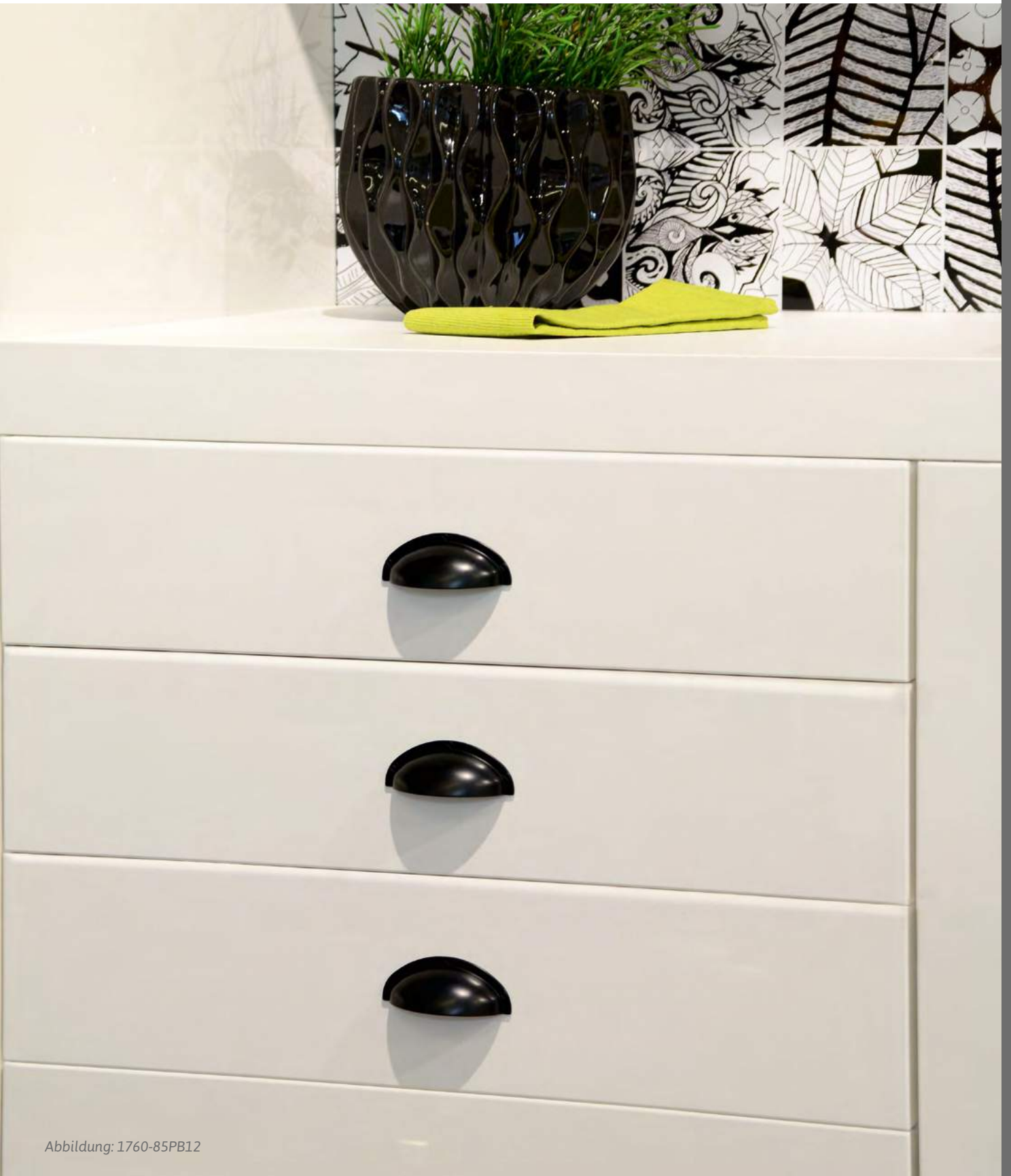

Druckguss / die cast

Bestellnummer | Order no.  
 1757-105ZN28  
 1757-105ZN10V2\*  
 1757-105ZN28V2\*

\* Bestellnr. für 2 Stück / order no. for 2 pcs.  
 VE / MOQ : 5 = 10 Stück / pieces



L	B/W	H	LA/CC	VE/PU
105	17	30	96	10
*105	17	30	96	5

1756



Druckguss / die cast

Bestellnummer | Order no.  
 1756-46ZN10  
 1756-46ZN28  
 1756-46ZN10V2\*  
 1756-46ZN28V2\*

\* Bestellnr. für 2 Stück / order no. for 2 pcs.  
 VE / MOQ : 5 = 10 Stück / pieces



L	B/W	H	VE/PU
42	46	18	10
* 42	46	18	5

1709



Druckguss / die cast

Bestellnummer | Order no.  
 1709-54ZN10V2\*

\* Bestellnr. für 2 Stück / order no. for 2 pcs.  
 VE / MOQ : 5 = 10 Stück / pieces



L	B/W	H	VE/PU
54	19	19	5

1706



Druckguss / die cast

Bestellnummer | Order no.  
 1706-84ZN28  
 1706-84ZN10V2\*  
 1706-84ZN28V2\*

\* Bestellnr. für 2 Stück / order no. for 2 pcs.  
 VE / MOQ : 5 = 10 Stück / pieces



L	B/W	H	LA/CC	VE/PU
84	48	17	64	10
* 84	48	17	64	5

1705



Druckguss / die cast

Bestellnummer | Order no.  
 1705-55ZN10V2\*  
 1705-55ZN28V2\*

\* Bestellnr. für 2 Stück / order no. for 2 pcs.  
 VE / MOQ : 5 = 10 Stück / pieces



L	B/W	H	VE/PU
55	36	21	5

1704



Druckguss / die cast

Bestellnummer | Order no.  
1704-118ZN10V2\*  
1704-118ZN28V2\*



ZN10 ZN28

L	B/W	H	LA/CC	VE/PU
118	40	20	96	5

\* Bestellnr. für 2 Stück / order no. for 2 pcs.  
VE / MOQ : 5 = 10 Stück / pieces

1702



Druckguss / die cast

Bestellnummer | Order no.  
1702-108ZN28  
1702-108ZN10V2\*  
1702-108ZN28V2\*



ZN10 ZN28

L	B/W	H	VE/PU
108	31	31	10
* 108	31	31	5

\* Bestellnr. für 2 Stück / order no. for 2 pcs.  
VE / MOQ : 5 = 10 Stück / pieces

1701



Druckguss / die cast

Bestellnummer | Order no.  
1701-31ZN28  
1701-31ZN10V2\*  
1701-31ZN28V2\*



ZN10 ZN28

D	D/S	H	VE/PU
31	11	29	10
* 31	11	29	5

\* Bestellnr. für 2 Stück / order no. for 2 pcs.  
VE / MOQ : 5 = 10 Stück / pieces



Abbildung: 1757-105ZN10V2\*

1750



Druckguss / die cast

Bestellnummer | Order no.  
 1750-193PB21  
 1750-193ZN1  
 1750-193ZN21



PB21

ZN1

ZN21

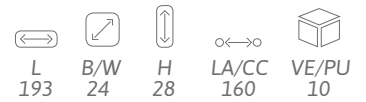

1748



Druckguss / die cast

Bestellnummer | Order no.  
 1748-232PB21  
 1748-232ZN21



PB21

ZN21

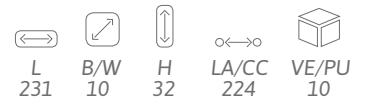

1746



Druckguss / die cast

Bestellnummer | Order no.  
 1746-35PB21  
 1746-35ZN1  
 1746-35ZN21  
 1746-35ZN74  
 1746-40ZN21



PB21

ZN1

ZN21

ZN74

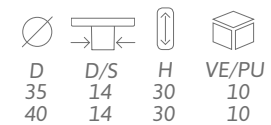

1745



Druckguss / die cast

Bestellnummer | Order no.  
 1745-47ZN1  
 1745-47ZN21



ZN1

ZN21



Passend zu 1668 Seite 110  
 matching 1668 page 110

1700



Druckguss - Keramik / die cast - ceramic

Bestellnummer | Order no.  
 1700-29ZN48PC5  
 1700-29ZN48PF21



ZN48PC5

ZN48PF21

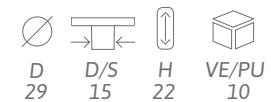



1699



Druckguss - Keramik / die cast - ceramic

Bestellnummer | Order no.  
1699-107ZN10PC6  
1699-107ZN48PC5  
1699-107ZN48PF21



ZN10PC6 ZN48PC5 ZN48PF21

L	B/W	H	LA/CC	VE/PU
107	19	26	96	10

1697



Druckguss / die cast

Bestellnummer | Order no.  
1697-376ZN10



ZN10

L	B/W	H	LA/CC	VE/PU
376	33	56	288	1

1696



Druckguss / die cast

Bestellnummer | Order no.  
1696-335ZN10  
1696-335ZN46

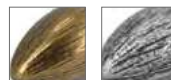

ZN10 ZN46

L	B/W	H	LA/CC	VE/PU
333	27	50	272	1



Abbildung: 1697-376ZN10

1692



Druckguss / die cast

Bestellnummer | Order no.  
1692-138ZN4  
1692-138ZN21



ZN4

ZN21

L	B/W	H	LA/CC	VE/PU
138	38	39	128	10

1682



Druckguss / die cast

Bestellnummer | Order no.  
1682-83ZN10  
1682-83ZN29



ZN10

ZN29

L	B/W	H	LA/CC	VE/PU
83	63	26	32	10

Beschriftungsmöglichkeit / possibility to letter

1681



Druckguss / die cast

Bestellnummer | Order no.  
1681-144ZN10  
1681-144ZN29  
1681-144ZN66



ZN10

ZN29

ZN66

L	B/W	H	LA/CC	VE/PU
144	36	30	96	10

1671



Druckguss / die cast

Bestellnummer | Order no.  
1671-152PB21  
1671-152ZN1  
1671-152ZN21  
1671-232PB21  
1671-232ZN1  
1671-232ZN21



PB21

ZN1

ZN21

L	B/W	H	LA/CC	VE/PU
151 232	20 19	30 30	96/128 224	10 10

1668



Druckguss / die cast

Bestellnummer | Order no.  
1668-200ZN21



ZN21

L	B/W	H	LA/CC	VE/PU
200	40	36	160	10

Passend zu 1745 Seite 108  
matching 1745 page 108

LOCHABSTAND | CENTER TO CENTER

VERPACKUNGSEINHEIT | PACKING UNIT

DURCHMESSER | DIAMETER

LÄNGE | LENGTH

BREITE | WIDTH

HÖHE | HEIGHT

1667



Druckguss / die cast

Bestellnummer | Order no.  
1667-331ZN1



ZN1



L  
332



B/W  
16



H  
31



LA/CC  
320



VE/PU  
10

1666



Druckguss / die cast

Bestellnummer | Order no.  
1666-136PB21  
1666-136ZN1  
1666-136ZN21  
1666-232PB21  
1666-232ZN1  
1666-232ZN21



PB21



ZN1



ZN21



L  
136  
232



B/W  
16  
16



H  
23  
22



LA/CC  
128  
224



VE/PU  
10  
10



Abbildung: 1681-144ZN29

1663



Druckguss / die cast

Bestellnummer | Order no.  
1663-160ZN21



ZN21

L	B/W	H	LA/CC	VE/PU
160	30	12	128	10

1661



Druckguss - Holz / die cast - wood

Bestellnummer | Order no.  
1661-169PB21HZ18



PB21HZ18

L	B/W	H	LA/CC	VE/PU
169	18	30	160	10

1652



Druckguss / die cast

Bestellnummer | Order no.  
1652-35PB21  
1652-35ZN1  
1652-35ZN4  
1652-35ZN5  
1652-35ZN21



PB21

ZN1

ZN4

ZN5



ZN21

L	B/W	H	VE/PU
34	16	26	10

Passend zu 1653, 1654 Seite 310  
matching 1653, 1654 page 310

1651



Druckguss / die cast

Bestellnummer | Order no.  
1651-113PB21  
1651-113ZN1  
1651-113ZN4  
1651-113ZN5  
1651-113ZN21  
1651-150PB21  
1651-150ZN1  
1651-150ZN4  
1651-150ZN21



PB21

ZN1

ZN4

ZN5



ZN21

L	B/W	H	LA/CC	VE/PU
112 150	15 16	30 29	96 128	10 10

1624



Aluminium / aluminium

Bestellnummer | Order no.  
1624-16AL1



AL1

D	D/S	H	VE/PU
16	8	25	10



Abbildung: 1663-160ZN21

1636



Druckguss / die cast

Bestellnummer | Order no.  
1636-48ZN29



ZN29

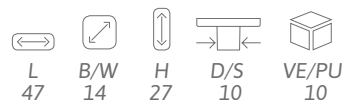

1635



Druckguss / die cast

Bestellnummer | Order no.  
1635-33ZN10  
1635-33ZN29



ZN10



ZN29



1634



Druckguss / die cast

Bestellnummer | Order no.  
1634-40ZN10



ZN10

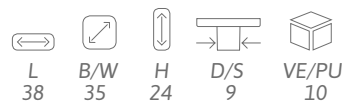

1633



Druckguss / die cast

Bestellnummer | Order no.  
1633-35ZN10



ZN10

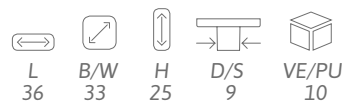

1632



Druckguss / die cast

Bestellnummer | Order no.  
1632-35ZN10  
1632-35ZN29



ZN10



ZN29

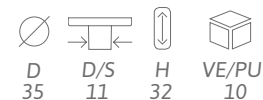

1631



Druckguss / die cast

Bestellnummer | Order no.  
1631-140ZN10  
1631-140ZN29

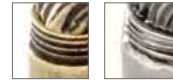

ZN10

ZN29

L	B/W	H	LA/CC	VE/PU
140	13	34	128	10



Abbildung: 1632-35ZN29, 1631-140ZN29

1602



Druckguss / die cast

Bestellnummer | Order no.  
1602-40PB21  
1602-40ZN1  
1602-40ZN4



PB21 ZN1 ZN4

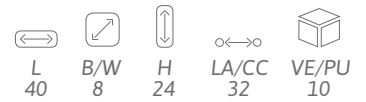

L 40 B/W 8 H 24 LA/CC 32 VE/PU 10

1601



Druckguss / die cast

Bestellnummer | Order no.  
1601-40PB21  
1601-40ZN1  
1601-40ZN4  
1601-40ZN5  
1601-40ZN21



PB21 ZN1 ZN4 ZN5



ZN21

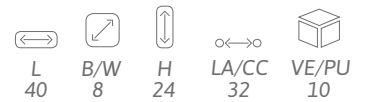

L 40 B/W 8 H 24 LA/CC 32 VE/PU 10

1600



Druckguss / die cast

Bestellnummer | Order no.  
1600-36PB21  
1600-36ZN4



PB21 ZN4



L 36 B/W 16 H 15 VE/PU 10

1597



Druckguss / die cast

Bestellnummer | Order no.  
1597-52PB21  
1597-52ZN1  
1597-52ZN4

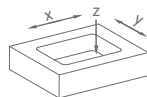

x 48  
y 19  
z 14



PB21 ZN1 ZN4



L 52 B/W 23 H 16 VE/PU 10

1592



Druckguss / die cast

Bestellnummer | Order no.  
1592-52PB21  
1592-52ZN1  
1592-52ZN4

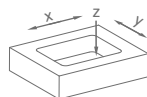

x 48  
y 19  
z 14



PB21 ZN1 ZN4



L 52 B/W 23 H 15 VE/PU 10





1592-52ZN4



1592-52ZN1



1592-52PB21



1601-40PB21



1601-40ZN4



1601-40ZN21



1601-40ZN1



1602-40ZN4



1602-40ZN1



1602-40PB21



1600-36PB21



1600-36ZN4



1597-52ZN4



1597-52ZN1



1597-52PB21

1596



Druckguss / die cast

Bestellnummer | Order no.  
 1596-40PB21  
 1596-40ZN1  
 1596-40ZN4  
 1596-40ZN21



1595



Druckguss / die cast

Bestellnummer | Order no.  
 1595-29PB1  
 1595-29PB12  
 1595-29PB21  
 1595-29ZN1  
 1595-29ZN4  
 1595-29ZN5  
 1595-29ZN21  
 1595-29ZN75  
 1595-29ZN79

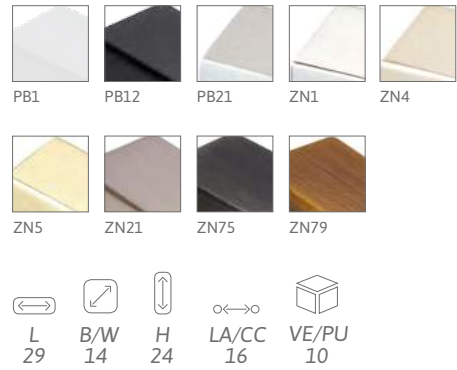

1588



Druckguss / die cast

Bestellnummer | Order no.  
 1588-57PB21  
 1588-57ZN1

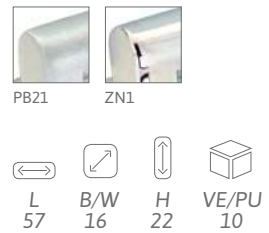

1587



Druckguss / die cast

Bestellnummer | Order no.  
 1587-128ZN31

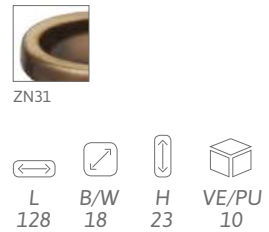

1586



Druckguss - Kunststoff / die cast - plastic

Bestellnummer | Order no.  
 1586-80PB21A3  
 1586-80PB21A4  
 1586-80ZN1A3  
 1586-80ZN1A4  
 1586-80ZN4A3  
 1586-80ZN21A3  
 1586-80ZN21A4





Abbildung: 1595-29PB12

Abbildung: 1596-40ZN21

1583



Druckguss / die cast

Bestellnummer | Order no.  
 1583-16PB21  
 1583-16ZN1  
 1583-16ZN5  
 1583-16ZN21

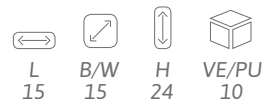
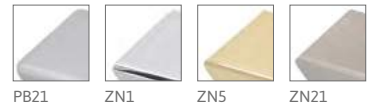

1583



Druckguss - Kunststoff / die cast - plastic

Bestellnummer | Order no.  
 1583-22ZN1KGS1



ZN1KGS1

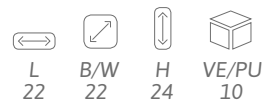

1582



Druckguss / die cast

Bestellnummer | Order no.  
 1582-112PB21  
 1582-112ZN1  
 1582-112ZN21

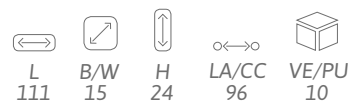

1581



Druckguss / die cast

Bestellnummer | Order no.  
 1581-16PB21  
 1581-16ZN1  
 1581-16ZN5  
 1581-16ZN21

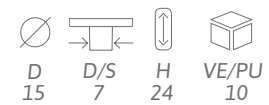

1580



Druckguss / die cast

Bestellnummer | Order no.  
 1580-112PB21  
 1580-112ZN1  
 1580-112ZN21

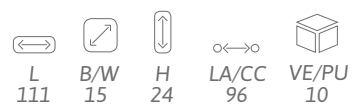

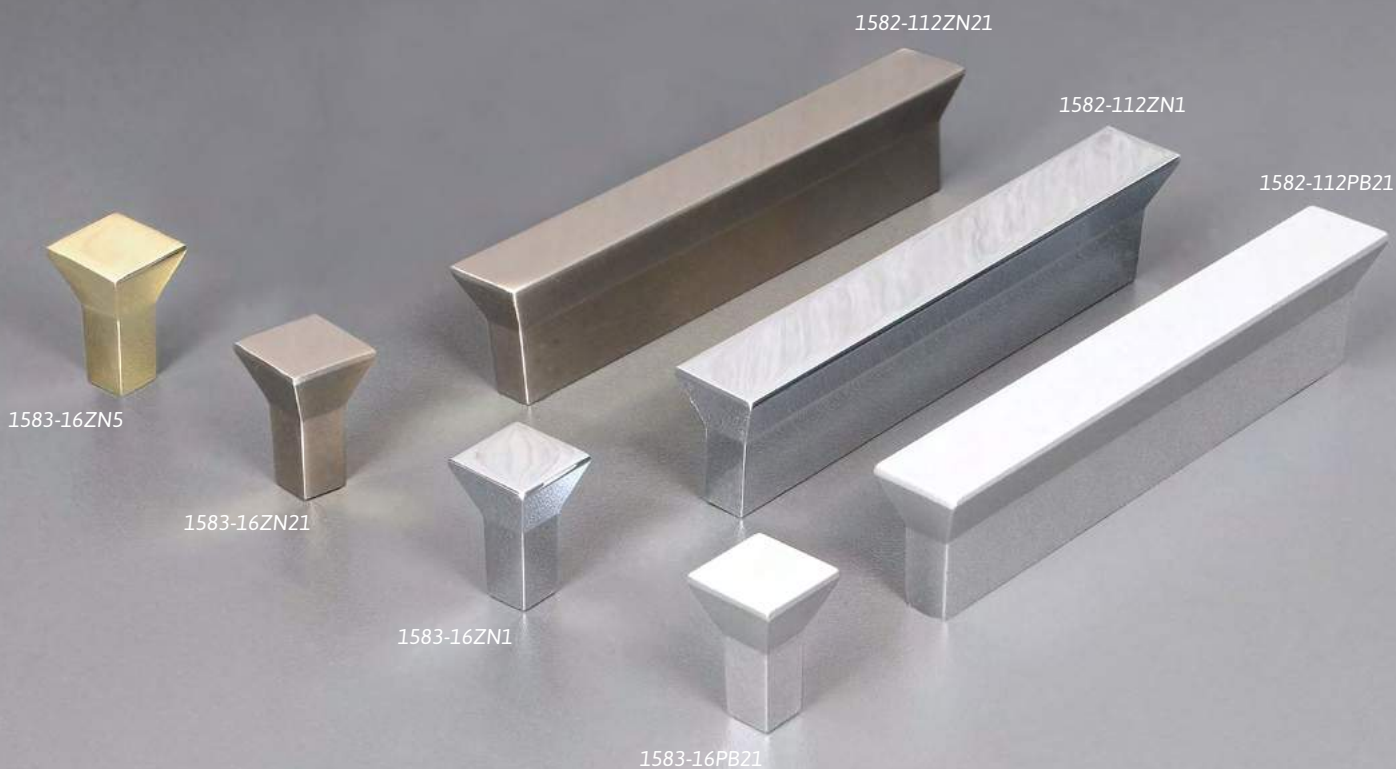

1579



Druckguss / die cast

Bestellnummer | Order no.  
1579-37ZN10  
1579-37ZN29



ZN10

ZN29

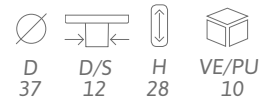

1578



Druckguss / die cast

Bestellnummer | Order no.  
1578-43ZN10  
1578-43ZN29



ZN10

ZN29

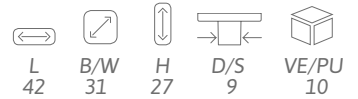

1577



Druckguss / die cast

Bestellnummer | Order no.  
1577-110ZN10  
1577-110ZN29



ZN10

ZN29

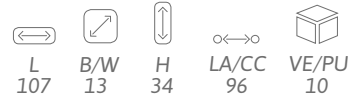

1576



Druckguss / die cast

Bestellnummer | Order no.  
1576-12PB21  
1576-12ZN1  
1576-12ZN4  
1576-12ZN5  
1576-12ZN21



PB21

ZN1

ZN4

ZN5



ZN21

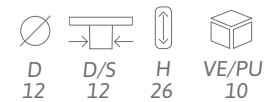

1567



Druckguss / die cast

Bestellnummer | Order no.  
1567-110ZN43



ZN43

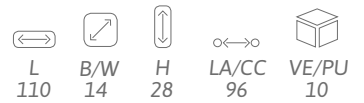

1563



Bestellnummer | Order no.  
1563-180PB21



PB21



L  
180



B/W  
44



H  
19



LA/CC  
160



VE/PU  
10

Druckguss / die cast



Abbildung: 1577-110ZN10, 1579-37ZN10

1549



Druckguss / die cast

Bestellnummer | Order no.  
1549-50ZN10  
1549-50ZN29



ZN10

ZN29



1548



Druckguss / die cast



Bestellnummer | Order no.  
1548-18PB21  
1548-18ZN1  
1548-18ZN10  
1548-18ZN29



PB21

ZN1

ZN10

ZN29

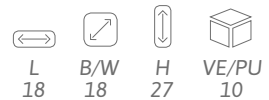

1537



Druckguss / die cast

Bestellnummer | Order no.  
1537-115ZN10  
1537-115ZN29

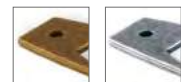

ZN10

ZN29

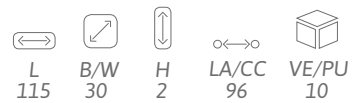

1536



Druckguss / die cast

Bestellnummer | Order no.  
1536-122ZN10  
1536-122ZN29



ZN10

ZN29

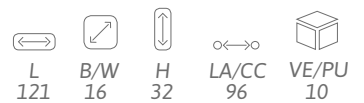

1546



Druckguss / die cast

Bestellnummer | Order no.  
1546-137ZN10  
1546-137ZN29



ZN10

ZN29

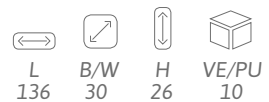



1543



Bestellnummer | Order no.  
 1543-189ZN1  
 1543-189ZN10  
 1543-189ZN29



L 190	B/W 21	H 28	LA/CC 128	VE/PU 10

Druckguss / die cast

1542



Bestellnummer | Order no.  
 1542-88ZN1  
 1542-88ZN10  
 1542-88ZN29



L 88	B/W 19	H 38	D/S 10	VE/PU 10

Druckguss / die cast

1541



Bestellnummer | Order no.  
 1541-118ZN5



L 118	B/W 10	H 33	LA/CC 96	VE/PU 10

Druckguss / die cast



Abbildung: 1546-137ZN29

1540



Aluminium / aluminium

Bestellnummer | Order no.  
1540-52AL1



AL1

L	B/W	H	LA/CC	VE/PU
52	7	20	32	10

1538



Druckguss / die cast

Bestellnummer | Order no.  
1538-152PB21  
1538-175ZN21



PB21

ZN21

L	B/W	H	LA/CC	VE/PU
152 174	46 46	17 17	128 160	10 10

1535



Druckguss / die cast

Bestellnummer | Order no.  
1535-52PB21  
1535-52ZN1  
1535-52ZN4



PB21

ZN1

ZN4

L	B/W	H	VE/PU	
51	16	17	10	

1534



Druckguss / die cast

Bestellnummer | Order no.  
1534-130PB12  
1534-130ZN9  
1534-130ZN10  
1534-130ZN29

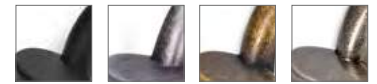

PB12

ZN9

ZN10

ZN29

L	B/W	H	LA/CC	VE/PU
129	30	27	96	10

1533



Druckguss / die cast

Bestellnummer | Order no.  
1533-33PB12  
1533-33ZN9  
1533-33ZN10  
1533-33ZN29  
1533-33ZN83



PB12

ZN9

ZN10

ZN29



ZN83

D	D/S	H	VE/PU
32	24	28	10

1532







Stahl / steel

Bestellnummer | Order no.  
1532-138ZN2



ZN2

				
L 138	B/W 10	H 35	LA/CC 128	VE/PU 10

1529



Aluminium / aluminium

Bestellnummer | Order no.  
1529-146AL1



AL1





				
L 146	B/W 20	H 29	LA/CC 128	VE/PU 10



Abbildung: 1534-130PB12, 1533-33PB12

1528



Aluminium / aluminium

Bestellnummer | Order no.  
1528-138AL1



AL1

L	B/W	H	LA/CC	VE/PU
138	20	30	128	10

1527



Aluminium / aluminium

Bestellnummer | Order no.  
1527-143AL1



AL1

L	B/W	H	LA/CC	VE/PU
144	10	33	128	10

1518



Druckguss / die cast

Bestellnummer | Order no.  
1518-110PB21  
1518-110ZN1  
1518-110ZN21  
1518-142PB21  
1518-174PB21



PB21



ZN1



ZN21

L	B/W	H	LA/CC	VE/PU
110	20	19	96	10
142	20	19	128	10
174	20	19	160	10

1517



Druckguss / die cast

Bestellnummer | Order no.  
1517-116PB21  
1517-148PB21  
1517-180PB21  
1517-212PB21



PB21

L	B/W	H	LA/CC	VE/PU
116	20	20	96	10
148	20	20	128	10
180	20	20	160	10
212	20	20	192	10

1516



Druckguss / die cast

Bestellnummer | Order no.  
1516-116ZN1  
1516-154ZN1  
1516-154ZN21



ZN1



ZN21

L	B/W	H	LA/CC	VE/PU
116	20	26	96	10
154	20	26	128	10

1515



Druckguss / die cast

Bestellnummer | Order no.  
 1515-76PB21  
 1515-140PB21  
 1515-236PB21  
 1515-364PB21  
 1515-428PB21  
 1515-524PB21



PB21

L	B/W	H	LA/CC	VE/PU
76	15	32	32	10
140	15	32	96	10
236	15	32	192	10
364	15	32	2x160	5
428	15	32	2x192	5
524	15	32	2x240	5

1509



Druckguss / die cast

Bestellnummer | Order no.  
 1509-112PB21



PB21

L	B/W	H	LA/CC	VE/PU
112	20	21	96	10



Abbildung: 1515-140PB21

1506



Druckguss / die cast

Bestellnummer | Order no.  
1506-30PB21  
1506-30ZN1



PB21

ZN1



1505



Druckguss / die cast

Bestellnummer | Order no.  
1505-30ZN1



ZN1

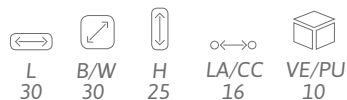

1504



Druckguss / die cast

Bestellnummer | Order no.  
1504-30PB21  
1504-30ZN1



PB21

ZN1



1504



Druckguss / die cast

Bestellnummer | Order no.  
1504-30ZN1ZN61



ZN1ZN61



1503



Druckguss / die cast

Bestellnummer | Order no.  
1503-24PB21  
1503-24ZN1  
1503-24ZN4  
1503-24ZN5  
1503-24ZN21



PB21

ZN1

ZN4

ZN5



ZN21

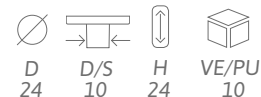



METALL metal

Abbildung: 1504-30PB21

1502



Druckguss / die cast

Bestellnummer | Order no.  
 1502-20PB21  
 1502-20ZN1  
 1502-20ZN4  
 1502-20ZN21



1500



Druckguss / die cast

Bestellnummer | Order no.  
 1500-16PB21  
 1500-16ZN1  
 1500-16ZN4  
 1500-16ZN5  
 1500-16ZN21

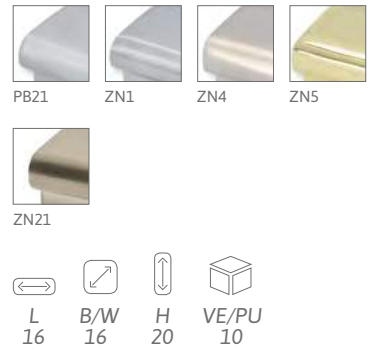

1499



Druckguss / die cast

Bestellnummer | Order no.  
 1499-16PB21  
 1499-16ZN1  
 1499-16ZN4  
 1499-16ZN5  
 1499-16ZN21  
 1499-16ZN78  
 1499-16ZN79

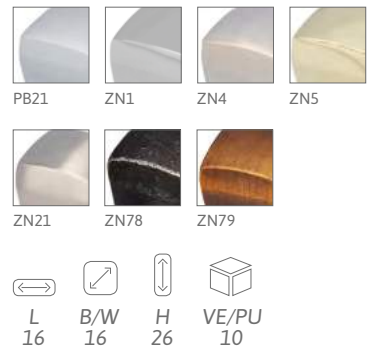

1498



Druckguss / die cast

Bestellnummer | Order no.  
 1498-32PB21  
 1498-32ZN1  
 1498-32ZN4  
 1498-32ZN21

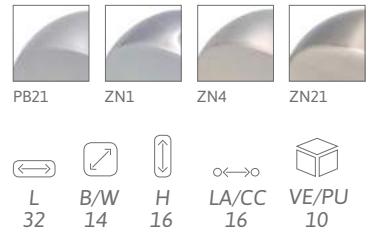

1497



Druckguss / die cast

Bestellnummer | Order no.  
 1497-30PB21  
 1497-30ZN1  
 1497-30ZN4  
 1497-30ZN5  
 1497-30ZN21

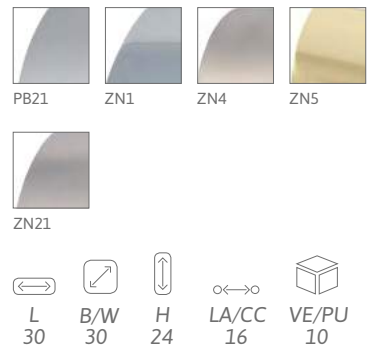





METALL metal

Abbildung: 1499-16ZN21

1493



Druckguss / die cast

Bestellnummer | Order no.  
 1493-148ZN1  
 1493-148ZN2  
 1493-148ZN21



L	B/W	H	LA/CC	VE/PU
149	20	28	128	10

1488



Aluminium - Kunststoff mit M4 Gewinde /  
 aluminium - plastic with M4 thread

Bestellnummer | Order no.  
 1488-140AL1MV11  
 1488-172AL1MV11  
 1488-204AL1MV11



AL1MV11

L	B/W	H	LA/CC	VE/PU
140	26	32	128	10
172	26	32	160	10
204	26	32	192	10

1485



Druckguss / die cast

Bestellnummer | Order no.  
 1485-178ZN1  
 1485-178ZN4  
 1485-178ZN40



L	B/W	H	LA/CC	VE/PU
178	19	24	128	10

1480



Aluminium / aluminium

Bestellnummer | Order no.  
 1480-146AL1



AL1

L	B/W	H	LA/CC	VE/PU
146	20	28	128	10

1478



Aluminium / aluminium

Bestellnummer | Order no.  
 1478-140AL1  
 1478-172AL1  
 1478-204AL1  
 1478-300AL1  
 1478-364AL1  
 1478-460AL1



AL1

L	B/W	H	LA/CC	VE/PU
140	16	36	128	10
172	16	36	160	10
204	16	36	192	10
300	16	36	288	10
364	16	36	352	10
460	16	36	448	5

↔ LOCHABSTAND | CENTER TO CENTER

↔ LÄNGE | LENGTH

📦 VERPACKUNGSEINHEIT | PACKING UNIT

↔ BREITE | WIDTH

⌀ DURCHMESSER | DIAMETER

↕ HÖHE | HEIGHT

1474



ZN10

ZN29



Bestellnummer | Order no.  
1474-143ZN10  
1474-143ZN29

L	B/W	H	VE/PU
142	25	23	10

Druckguss / die cast



Abbildung: 1488-204AL1MV11

1427



Druckguss / die cast

Bestellnummer | Order no.  
1427-40ZN1  
1427-40ZN2

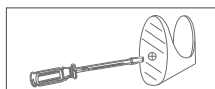

Auch als Haken verwendbar!  
Can be also used as hook!



ZN1

ZN2

L 39	B/W 24	H 30	VE/PU 10

1426



Druckguss / die cast

Bestellnummer | Order no.  
1426-40ZN1  
1426-40ZN2

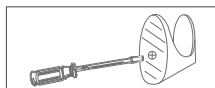

Auch als Haken verwendbar!  
Can be also used as hook!



ZN1

ZN2

L 40	B/W 22	H 30	VE/PU 10

1425



Druckguss / die cast

Bestellnummer | Order no.  
1425-40ZN1  
1425-40ZN2

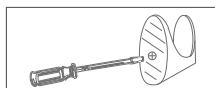

Auch als Haken verwendbar!  
Can be also used as hook!



ZN1

ZN2

L 40	B/W 40	H 30	VE/PU 10

1424



Druckguss / die cast

Bestellnummer | Order no.  
1424-40ZN1  
1424-40ZN2  
1424-40ZN21

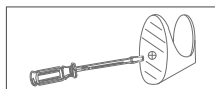

Auch als Haken verwendbar!  
Can be also used as hook!



ZN1

ZN2

ZN21

L 39	B/W 22	H 30	VE/PU 10

1368



Druckguss / die cast

Bestellnummer | Order no.  
1368-33ZN10  
1368-33ZN36  
1368-42ZN10  
1368-42ZN36



ZN10

ZN36

D 33 42	D/S 10 12	H 23 27	VE/PU 10 10

1367



Druckguss / die cast

Bestellnummer | Order no.  
1367-120ZN10  
1367-120ZN36



ZN10 ZN36



1366



Druckguss / die cast

Bestellnummer | Order no.  
1366-41ZN10  
1366-41ZN36



ZN10 ZN36



1365



Druckguss / die cast

Bestellnummer | Order no.  
1365-153ZN10  
1365-153ZN36



ZN10 ZN36



Abbildung: 1365-153ZN36, 1368-33ZN36

1349

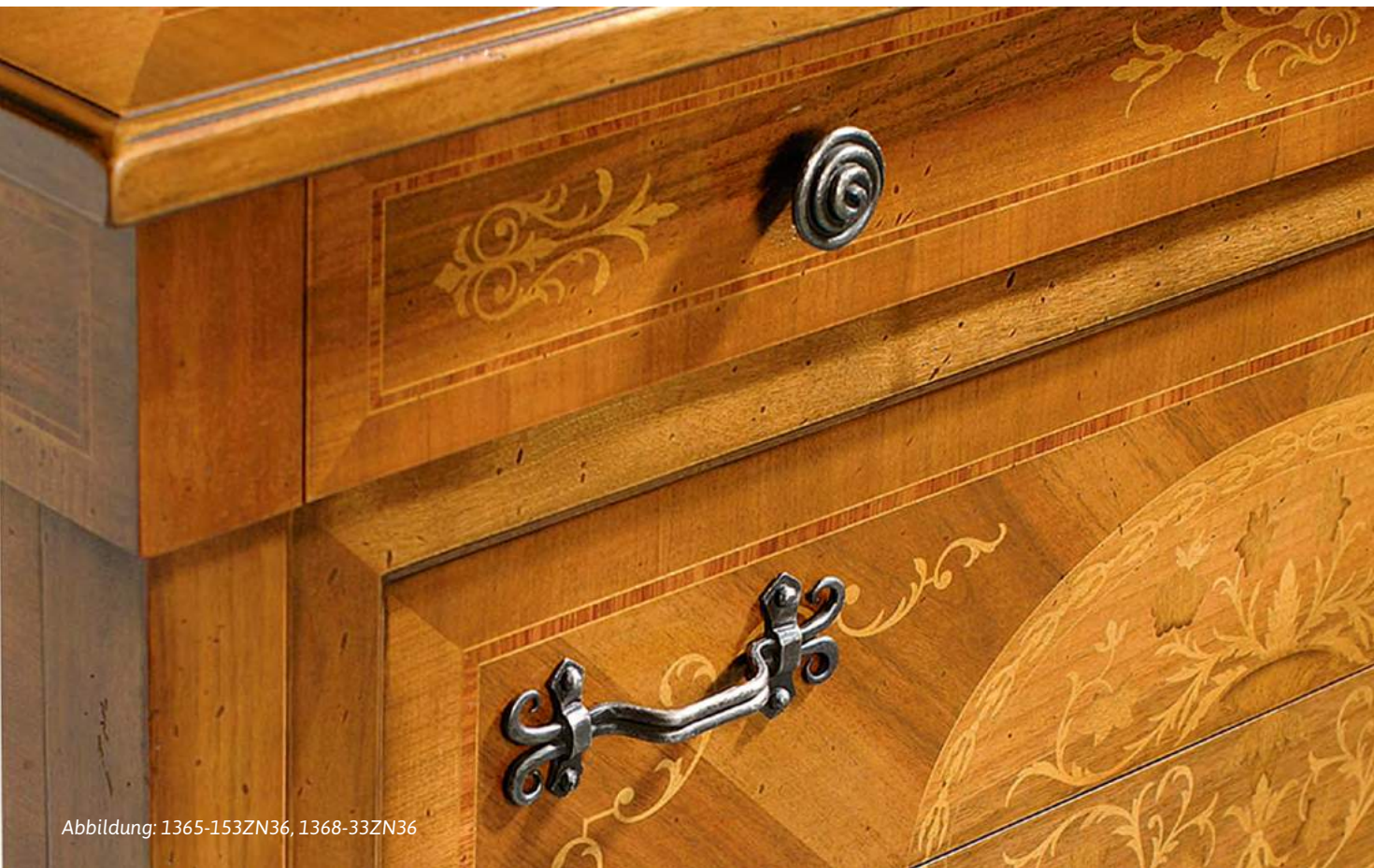

Druckguss / die cast

Bestellnummer | Order no.  
1349-25ZN10



ZN10

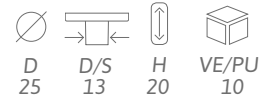

1340



Druckguss / die cast

Bestellnummer | Order no.  
1340-134ZN1ZN34  
1340-134ZN2ZN35  
1340-134ZN32ZN33  
1340-134ZN37ZN35



ZN1ZN34 ZN2ZN35 ZN32ZN33 ZN37ZN35

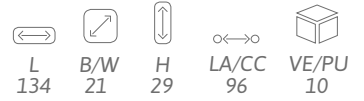

1339



Druckguss / die cast

Bestellnummer | Order no.  
1339-35ZN1ZN34  
1339-35ZN2ZN35  
1339-35ZN32ZN33

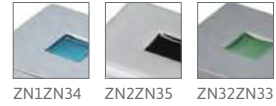

ZN1ZN34 ZN2ZN35 ZN32ZN33

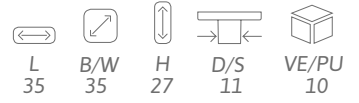

1332



Druckguss / die cast

Bestellnummer | Order no.  
1332-12ZN1



ZN1

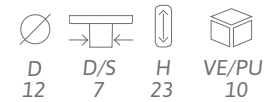

1329



Druckguss / die cast

Bestellnummer | Order no.  
1329-145ZN21



ZN21

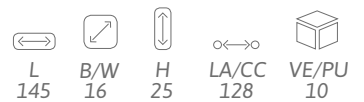

1324



Druckguss / die cast

Bestellnummer | Order no.  
1324-31PB1  
1324-31PB21  
1324-31ZN21



Abbildung: 1339-35ZN1ZN34, 1339-35ZN2ZN35, 1339-35ZN32ZN33



Abbildung: 1340-134ZN37ZN35, 1340-134ZN2ZN35, 1340-134ZN1ZN34, 1340-134ZN32ZN33



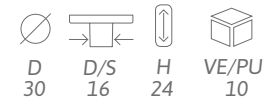

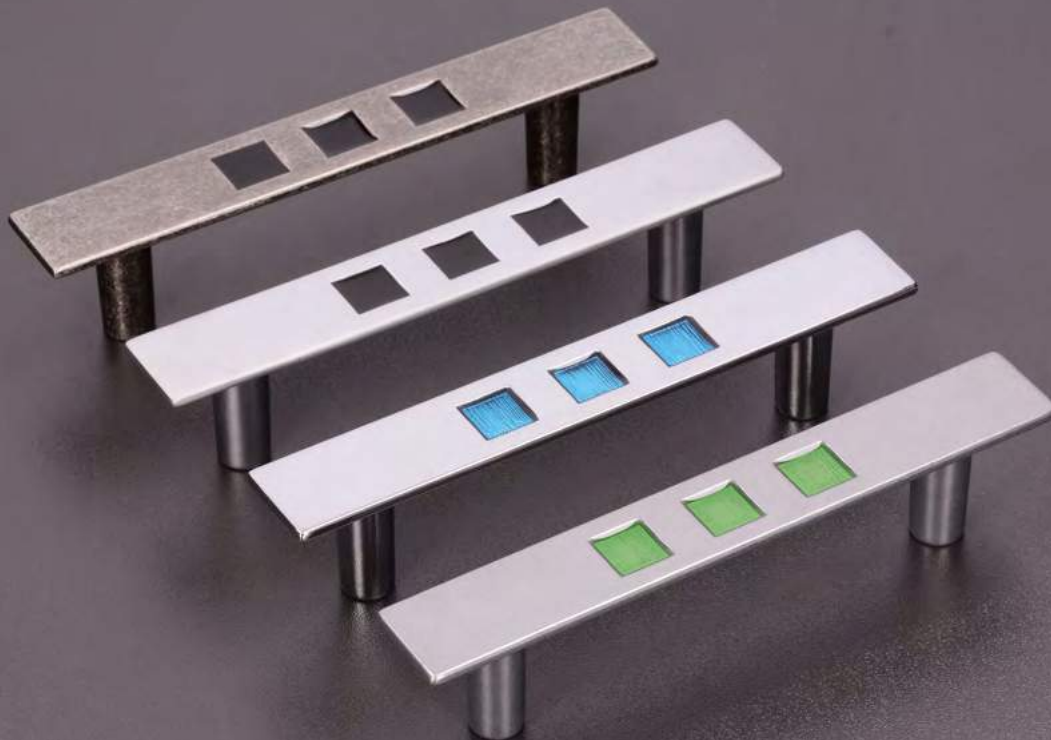

Abbildung: 1313-162ZN1, 1313-130ZN1, 1314-20ZN1, 1313-162ZN21, 1313-130ZN21, 1314-20ZN21



Abbildung: 1309-154ZN2, 1309-116ZN2, 1310-27ZN2, 1309-154ZN21, 1309-116ZN21, 1310-27ZN21

1304



Stahl / steel

Bestellnummer | Order no.  
 1304-104PB12  
 1304-104PB20  
 1304-104ZN9  
 1304-104ZN10  
 1304-136PB12  
 1304-136ZN9  
 1304-136ZN10



L	B/W	H	LA/CC	VE/PU
104	19	38	96	10
136	19	38	128	10

Passend zu 1420 Seite 313, 1421 Seite 312  
 matching 1420 page 313, 1421 page 312

1303



Stahl / steel

Bestellnummer | Order no.  
 1303-34PB12  
 1303-34ZN9  
 1303-34ZN10  
 1303-40PB12  
 1303-40ZN9  
 1303-40ZN10



D	D/S	H	VE/PU
34	14	53	10
40	14	57	10

Passend zu 1420 Seite 313, 1421 Seite 312  
 matching 1420 page 313, 1421 page 312

1268



Stahl / steel

Bestellnummer | Order no.  
 1268-51PB12  
 1268-51ZN9  
 1268-51ZN10  
 1268-62PB12  
 1268-62PB20  
 1268-62ZN9  
 1268-62ZN10  
 1268-74PB12  
 1268-74ZN9  
 1268-74ZN10



L	B/W	H	D/S	VE/PU
51	20	29	12	10
62	22	32	12	10
74	27	35	12	10

Passend zu 1420 Seite 313, 1421 Seite 312  
 matching 1420 page 313, 1421 page 312

1267



Stahl - Druckguss / steel - die cast

Bestellnummer | Order no.  
 1267-115PB12  
 1267-115ZN9  
 1267-115ZN10  
 1267-147PB12  
 1267-147ZN9  
 1267-147ZN10



L	B/W	H	LA/CC	VE/PU
115	40	23	96	10
149	50	30	128	10

Passend zu 1420 Seite 313, 1421 Seite 312  
 matching 1420 page 313, 1421 page 312

1253



Druckguss / die cast

Bestellnummer | Order no.  
 1253-180PB21  
 1253-180ZN1  
 1253-180ZN4  
 1253-180ZN5  
 1253-180ZN21



L	B/W	H	LA/CC	VE/PU
179	18	28	128	10

1245



Druckguss / die cast

Bestellnummer | Order no.  
1245-90ZN1



ZN1

L 90	B/W 10	H 29	LA/CC 64	VE/PU 10

1238



Aluminium / aluminium

Bestellnummer | Order no.  
1238-200AL1  
1238-328AL1



AL1

L 200 328	B/W 20 20	H 35 35	LA/CC 192 320	VE/PU 10 10



Abbildung: 1304-136ZN9

1235



Druckguss / die cast

Passend zu 1207 Seite 147, 1230, 1232 Seite 318  
matching 1207 page 147, 1230, 1232 page 318

Bestellnummer | Order no.  
1235-106ZN29  
1235-126ZN29



ZN29

L	B/W	H	LA/CC	VE/PU
107	21	27	64	10
126	21	32	96	10

1228



Druckguss / die cast

Passend zu 1207 Seite 147, 1230, 1232 Seite 318  
matching 1207 page 147, 1230, 1232 page 318

Bestellnummer | Order no.  
1228-112ZN29



ZN29

L	B/W	H	LA/CC	VE/PU
110	30	25	64	10

1227



Druckguss / die cast

Passend zu 1207 Seite 147, 1230, 1232 Seite 318  
matching 1207 page 147, 1230, 1232 page 318

Bestellnummer | Order no.  
1227-116ZN29



ZN29

L	B/W	H	LA/CC	VE/PU
116	59	21	96	10

1225



Druckguss / die cast

Passend zu 1207 Seite 147, 1230, 1232 Seite 318  
matching 1207 page 147, 1230, 1232 page 318

Bestellnummer | Order no.  
1225-107ZN10  
1225-107ZN29  
1225-127ZN29



ZN10



ZN29

L	B/W	H	LA/CC	VE/PU
106	21	25	64	10
126	21	31	96	10

1223



Druckguss / die cast

Passend zu 1207 Seite 147, 1230, 1232 Seite 318  
matching 1207 page 147, 1230, 1232 page 318

Bestellnummer | Order no.  
1223-66ZN29



ZN29

L	B/W	H	D/S	VE/PU
66	34	32	10	10

LOCHABSTAND | CENTER TO CENTER

LÄNGE | LENGTH

VERPACKUNGSEINHEIT | PACKING UNIT

BREITE | WIDTH

DURCHMESSER | DIAMETER

HÖHE | HEIGHT



1213



Druckguss / die cast

Passend 1217 Seite 319, 1218, 1220, 1241 Seite 318  
matching 1217 page 319, 1218, 1220, 1241 page 318

Bestellnummer | Order no.  
1213-112ZN29



ZN29

L	B/W	H	LA/CC	VE/PU
111	31	26	64	10

1211



Druckguss / die cast

Passend 1217 Seite 319, 1218, 1220, 1241 Seite 318  
matching 1217 page 319, 1218, 1220, 1241 page 318

Bestellnummer | Order no.  
1211-116ZN29



ZN29

L	B/W	H	LA/CC	VE/PU
116	61	21	96	10

1210



Druckguss / die cast

Passend 1217 Seite 319, 1218, 1220, 1241 Seite 318  
matching 1217 page 319, 1218, 1220, 1241 page 318

Bestellnummer | Order no.  
1210-106ZN29  
1210-126ZN29



ZN29

L	B/W	H	LA/CC	VE/PU
105 125	21 20	27 31	64 96	10 10

1315



Druckguss / die cast

Passend 1217 Seite 319, 1218, 1220, 1241 Seite 318  
matching 1217 page 319, 1218, 1220, 1241 page 318

Bestellnummer | Order no.  
1315-22ZN10  
1315-22ZN29



ZN10



ZN29

D	D/S	H	VE/PU
22	7	16	10

1209



Druckguss / die cast

Passend 1217 Seite 319, 1218, 1220, 1241 Seite 318  
matching 1217 page 319, 1218, 1220, 1241 page 318

Bestellnummer | Order no.  
1209-30ZN29  
1209-40ZN29



ZN29

D	D/S	H	VE/PU
30 40	10 10	29 33	10 10

1208



Druckguss / die cast

Passend 1217 Seite 319, 1218, 1220, 1241 Seite 318  
matching 1217 page 319, 1218, 1220, 1241 page 318



ZN29

Bestellnummer | Order no.  
1208-65ZN29

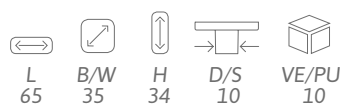

1207



Druckguss / die cast

Passend zu 1223, 1225, 1227, 1228, 1235 Seite 144, 1230, 1232 Seite 318  
matching 1223, 1225, 1227, 1228, 1235 page 144, 1230, 1232 page 318



ZN29

Bestellnummer | Order no.  
1207-34ZN29  
1207-41ZN29

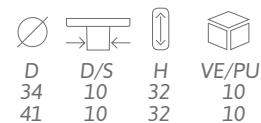

1198



Druckguss / die cast



ZN8



ZN10

Bestellnummer | Order no.  
1198-147ZN8  
1198-147ZN10



Abbildung: 1210-126ZN29, 1209-40ZN29

1188

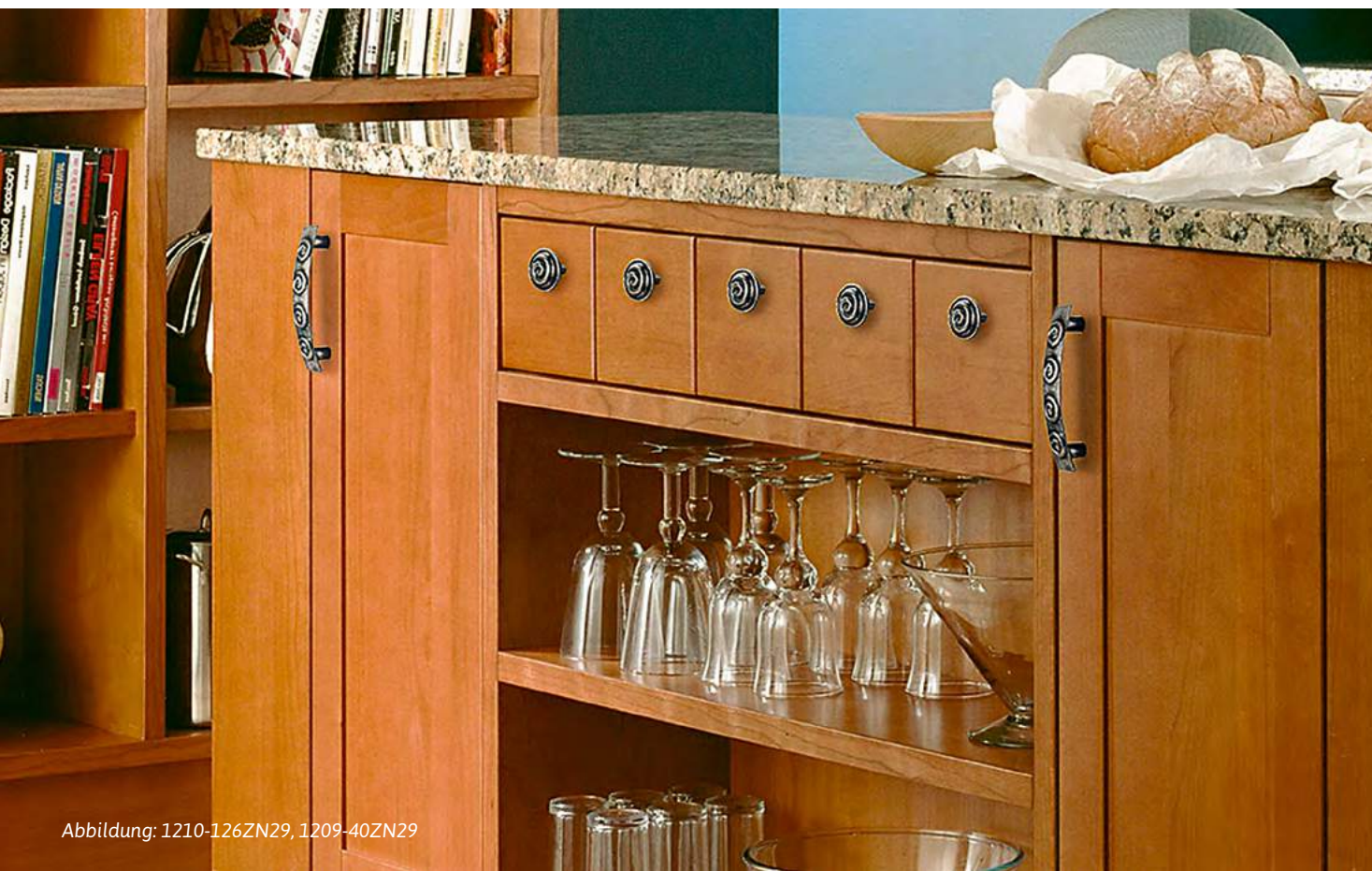

Bestellnummer | Order no.  
1188-161ZN29

Druckguss / die cast

Passend zu 1277 Seite 316, S367 Seite 281, SP36 Seite 270  
matching 1277 page 316, S367 page 281, SP36 Seite 270



ZN29



1185



Bestellnummer | Order no.  
1185-161ZN29

Druckguss / die cast

Passend zu 1265 Seite 317  
matching 1265 page 317



ZN29

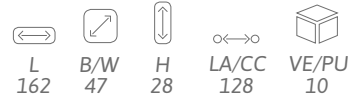

1195



Bestellnummer | Order no.  
1195-22ZN10  
1195-22ZN29

Druckguss / die cast

Passend zu 1277 Seite 316, S367 Seite 281, SP36 Seite 270  
matching 1277 page 316, S367 page 281, SP36 Seite 270



ZN10



ZN29

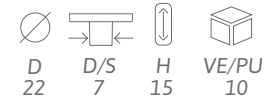

1183



Bestellnummer | Order no.  
1183-35ZN29

Druckguss / die cast

Passend zu 1277 Seite 316, S367 Seite 281, SP36 Seite 270  
matching 1277 page 316, S367 page 281, SP36 Seite 270



ZN29

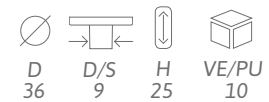

1180



Bestellnummer | Order no.  
1180-34ZN29

Druckguss / die cast

Passend zu 1277 Seite 316, S367 Seite 281, SP36 Seite 270  
matching 1277 page 316, S367 page 281, SP36 Seite 270



ZN29

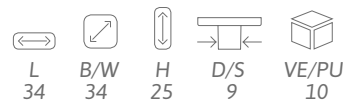



1082



Druckguss / die cast

Passend zu 1265 Seite 317  
matching 1265 page 317



ZN29

Bestellnummer | Order no.  
1082-47ZN29

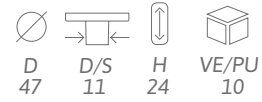

1075



Druckguss / die cast

Passend zu 1277 Seite 316, S367 Seite 281, SP36 Seite 270  
matching 1277 page 316, S367 page 281, SP36 Seite 270



ZN29

Bestellnummer | Order no.  
1075-52ZN29

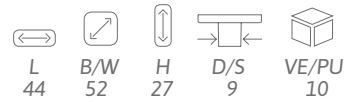

1072



Druckguss / die cast

Passend zu 1277 Seite 316, S367 Seite 281, SP36 Seite 270  
matching 1277 page 316, S367 page 281, SP36 Seite 270



ZN29

Bestellnummer | Order no.  
1072-47ZN29



Abbildung: 1075-52ZN29

1140

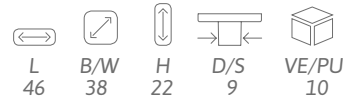

Stahl / steel

Bestellnummer | Order no.  
 1140-90PB8  
 1140-90ZN3  
 1140-116PB1  
 1140-116PB8  
 1140-116ZN3  
 1140-162PB8  
 1140-162ZN3  
 1140-200PB8  
 1140-200ZN3

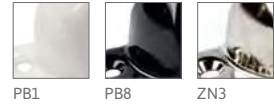

PB1

PB8

ZN3

L	B/W	H	LA/CC	VE/PU
90	29	30	74x13	10
116	29	32	99x13	10
162	37	41	140x19	10
200	37	42	163x19	10

1139



Aluminium / aluminium

Bestellnummer | Order no.  
 1139-60AL1  
 1139-60AL26  
 1139-90AL1  
 1139-90AL26  
 1139-120AL1  
 1139-120AL26



AL1

AL26

L	B/W	H	LA/CC	VE/PU
60	20	27	50	10
90	25	27	80	10
120	27	27	110	10

1126



Druckguss / die cast

Bestellnummer | Order no.  
 1126-67ZN1  
 1126-67ZN2  
 1126-67ZN5



ZN1

ZN2

ZN5

D	D/S	H	VE/PU
67	12	31	10

1117



Druckguss / die cast

Bestellnummer | Order no.  
 1117-125ZN1  
 1117-125ZN2



ZN1

ZN2

L	B/W	H	LA/CC	VE/PU
125	39	29	32	10

1095



Druckguss / die cast

Bestellnummer | Order no.  
 1095-90ZN1  
 1095-90ZN2



ZN1

ZN2

L	B/W	H	LA/CC	VE/PU
90	78	27	32	10



METALL metal

Abbildung: 1126-67ZN2

1059



Druckguss / die cast

Bestellnummer | Order no.  
1059-30ZN10  
1059-30ZN24  
1059-30ZN28



ZN10 ZN24 ZN28

D 32  
 D/S 9  
 H 20  
 VE/PU 10

1058



Druckguss / die cast

Bestellnummer | Order no.  
1058-40ZN10  
1058-40ZN24  
1058-40ZN28



ZN10 ZN24 ZN28

L 42  
 B/W 39  
 H 21  
 D/S 9  
 VE/PU 10

1057

Linksausführung / left finish



Druckguss / die cast

Bestellnummer | Order no.  
1057-52ZN10



ZN10

L 49  
 B/W 30  
 H 21  
 D/S 9  
 VE/PU 10

1056

Rechtsausführung / right finish



Druckguss / die cast

Bestellnummer | Order no.  
1056-52ZN10



ZN10

L 50  
 B/W 31  
 H 23  
 D/S 9  
 VE/PU 10

1053



Druckguss / die cast

Bestellnummer | Order no.  
1053-113ZN24  
1053-113ZN28  
1053-140ZN10  
1053-140ZN24  
1053-140ZN28



ZN10 ZN24 ZN28

L 112  
 B/W 15  
 H 22  
 LA/CC 64  
 VE/PU 10  
 139  
 19  
 23  
 96  
 10

1052



Druckguss / die cast

Bestellnummer | Order no.  
 1052-108ZN10  
 1052-108ZN28  
 1052-126ZN10  
 1052-126ZN24  
 1052-126ZN28



ZN10	ZN24	ZN28		
			↔	↗
L	B/W	H	↔↔	☐
108	28	23	LA/CC	VE/PU
125	30	25	64	10
			96	10

1051



Druckguss / die cast

Bestellnummer | Order no.  
 1051-106ZN10  
 1051-106ZN28  
 1051-128ZN10  
 1051-128ZN24  
 1051-128ZN28



ZN10	ZN24	ZN28		
			↔	↗
L	B/W	H	↔↔	☐
106	14	22	LA/CC	VE/PU
128	19	26	64	10
			96	10



Abbildung: 1058-40ZN10

1049



Druckguss / die cast

Bestellnummer | Order no.  
1049-48ZN10  
1049-48ZN28

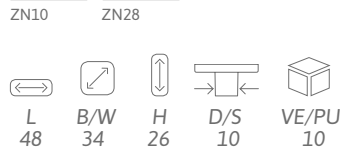

1048



Druckguss / die cast

Bestellnummer | Order no.  
1048-44ZN10  
1048-44ZN24  
1048-44ZN28

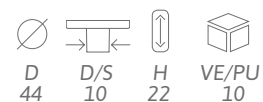

Passend zu 1115, 1116 Seite 322  
matching 1115, 1116 page 322

1047



Druckguss / die cast

Bestellnummer | Order no.  
1047-86ZN24

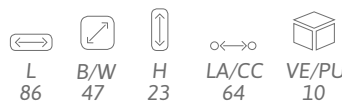

1046



Druckguss / die cast

Bestellnummer | Order no.  
1046-95ZN24



1045



Druckguss / die cast

Bestellnummer | Order no.  
1045-50ZN10  
1045-50ZN24  
1045-50ZN28

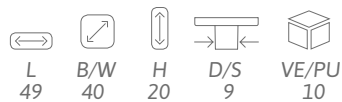

1044



Druckguss / die cast

Bestellnummer | Order no.  
1044-42ZN10  
1044-42ZN24  
1044-42ZN28



ZN10

ZN24

ZN28



L  
40



B/W  
38



H  
19



D/S  
9



VE/PU  
10



Abbildung: 1048-44ZN10

1042



Druckguss / die cast

Bestellnummer | Order no.  
 1042-115PB12  
 1042-115PB21  
 1042-115ZN1  
 1042-115ZN21  
 1042-160PB12  
 1042-160PB21  
 1042-160ZN1  
 1042-160ZN21  
 1042-197PB21  
 1042-197ZN1  
 1042-197ZN21

PB12	PB21	ZN1	ZN21
L	B/W	H	LA/CC
113	11	27	96
163	10	28	128
197	12	32	160
VE/PU	10		

1029



Druckguss / die cast

Bestellnummer | Order no.  
 1029-147ZN1  
 1029-147ZN2  
 1029-147ZN4  
 1029-147ZN21

ZN1	ZN2	ZN4	ZN21
L	B/W	H	LA/CC
146	15	30	128
VE/PU	10		

1026



Druckguss / die cast

Bestellnummer | Order no.  
 1026-135ZN1  
 1026-135ZN2  
 1026-135ZN4

ZN1	ZN2	ZN4	
L	B/W	H	
135	14	26	
LA/CC	VE/PU	10	
96			

1022



Druckguss / die cast

Bestellnummer | Order no.  
 1022-156ZN1  
 1022-156ZN4  
 1022-156ZN10  
 1022-156ZN21

ZN1	ZN4	ZN10	ZN21
L	B/W	H	LA/CC
154	11	25	128
VE/PU	10		

1021



Druckguss / die cast

Bestellnummer | Order no.  
 1021-146ZN4  
 1021-146ZN21

ZN4	ZN21
L	B/W
145	11
H	LA/CC
22	96
VE/PU	VE/PU
10	10



1013



Bestellnummer | Order no.  
 1013-147ZN1  
 1013-147ZN21  
 1013-215ZN1  
 1013-215ZN21



L	B/W	H	LA/CC	VE/PU
147	19	34	128	10
214	23	37	192	10

Druckguss / die cast

1003



Bestellnummer | Order no.  
 1003-79ZN21



L	B/W	H	LA/CC	VE/PU
78	28	23	64	10

Druckguss / die cast



1001



Druckguss / die cast

Bestellnummer | Order no.  
 1001-131ZN1  
 1001-131ZN2  
 1001-131ZN4  
 1001-131ZN21

ZN1	ZN2	ZN4	ZN21
L	B/W	H	LA/CC
128	14	25	96
			VE/PU
			10

1000



Druckguss / die cast

Bestellnummer | Order no.  
 1000-133ZN2  
 1000-133ZN4  
 1000-133ZN21

ZN2	ZN4	ZN21		
L	B/W	H	LA/CC	VE/PU
133	20	24	96	10

1034

Linksausführung / left finish



Druckguss / die cast

Bestellnummer | Order no.  
 1034-107ZN1  
 1034-107ZN4  
 1034-107ZN21

ZN1	ZN4	ZN21		
L	B/W	H	LA/CC	VE/PU
107	53	27	96	10

940



Druckguss / die cast

Bestellnummer | Order no.  
 940-107ZN1  
 940-107ZN2  
 940-107ZN4  
 940-107ZN21  
 940-141PB12  
 940-141ZN1  
 940-141ZN2  
 940-141ZN4  
 940-141ZN5  
 940-141ZN10  
 940-141ZN21

PB12	ZN1	ZN2	ZN4	
ZN5	ZN10	ZN21		
L	B/W	H	LA/CC	VE/PU
107	19	26	96	10
141	25	26	128	10

939



Druckguss - Kunststoff / die cast - plastic

Bestellnummer | Order no.  
 939-34ZN2T7  
 939-34ZN4DB3  
 939-40ZN1MT1  
 939-40ZN4DB3

ZN1MT1	ZN2T7	ZN4DB3	
D	D/S	H	VE/PU
34	12	24	10
40	15	27	10

935

In Italien nicht lieferbar / Not available in Italy



Bestellnummer | Order no.  
935-169ZN2T7



ZN2T7



Druckguss - Kunststoff / die cast - plastic

933



Druckguss / die cast

Bestellnummer | Order no.  
933-15PB12  
933-15ZN1  
933-15ZN2  
933-15ZN4  
933-15ZN10  
933-15ZN21

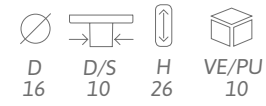

932



Druckguss / die cast

Bestellnummer | Order no.  
932-16PB12  
932-16ZN1  
932-16ZN2  
932-16ZN4  
932-16ZN5  
932-16ZN10  
932-16ZN21



Abbildung: 932-16ZN1

930

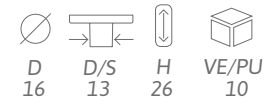

Stahl / steel

Bestellnummer | Order no.

- 930-114ZN1
- 930-114ZN2
- 930-114ZN4
- 930-114ZN5
- 930-114ZN21
- 930-149ZN1
- 930-149ZN2
- 930-149ZN4
- 930-149ZN5
- 930-149ZN21
- 930-191ZN1
- 930-191ZN2
- 930-191ZN4
- 930-191ZN5
- 930-191ZN21
- 930-223ZN1
- 930-223ZN2
- 930-223ZN4
- 930-223ZN5
- 930-223ZN10
- 930-223ZN21
- 930-268ZN1
- 930-268ZN2
- 930-268ZN5
- 930-268ZN21
- 930-385ZN1
- 930-385ZN2
- 930-385ZN4
- 930-385ZN5
- 930-385ZN21
- 930-114ZN2V3\*
- 930-149ZN2V3\*



L	B/W	H	LA/CC	VE/PU
114	10	31	96	10
148	10	31	128	10
189	10	31	160	10
221	10	30	192	10
267	10	31	224	10
379	10	31	320	10
*114	10	31	96	5
*148	10	31	128	5

\* Bestellnr. für 3 Stück / order no. for 3 pcs.  
VE / MOQ : 5 = 15 Stück / pieces

926



Druckguss / die cast

Bestellnummer | Order no.  
926-107ZN10



ZN10

L	B/W	H	LA/CC	VE/PU
107	49	19	76	10

925



Druckguss / die cast

Bestellnummer | Order no.  
925-75ZN5  
925-75ZN10



ZN5

ZN10

L	B/W	H	LA/CC	VE/PU
74	47	19	64	10

924



Druckguss / die cast

Bestellnummer | Order no.  
924-108ZN5  
924-108ZN10



ZN5

ZN10

L	B/W	H	LA/CC	VE/PU
109	22	23	76	10

923



Druckguss / die cast

Bestellnummer | Order no.  
923-101ZN1  
923-101ZN5



ZN1

ZN5

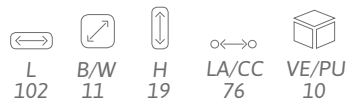

L

102

B/W

11

H

19

LA/CC

76

VE/PU

10

922



Druckguss / die cast

Bestellnummer | Order no.  
922-113ZN5  
922-113ZN10



ZN5

ZN10

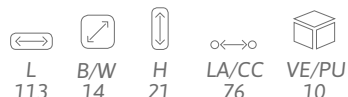

L

113

B/W

14

H

21

LA/CC

76

VE/PU

10

921



Druckguss / die cast

Bestellnummer | Order no.  
921-127ZN1  
921-127ZN5  
921-127ZN10



ZN1

ZN5

ZN10



L

126

B/W

16

H

25

LA/CC

76

VE/PU

10



Abbildung: 924-108ZN10

920



Druckguss / die cast

Bestellnummer | Order no.  
 920-28ZN1  
 920-28ZN2  
 920-28ZN5  
 920-28ZN10

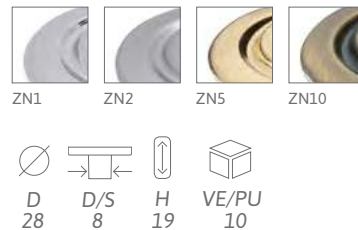

919



Druckguss - Kunststoff / die cast - plastic

Bestellnummer | Order no.  
 919-30ZN1K72  
 919-30ZN5K72

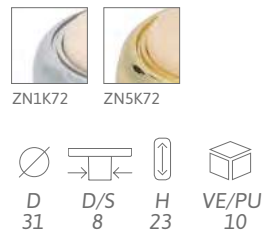

918



Druckguss / die cast

Bestellnummer | Order no.  
 918-38ZN1  
 918-38ZN2  
 918-38ZN5  
 918-38ZN16

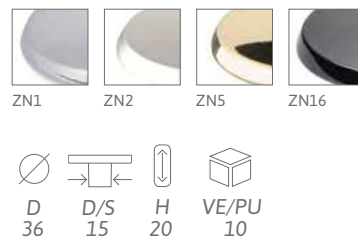

917



Druckguss / die cast

Bestellnummer | Order no.  
 917-105ZN1  
 917-105ZN5  
 917-105ZN16



916



Druckguss / die cast

Bestellnummer | Order no.  
 916-135ZN1  
 916-135ZN5  
 916-135ZN16

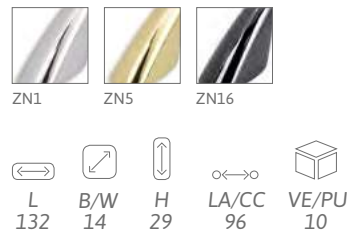

915



Druckguss / die cast

Bestellnummer | Order no.  
915-111ZN1  
915-111ZN5



ZN1

ZN5



L

111

B/W

10

H

21

LA/CC

102

VE/PU

10

914



Druckguss / die cast

Bestellnummer | Order no.  
914-102ZN1  
914-102ZN2  
914-102ZN5  
914-102ZN16



ZN1

ZN2

ZN5

ZN16



L

104

B/W

8

H

28

LA/CC

96

VE/PU

10

913



Druckguss / die cast

Bestellnummer | Order no.  
913-32ZN1  
913-32ZN2  
913-32ZN5



ZN1

ZN2

ZN5

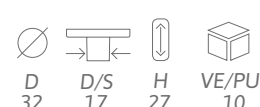

D

32

D/S

17

H

27

VE/PU

10



Abbildung: 920-28ZN1

912



Druckguss / die cast

Bestellnummer | Order no.  
912-73ZN1  
912-73ZN2  
912-73ZN5

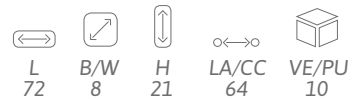

911



Druckguss / die cast

Bestellnummer | Order no.  
911-72ZN1  
911-72ZN2  
911-72ZN5  
911-72ZN16

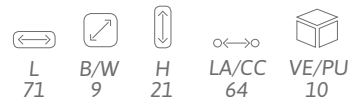

910



Druckguss / die cast

Bestellnummer | Order no.  
910-104ZN1  
910-104ZN2

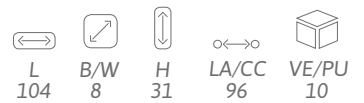

909



Druckguss / die cast

Bestellnummer | Order no.  
909-107ZN1  
909-107ZN2  
909-107ZN5

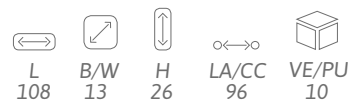

908



Druckguss / die cast

Bestellnummer | Order no.  
908-110ZN1  
908-110ZN2  
908-110ZN5  
908-110ZN16

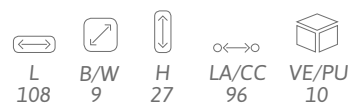



885



Stahl / steel

Bestellnummer | Order no.

885-178ZN1  
885-178ZN4  
885-178ZN21

885-208PB21  
885-208ZN1  
885-208ZN4  
885-208ZN21

885-240PB21  
885-240ZN1  
885-240ZN4  
885-240ZN21

885-272ZN1  
885-272ZN4  
885-272ZN21

885-320ZN1  
885-320ZN4  
885-320ZN21

885-368ZN1  
885-368ZN4  
885-368ZN21

885-416ZN1  
885-416ZN4  
885-416ZN21

885-512ZN1  
885-512ZN4  
885-512ZN21

885-559ZN1  
885-559ZN4  
885-559ZN21

885-635ZN1  
885-635ZN4  
885-635ZN21

885-688ZN1  
885-688ZN4  
885-688ZN21

885-816ZN1  
885-816ZN4  
885-816ZN21

885-863ZN1  
885-863ZN4  
885-863ZN21

885-1449ZN1  
885-1449ZN4  
885-1449ZN21

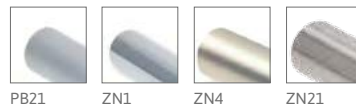

PB21

ZN1

ZN4

ZN21

L	B/W	H	LA/CC	VE/PU
178	12	32	96	5
208	12	32	128	5
240	12	32	160	5
272	12	32	192	5
320	12	32	240	5
368	12	32	288	5
416	12	32	336	5
512	12	32	432	5
559	12	32	480	5
635	12	32	552	5
688	12	32	608	5
816	12	32	736	5
863	12	32	784	5
1449	12	32	2x684	5



Abbildung: 885-208PB21

878



Druckguss / die cast

Passend zu 1098 Seite 322  
matching 1098 page 322

Bestellnummer | Order no.  
878-128ZN1  
878-128ZN2  
878-128ZN4  
878-128ZN5  
878-128ZN21  
878-160ZN1  
878-160ZN2  
878-160ZN4  
878-160ZN5  
878-160ZN21  
878-190ZN1  
878-190ZN2  
878-190ZN4

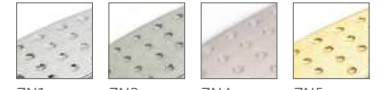

ZN1

ZN2

ZN4

ZN5



ZN21

L	B/W	H	LA/CC	VE/PU
125	17	28	96	10
159	18	30	128	10
190	18	32	160	10

873



Druckguss / die cast

Passend zu 1098 Seite 322  
matching 1098 page 322

Bestellnummer | Order no.  
873-28ZN1  
873-28ZN2  
873-28ZN4  
873-28ZN10  
873-28ZN21  
873-34ZN1  
873-34ZN2  
873-34ZN4  
873-34ZN21



ZN1

ZN2

ZN4

ZN10



ZN21

D	D/S	H	VE/PU
28	12	24	10
33	14	27	10

872



Druckguss / die cast

Bestellnummer | Order no.  
872-24ZN1  
872-24ZN2  
872-24ZN4



ZN1

ZN2

ZN4

D	D/S	H	VE/PU
24	12	27	10

871



Druckguss / die cast

Bestellnummer | Order no.  
871-37ZN1  
871-37ZN2  
871-37ZN4  
871-37ZN5  
871-37ZN10  
871-37ZN21



ZN1

ZN2

ZN4

ZN5



ZN10

ZN21

L	B/W	H	VE/PU
38	27	26	10

869



Druckguss / die cast

Bestellnummer | Order no.  
869-185ZN2  
869-185ZN4  
869-185ZN21



ZN2

ZN4

ZN21

L	B/W	H	LA/CC	VE/PU
185	25	30	160	10

820



Bestellnummer | Order no.  
820-85ZN1  
820-85ZN4

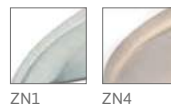

ZN1

ZN4



L  
84

B/W  
25

H  
20

LA/CC  
64

VE/PU  
10

Druckguss / die cast

819



Bestellnummer | Order no.  
819-16PB1  
819-16ZN1  
819-16ZN4  
819-16ZN5  
819-16ZN15



PB1

ZN1

ZN4

ZN5



ZN15

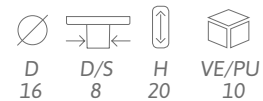

D  
16

D/S  
8

H  
20

VE/PU  
10

Druckguss / die cast



Abbildung: 819-16ZN4

818



Druckguss / die cast

Bestellnummer | Order no.  
818-28ZN1  
818-28ZN4  
818-28ZN5



ZN1 ZN4 ZN5

L	B/W	H	VE/PU
28	14	21	10

816



Druckguss / die cast

Bestellnummer | Order no.  
816-40ZN1  
816-40ZN4



ZN1 ZN4

L	B/W	H	LA/CC	VE/PU
40	22	18	32	10

815



Druckguss / die cast

Bestellnummer | Order no.  
815-95ZN1  
815-95ZN4  
815-127ZN1  
815-127ZN4



ZN1 ZN4

L	B/W	H	LA/CC	VE/PU
96 127	20 21	24 23	64 96	10 10

812



Druckguss / die cast

Bestellnummer | Order no.  
812-86ZN10  
812-120ZN10



ZN10

L	B/W	H	LA/CC	VE/PU
86 121	22 25	24 25	64 96	10 10

811



Druckguss / die cast

Bestellnummer | Order no.  
811-93ZN1  
811-93ZN4  
811-93ZN5  
811-93ZN19



ZN1 ZN4 ZN5 ZN19

L	B/W	H	LA/CC	VE/PU
93	27	20	64	10



METALL metal

Abbildung: 811-93ZN1

809



Druckguss / die cast

Bestellnummer | Order no.  
 809-130ZN1  
 809-130ZN2  
 809-130ZN4  
 809-130ZN10  
 809-130ZN21  
 809-165PB12  
 809-165ZN1  
 809-165ZN2  
 809-165ZN4  
 809-165ZN5  
 809-165ZN21







 PB12	 ZN1	 ZN2	 ZN4
 ZN5	 ZN10	 ZN21	
 L 130 165	 B/W 12 13	 H 29 30	 LA/CC 96 128
		 VE/PU 10 10	

806



Druckguss - Holz / die cast - wood

Bestellnummer | Order no.  
 806-126ZN1HZ18









 ZN1HZ18				
 L 126	 B/W 25	 H 29	 LA/CC 96	 VE/PU 10

805



Druckguss / die cast

Bestellnummer | Order no.  
 805-126PB12  
 805-126ZN1  
 805-126ZN4  
 805-126ZN5







 PB12	 ZN1	 ZN4	 ZN5
 L 126	 B/W 8	 H 29	 LA/CC 96
		 VE/PU 10	

795



Messing / solid brass

Bestellnummer | Order no.  
 795-17MS1  
 795-17MS4  
 795-17MS8



 MS1	 MS4	 MS8
 D 17	 D/S 14	 H 26
		 VE/PU 10

769



Druckguss / die cast

Bestellnummer | Order no.  
 769-115ZN4  
 769-146ZN4  
 769-146ZN5

 ZN4	 ZN5			
 L 117 146	 B/W 9 9	 H 26 29	 LA/CC 96 128	 VE/PU 10 10

764



Druckguss / die cast

Bestellnummer | Order no.  
764-74ZN4  
764-74ZN5



ZN4

ZN5



753



Druckguss / die cast

Bestellnummer | Order no.  
753-60ZN21



ZN21

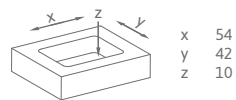
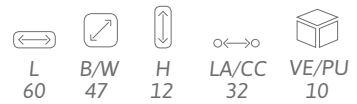

x 54  
y 42  
z 10



Abbildung: 805-126ZN1

742



Stahl / steel

Bestellnummer | Order no.  
742-124FE2  
742-152FE2



FE2

L	B/W	H	LA/CC	VE/PU
127	32	27	108x15	10
154	36	27	134x19	10

657



Stahl / steel

Bestellnummer | Order no.  
657-110ZN1  
657-110ZN4  
657-154PB7  
657-154ZN1  
657-154ZN4  
657-154ZN5



PB7

ZN1

ZN4

ZN5

L	B/W	H	LA/CC	VE/PU
108	8	24	96	10
153	10	28	128	10

646



Druckguss / die cast

Bestellnummer | Order no.  
646-18ZN1  
646-18ZN5  
646-18ZN21

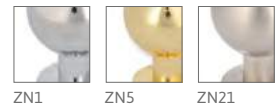

ZN1

ZN5

ZN21

D	D/S	H	VE/PU
18	15	27	10

641



Messing / solid brass

Bestellnummer | Order no.  
641-20MS1



MS1

D	D/S	H	VE/PU
20	20	22	10

640



Messing / solid brass

Bestellnummer | Order no.  
640-34MS1



MS1

D	D/S	H	VE/PU
33	24	26	10



639



Messing / solid brass

Bestellnummer | Order no.  
639-34MS1



MS1



D  
33



D/S  
24



H  
26



VE/PU  
10











6300

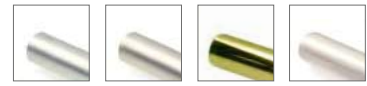

Druckguss / die cast

Bestellnummer | Order no.  
6300-158ZN2  
6300-158ZN4  
6300-158ZN5  
6300-158ZN21



 L 157	 B/W 14	 H 33	 LA/CC 96	 VE/PU 10
---	--	--	--	--

METALL metal



Abbildung: 6211-138ZN1

565



Druckguss / die cast

Bestellnummer | Order no.  
565-30ZN8  
565-30ZN10

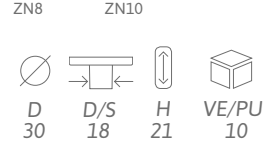
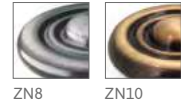

564



Druckguss / die cast

Bestellnummer | Order no.  
564-40ZN8  
564-40ZN10

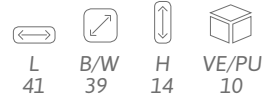

563



Druckguss / die cast

Bestellnummer | Order no.  
563-105ZN8  
563-105ZN10

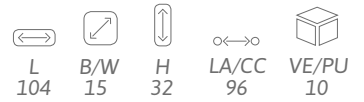

550



Druckguss / die cast

Bestellnummer | Order no.  
550-85ZN1  
550-85ZN4  
550-85ZN5  
550-85ZN10

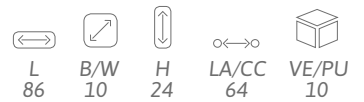

549



Druckguss / die cast

Bestellnummer | Order no.  
549-29ZN1  
549-29ZN5  
549-29ZN10

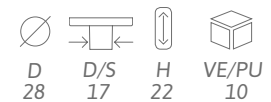

531



Druckguss / die cast

Bestellnummer | Order no.  
531-103ZN10



ZN10



527



Messing / solid brass

Bestellnummer | Order no.  
527-20MS1  
527-20MS3  
527-20MS4  
527-25MS1  
527-25MS4  
527-30MS1



MS1



MS3



MS4

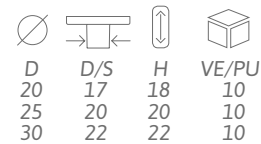

523



Messing / solid brass

Bestellnummer | Order no.  
523-25MS1



MS1



Abbildung: 565-30ZN10



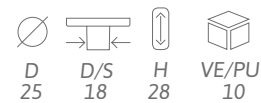

Abbildung: 522-35MS3

481



Druckguss / die cast

Bestellnummer | Order no.  
481-85ZN10



ZN10

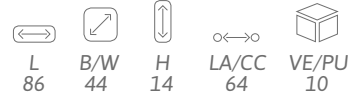

479



Druckguss / die cast

Bestellnummer | Order no.  
479-76ZN5  
479-76ZN10  
479-106ZN5  
479-106ZN10



ZN5



ZN10

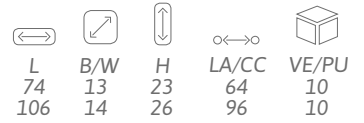

423



Messing / solid brass

Bestellnummer | Order no.  
423-25MS1  
423-25MS2



MS1



MS2

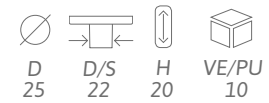

398



Messing / solid brass

Bestellnummer | Order no.  
398-98MS3



MS3

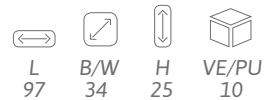

397



Druckguss / die cast

Bestellnummer | Order no.  
397-35MS3



MS3

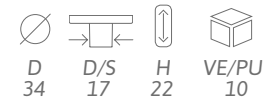



392



Druckguss / die cast

Bestellnummer | Order no.  
392-30ZN4  
392-30ZN10  
392-40ZN4

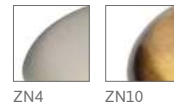





 D	 D/S	 H	 VE/PU
30	9	17	10
40	9	21	10



Abbildung: 398-98MS3

365



Druckguss / die cast

Bestellnummer | Order no.  
365-70ZN8  
365-70ZN10



ZN8

ZN10



L  
70

B/W  
25

H  
3

VE/PU  
10

364



Druckguss / die cast

Bestellnummer | Order no.  
364-78ZN10



ZN10



L  
78

B/W  
38

H  
3

VE/PU  
10

361



Druckguss / die cast

Bestellnummer | Order no.  
361-42ZN8  
361-42ZN10

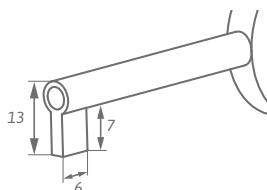

ZN8

ZN10



L  
83

B/W  
6

H  
34

VE/PU  
10

357



Druckguss / die cast

Bestellnummer | Order no.  
357-33ZN8  
357-33ZN10



ZN8

ZN10

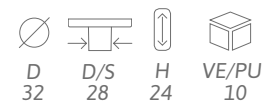

D  
32

D/S  
28

H  
24

VE/PU  
10

356



Druckguss / die cast

Bestellnummer | Order no.  
356-97ZN8  
356-97ZN10



ZN8

ZN10



L  
95

B/W  
32

H  
24

VE/PU  
10



Abbildung: 356-97ZN10, 357-33ZN10

METALL metal

---

# EDELSTAHL

---

Bei Edelstahl handelt es sich um einen metallischen, zeitlosen Werkstoff, der einen besonders hohen Reinheitsgrad aufweist. Edelstahl zeichnet sich unter anderem durch seine Korrosions- und Temperaturbeständigkeit sowie durch seine Langlebigkeit und die vielfältigen Verwendungsmöglichkeiten aus.

Unserem Nachhaltigkeitsansatz entsprechend legen wir darauf Wert, auch bei unseren Edelstahl-Beschlägen die höchstmögliche Haltbarkeit zu garantieren. Daher achten wir bei der Herstellung besonders auf den richtigen Materialmix, eine präzise Verarbeitung und schonende Ressourcennutzung.

Unsere Edelstahl-Beschläge präsentieren dieses edle Material in seiner schönsten Form. Die Griffe sind in runder oder eckiger Ausführung erhältlich und eine Vielzahl von Längen ermöglicht eine Abstimmung auf unterschiedliche Möbelgrößen. Darüber hinaus wird eine reiche Auswahl an Edelstahl-Knöpfen in verschiedenen Formen und Größen geboten. Vollendet wird das Sortiment mit Muschelgriffen, die sich für den flachen Einbau eignen.

Griffe und Knöpfe können individuell kombiniert werden und sorgen so für ein harmonisches Gesamtbild. Die klaren Linien und das reduzierte Design passen hervorragend zu einem modernen Wohnstil. Die Beschläge aus Edelstahl sind für alle Anwendungsbereiche geeignet und mit ihrer zeitlosen Eleganz und ihrer Beständigkeit sind sie die perfekte Ergänzung für stilvolle und langlebige Möbelstücke.

---

# STAINLESS STEEL

---

Stainless steel is a timeless alloy with a particularly high level of purity. It stands out due to its resistance to corrosion and high temperatures as well as its durability and many possible uses.

Our commitment to sustainability means that we can guarantee that our stainless steel fittings have the longest possible service life. During production, we pay particular attention to the correct combination of materials, precise workmanship and careful use of resources.

Our stainless steel fittings reveal the most stunning side of this material. The handles are available in rounded or square designs, while the many different lengths mean that we can provide the perfect size for almost any item of furniture. We also sell a wide range of stainless steel knobs in various shapes and sizes as well as recessed handles suitable for flush-mount installation.

Handles and knobs can be combined on an individual basis to complement an overall style. Their clean lines and minimalist design are ideal for a modern living environment. These stainless steel fittings are suitable for all areas, their timeless elegance and durability making them the perfect addition to stylish and long-lasting items of furniture.

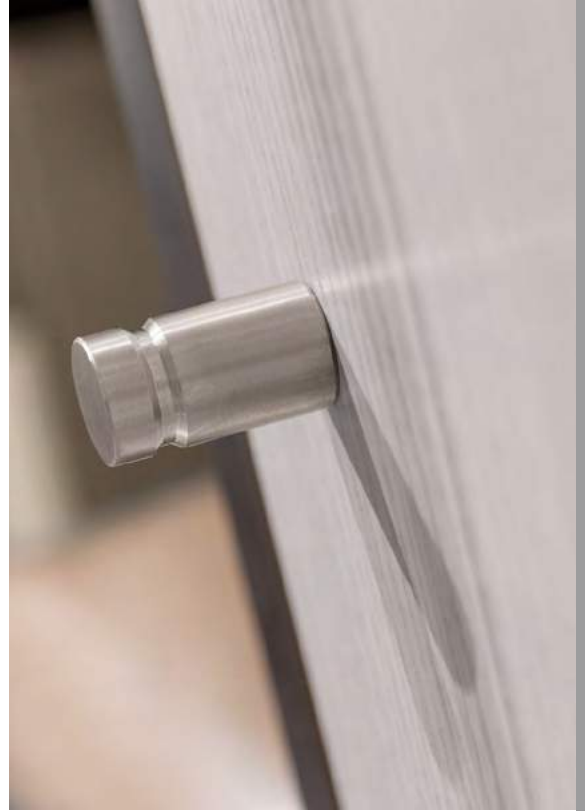

2423H hohl / hollow



Bestellnummer | Order no.  
2423H-106N1  
2423H-138N1  
2423H-170N1

Edelstahl / stainless steel



N1

L	D	H	LA/CC	VE/PU
106	10	32	96	10
138	10	32	128	10
170	10	32	160	10

2419



Bestellnummer | Order no.  
2419-20N1  
2419-25N1

Edelstahl / stainless steel



N1

D	D/S	H	VE/PU
20	10	28	10
25	13	28	10

2387H hohl / hollow



Bestellnummer | Order no.  
2387H-76N1  
2387H-108N1  
2387H-140N1  
2387H-172N1  
2387H-332N1

Edelstahl / stainless steel



N1

L	B/W	H	LA/CC	VE/PU
76	12	35	64	10
108	12	35	96	10
140	12	35	128	10
172	12	35	160	10
332	12	35	320	5

2373



Bestellnummer | Order no.  
2373-32N1  
2373-96N1  
2373-192N1

Edelstahl / stainless steel



N1

L	B/W	H	LA/CC	VE/PU
32	40	20	16	10
96	40	20	64	10
192	40	20	160	10

2372



Bestellnummer | Order no.  
2372-32N1  
2372-96N1  
2372-192N1

Edelstahl / stainless steel



N1

L	B/W	H	LA/CC	VE/PU
32	40	20	16	10
96	40	20	64	10
192	40	20	160	10

↔ LOCHABSTAND | CENTER TO CENTER

↔ LÄNGE | LENGTH

📦 VERPACKUNGSEINHEIT | PACKING UNIT

↔ BREITE | WIDTH

⊘ DURCHMESSER | DIAMETER

📏 HÖHE | HEIGHT





Abbildung: 2387H-76N1, 2387H-108N1, 2387H-140N1, 2387H-172N1, 2423H-170N1, 2423H-138N1, 2423H-106N1





2280

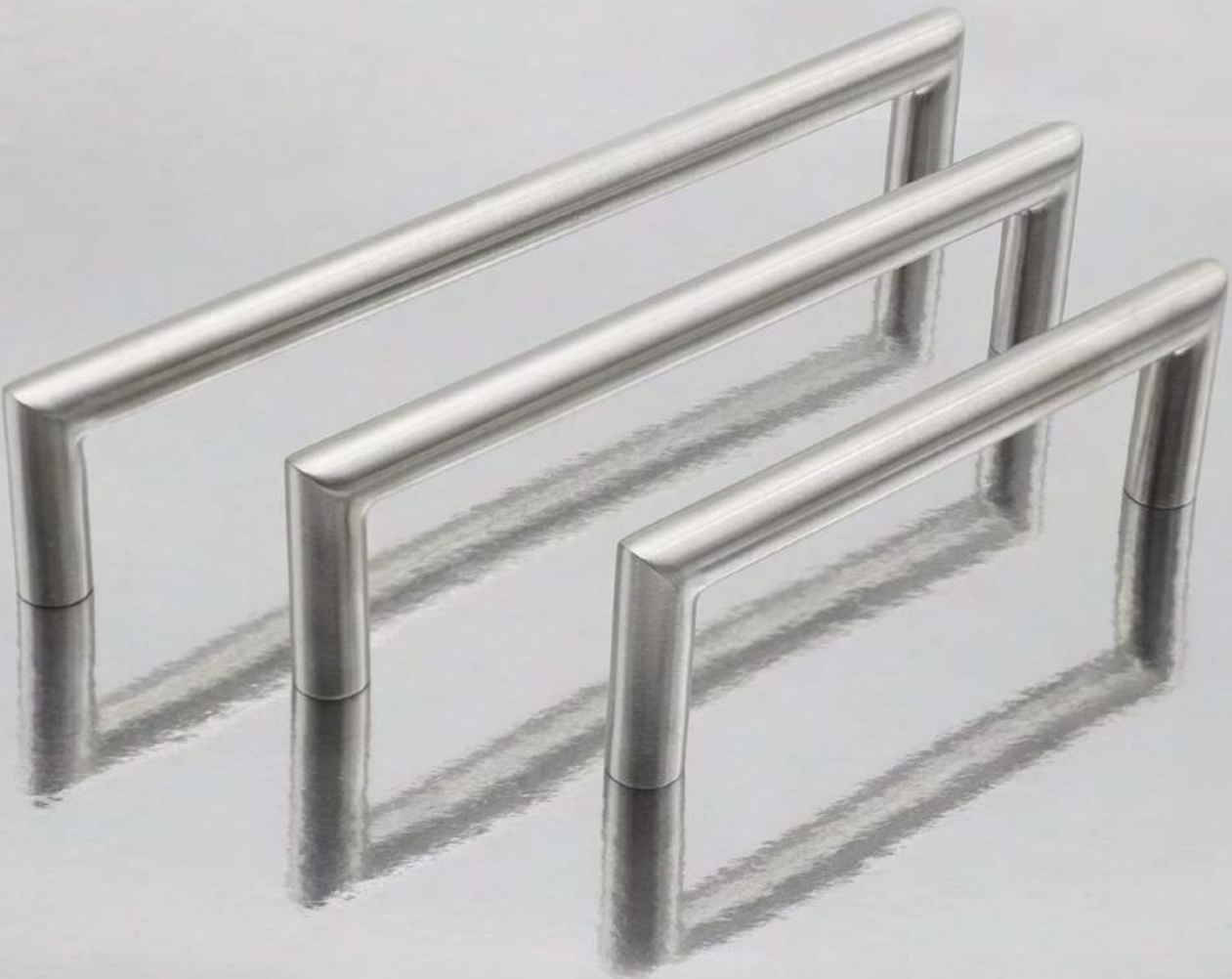
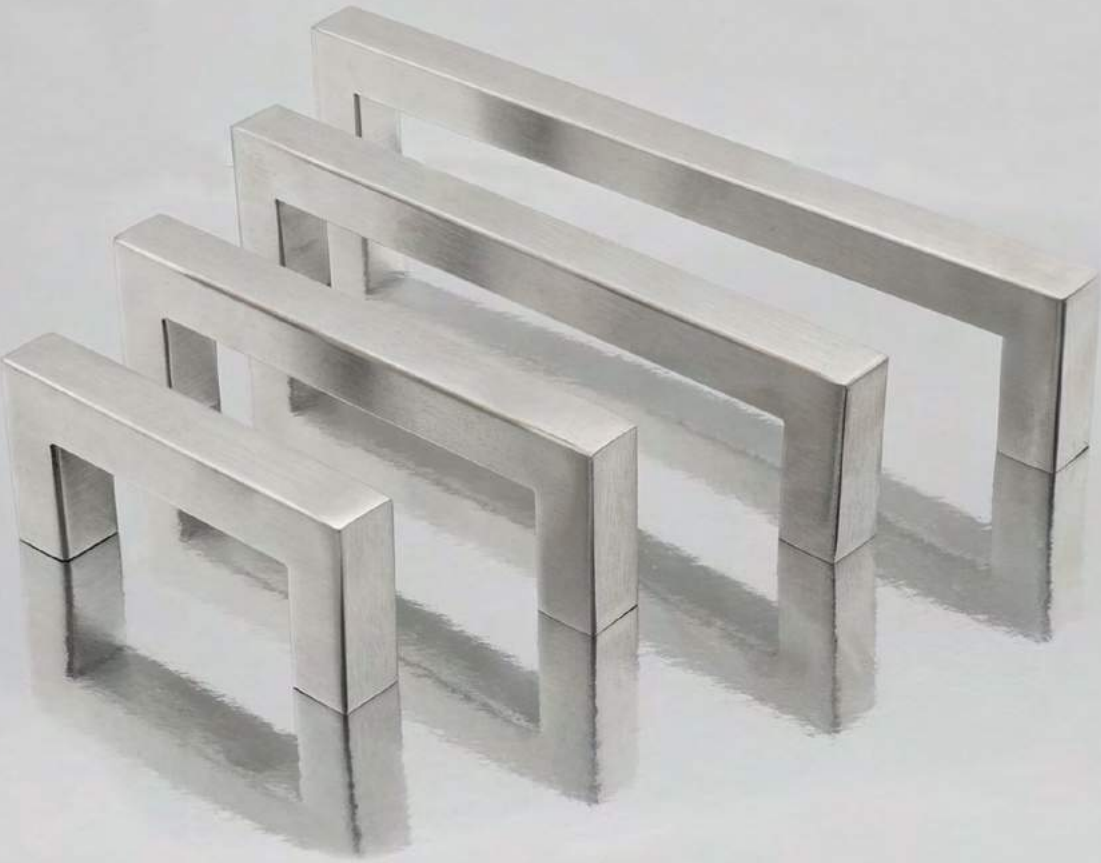

Edelstahl / stainless steel

Bestellnummer | Order no.  
2280-10N1  
2280-14N1



N1

D	D/S	H	VE/PU
10	10	25	10
14	14	25	10

2279



Edelstahl / stainless steel

Bestellnummer | Order no.  
2279-14N1  
2279-18N1  
2279-22N1



N1

D	D/S	H	VE/PU
14	9	15	10
18	13	15	10
22	17	17	10

2277



Edelstahl / stainless steel

Bestellnummer | Order no.  
2277-10N1  
2277-15N1



N1

D	D/S	H	VE/PU
10	10	22	10
15	15	25	10

Passend zu 2301, 2302, 2315, 2316 Seite 334  
matching 2301, 2302, 2315, 2316 page 334

2275



Edelstahl / stainless steel

Bestellnummer | Order no.  
2275-16N1  
2275-20N1  
2275-23N1



N1

D	D/S	H	VE/PU
16	11	19	10
20	14	24	10
23	16	28	10



Abbildung: 2293-180N1

2188H hohl / hollow



Edelstahl / stainless steel

Bestellnummer | Order no.  
 2188H-176N1  
 2188H-208N1  
 2188H-240N1  
 2188H-272N1  
 2188H-304N1



N1

L	D	H	LA/CC	VE/PU
176	12	32	96	10
208	12	32	128	10
240	12	32	160	10
272	12	32	192	10
304	12	32	224	10

1739 hohl / hollow



Edelstahl / stainless steel

Bestellnummer | Order no.  
 1739-170N1  
 1739-202N1  
 1739-234N1  
 1739-330N1  
 1739-490N1



N1

L	B/W	H	LA/CC	VE/PU
170	40	40	160	5
202	40	40	192	5
234	40	40	224	5
330	40	40	320	5
490	40	40	480	5

1660



Edelstahl / stainless steel

Bestellnummer | Order no.  
 1660-132N1  
 1660-166N1  
 1660-200N1



N1

L	D	H	LA/CC	VE/PU
132	10	26	96	10
166	10	26	128	10
200	10	26	160	10

1659



Edelstahl / stainless steel

Bestellnummer | Order no.  
 1659-13N1  
 1659-18N1



N1

D	D/S	H	VE/PU
13	13	22	10
18	18	27	10

1628



Edelstahl / stainless steel

Bestellnummer | Order no.  
 1628-25N1



N1

D	D/S	H	VE/PU
25	25	33	10



EDELSTAHL stainless steel

Abbildung: 1660-166N1, 1659-18N1

1613



Edelstahl / stainless steel

Bestellnummer | Order no.  
1613-87N1  
1613-119N1  
1613-151N1



N1

L	B/W	H	LA/CC	VE/PU
87	12	32	64	10
119	12	32	96	10
151	12	32	128	10

1612



Edelstahl / stainless steel

Bestellnummer | Order no.  
1612-10N1  
1612-15N1  
1612-20N1  
1612-25N1  
1612-30N1



N1

D	D/S	H	VE/PU
10	10	24	10
15	15	26	10
20	20	28	10
25	25	30	10
30	30	33	10

1611



Edelstahl / stainless steel

Bestellnummer | Order no.  
1611-20N1  
1611-25N1  
1611-30N1  
1611-35N1



N1

D	D/S	H	VE/PU
20	13	17	10
25	17	21	10
30	20	25	10
35	24	27	10

1585

hohl / hollow



Edelstahl / stainless steel

Bestellnummer | Order no.  
1585-79N1  
1585-111N1  
1585-143N1  
1585-175N1  
1585-207N1  
1585-335N1



N1

L	B/W	H	LA/CC	VE/PU
79	15	40	64	10
111	15	40	96	10
143	15	40	128	10
175	15	40	160	10
207	15	40	192	10
335	15	40	320	10

1531



Edelstahl - Druckguss / stainless steel - die cast

Bestellnummer | Order no.  
1531-148N1Z21  
1531-180N1Z21  
1531-212N1Z21  
1531-308N1Z21  
1531-372N1Z21  
1531-468N1Z21



N1Z21

L	D	H	LA/CC	VE/PU
148	10	38	128	10
180	10	38	160	10
212	10	38	192	10
308	10	38	288	10
372	10	38	352	10
468	10	38	448	5

↔ LOCHABSTAND | CENTER TO CENTER

↔ LÄNGE | LENGTH

📦 VERPACKUNGSEINHEIT | PACKING UNIT

↔ BREITE | WIDTH

⊘ DURCHMESSER | DIAMETER

↕ HÖHE | HEIGHT



1530



Edelstahl / stainless steel

Bestellnummer | Order no.  
 1530-134N1  
 1530-166N1  
 1530-198N1  
 1530-294N1  
 1530-358N1  
 1530-454N1



N1

L	B/W	H	LA/CC	VE/PU
134	12	30	128	10
166	12	30	160	10
198	12	30	192	10
294	12	30	288	10
358	12	30	352	10
454	12	30	448	5



Abbildung: 1585-111N1, 1585-207N1

1472



Edelstahl / stainless steel

Bestellnummer | Order no.  
 1472-140N1  
 1472-172N1  
 1472-204N1  
 1472-268N1  
 1472-332N1  
 1472-396N1  
 1472-492N1



N1

L	D	H	LA/CC	VE/PU
140	14	40	128	10
172	14	40	160	10
204	14	40	192	10
268	14	40	256	10
332	14	40	320	10
396	14	40	384	10
492	14	40	480	10

1471



Edelstahl / stainless steel

Bestellnummer | Order no.  
 1471-140N1  
 1471-172N1  
 1471-204N1  
 1471-268N1  
 1471-332N1  
 1471-396N1  
 1471-492N1



N1

L	D	H	LA/CC	VE/PU
140	35	42	128	10
172	35	42	160	10
204	35	42	192	10
268	35	42	256	10
332	35	42	320	10
396	35	42	384	10
492	35	42	480	10

1408



Edelstahl / stainless steel

Bestellnummer | Order no.  
 1408-176N1  
 1408-208N1  
 1408-240N1  
 1408-272N1  
 1408-304N1  
 1408-368N1  
 1408-400N1  
 1408-432N1  
 1408-464N1  
 1408-560N1  
 1408-720N1  
 1408-752N1  
 1408-816N1  
 1408-976N1  
 1408-1040N1  
 1408-1232N1  
 1408-1360N1  
 1408-1488N1  
 1408-1520N1



N1

L	D	H	LA/CC	VE/PU
176	12	32	96	10
208	12	32	128	10
240	12	32	160	10
272	12	32	192	10
304	12	32	224	10
368	12	32	288	10
400	12	32	320	5
432	12	32	352	5
464	12	32	384	5
560	12	32	480	5
720	12	32	640	5
752	12	32	672	5
816	12	32	2x368	5
976	12	32	2x448	5
1040	12	32	2x480	5
1232	12	32	2x576	5
1360	12	32	2x640	5
1488	12	32	2x704	5
1520	12	32	2x720	5

1407



Edelstahl / stainless steel

Bestellnummer | Order no.  
 1407-148N1  
 1407-184N1  
 1407-216N1  
 1407-248N1  
 1407-280N1  
 1407-344N1  
 1407-376N1  
 1407-420N1  
 1407-452N1  
 1407-548N1



N1

L	D	H	LA/CC	VE/PU
148	10	31	96	10
184	10	31	128	10
216	10	31	160	10
248	10	31	192	10
280	10	31	224	10
344	10	31	288	10
376	10	31	320	10
420	10	31	352	5
452	10	31	384	5
548	10	31	480	5

⇔ LOCHABSTAND | CENTER TO CENTER

⇔ LÄNGE | LENGTH

☐ VERPACKUNGSEINHEIT | PACKING UNIT

☐ BREITE | WIDTH

⊘ DURCHMESSER | DIAMETER

☐ HÖHE | HEIGHT



1406



Edelstahl / stainless steel

Bestellnummer | Order no.  
 1406-76N1  
 1406-108N1  
 1406-140N1  
 1406-172N1  
 1406-204N1  
 1406-236N1  
 1406-332N1  
 1406-396N1  
 1406-492N1  
 1406-748N1



N1

L	D	H	LA/CC	VE/PU
77	13	33	64	10
109	13	33	96	10
141	13	33	128	10
173	13	33	160	10
205	13	33	192	10
237	13	33	224	10
333	13	33	320	10
397	13	33	384	10
493	13	33	480	5
749	13	33	736	5

1406H hohl / hollow



Edelstahl / stainless steel

Bestellnummer | Order no.  
 1406H-140N1  
 1406H-172N1



N1

L	D	H	LA/CC	VE/PU
140	12	32	128	10
172	12	32	160	10

1405



Edelstahl / stainless steel

Bestellnummer | Order no.  
 1405-72N1  
 1405-104N1  
 1405-136N1  
 1405-168N1  
 1405-200N1



N1

L	D	H	LA/CC	VE/PU
72	8	30	64	10
104	8	30	96	10
136	8	30	128	10
168	8	30	160	10
200	8	30	192	10



Abbildung: 1408-176N1, 1408-432N1

1404



Edelstahl / stainless steel

Bestellnummer | Order no.  
 1404-10N1  
 1404-15N1  
 1404-18N1  
 1404-21N1  
 1404-30N1



N1

D	D/S	H	VE/PU
10	10	21	10
15	15	22	10
18	18	24	10
21	21	26	10
30	30	31	10

1403



Edelstahl / stainless steel

Bestellnummer | Order no.  
 1403-15N1  
 1403-20N1  
 1403-24N1  
 1403-29N1



N1

D	D/S	H	VE/PU
15	8	20	10
20	11	24	10
24	14	29	10
29	18	35	10

1402



Edelstahl / stainless steel

Bestellnummer | Order no.  
 1402-16N1V2\*

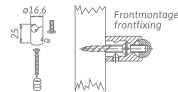

2 Sockel für Relinggriffe mit 12 mm Durchmesser  
 (für Front- oder Wandmontage)  
 2 baseparts for bar handles with a 12 mm diameter  
 (for front- or wallfixing)

\* Bestellnr. für 2 Stück / order no. for 2 pcs.  
 VE / MOQ : 10 = 20 Stück / pieces



N1

D	H	VE/PU
17	25	10

906



Edelstahl / stainless steel

Bestellnummer | Order no.  
 906-42N1  
 906-74N1  
 906-111N1  
 906-145N1  
 906-184N1  
 906-223N1



N1

L	D	H	LA/CC	VE/PU
42	10	32	32	10
74	10	32	64	10
111	10	32	96	10
145	10	32	128	10
184	10	32	160	10
223	10	32	192	10

904



Edelstahl / stainless steel

Bestellnummer | Order no.  
 904-12N1



N1

D	D/S	H	VE/PU
12	12	22	10



903



Edelstahl / stainless steel

Bestellnummer | Order no.  
 903-42N1  
 903-74N1  
 903-111N1  
 903-145N1  
 903-184N1  
 903-223N1  
 903-259N1  
 903-371N1  
 903-485N1



N1

L	D	H	LA/CC	VE/PU
42	10	35	32	10
74	10	35	64	10
111	10	35	96	10
145	10	35	128	10
184	10	35	160	10
223	10	35	192	10
259	10	35	224	10
371	10	35	320	10
485	10	35	416	10

902



Edelstahl / stainless steel

Bestellnummer | Order no.  
 902-15N1  
 902-20N1  
 902-24N1  
 902-28N1  
 902-34N1



N1

D	D/S	H	VE/PU
15	8	17	10
20	9	26	10
25	10	30	10
28	10	33	10
34	12	40	10



Abbildung: 1403-29N1





EDELSTAHL stainless steel

Abbildung: 901-234N1

---

## MADE WITH SWAROVSKI® ELEMENTS

# SPECIAL EDITION

---

*Seit über 120 Jahren stellt das in Österreich gegründete Unternehmen Swarovski präzise geschliffene Kristalle auf Basis erstklassiger Materialien her, die aufgrund ihrer Strahlkraft und der hohen Qualität weltweit beliebt sind. Sie stehen für Eleganz, Exklusivität und Glamour – Eigenschaften, die auch in unserer topaktuellen Kollektion MADE WITH SWAROVSKI ELEMENTS zum Ausdruck kommen.*

*Stilvoll und dezent, mit einem Hauch von Extravaganz lassen sich mit unserer Special Edition außergewöhnliche Akzente setzen und Möbel werden durch diese luxuriösen Accessoires in strahlende Schmuckstücke verwandelt. Die SWAROVSKI ELEMENTS dienen hierbei als Designelemente, die bewusst dekorativ eingesetzt werden, ohne dabei aufdringlich zu wirken.*

*Die Beschläge der Special Edition sind in den Oberflächen Chrom glänzend oder Edelstahleffekt erhältlich und mit SWAROVSKI ELEMENTS veredelt.*

---

## MADE WITH SWAROVSKI® ELEMENTS

# SPECIAL EDITION

---

*For over 120 years, Swarovski has been using first class materials to create precisely cut crystals. Founded in Austria, this company designs products that are loved around the globe for their radiance and high quality. They represent elegance, exclusivity and glamour – qualities that come to life in our brand-new collection, MADE WITH SWAROVSKI ELEMENTS.*

*Stylish and subtle, with a touch of extravagance, this series adds that something special to a space, the luxurious accessories transforming furniture into stunning pieces of jewellery. Here, SWAROVSKI ELEMENTS serve as skilfully placed design elements that add decoration without becoming obtrusive.*

*The Special Edition fittings are available in polished chrome or stainless steel effect and are decorated with SWAROVSKI ELEMENTS.*



SPECIAL EDITION made with Swarovski Elements





---

# KUNSTSTOFF

---

*„Das Material der tausend Möglichkeiten“ – so wurde dieser Werkstoff bereits vor über 100 Jahren von Leo Henrik Baekeland, dem Erfinder des ersten vollständig synthetisch hergestellten Kunststoffes, bezeichnet.*

*Und tatsächlich bietet Kunststoff zahlreiche Anwendungsmöglichkeiten. Die Eigenschaften von Kunststoffprodukten variieren zwar je nach Ausgangsmaterial und Herstellungsverfahren, zu ihren Vorteilen gehören aber, dass sie bruchfest, wasserbeständig und leicht zu reinigen sind. Durch seine schier unbegrenzte Formbarkeit sind bei der Herstellung von Möbelbeschlägen aus Kunststoff der Fantasie kaum Grenzen gesetzt.*

*Von diesen vielfältigen Möglichkeiten haben auch wir in unserem Sortiment aus Kunststoffbeschlägen Gebrauch gemacht. Keine andere Produktgruppe präsentiert sich in derart vielen Formen und Farben – von bunten Farbtupfern in außergewöhnlichen Formen für das Kinderzimmer bis hin zu täuschend echt imitierten Oberflächen in Holz-, Metall- oder Glasoptik.*

*Mit der Serie Smart Touch bieten wir eine Reihe von Beschlägen mit Eingriffsöffnung, die sich für den flächenbündigen Einbau eignen und dank ihrer klaren Optik hervorragend mit modernen Designs harmonieren.*

*Dank der Formen- und Farbenvielfalt dieser Kollektion werden unsere Kunststoffgriffe schnell zum Blickfang in jedem Raum. Sie erlauben es, individuelle Akzente zu setzen und Möbel schnell und einfach optisch aufzuwerten.*

---

# PLASTIC

---

*“The material of a thousand uses” was how Leo Henrik Baekeland, inventor of the first completely synthetic plastic, described this material over 100 years ago. And plastic can indeed be used in many different ways.*

*The properties of plastic products vary depending on the raw materials used and on the production process, but all share numerous advantages: they are break-proof, waterproof and easy to clean. Plastic can be created in almost any shape, meaning that there are practically no limits to what can be done when producing furniture fittings in this material.*

*Our range of plastic fittings exploits the full potential of this material. No other product group can boast this variety of shapes and colours – from sculptured splashes of colour for a child’s bedroom to highly realistic imitation wood, metal or glass items.*

*Our Smart Touch series offers a range of fittings with easy-open buttons suitable for flush mounting. The minimalist style harmonises perfectly with modern designs.*

*The wide range of shapes and colours in this collection make these synthetic fittings an eye-catching addition to any room. They add a touch of individuality and give furniture a quick and easy facelift.*





01045



Bestellnummer | Order no.  
01045-140MV7  
01045-140MV11



Kunststoff / plastic



MV7

MV11

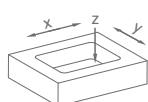

x 135  
y 44  
z 16

Für Frontstärken ab 19 mm geeignet. /  
For front thicknesses from 19 mm suitable.

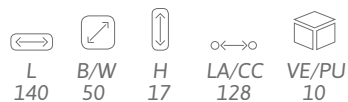

L 140  
B/W 50  
H 17  
LA/CC 128  
VE/PU 10

01031



Bestellnummer | Order no.  
01031-60MV7  
01031-60MV11

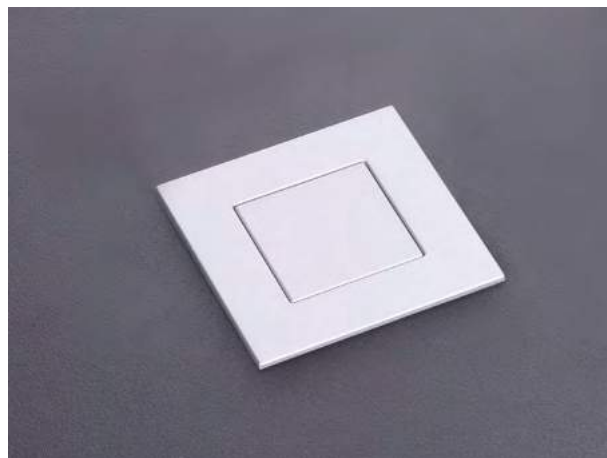

Kunststoff / plastic



MV7

MV11

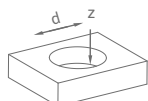

d 55  
z 16

Für Frontstärken ab 19 mm geeignet, mit Zusatzdeckel ab 16 mm. /  
For front thicknesses from 19 mm suitable, with additional cover from 16 mm.



L 60  
B/W 60  
H 20  
LA/CC 48  
VE/PU 10

01028



Bestellnummer | Order no.  
01028-60MV7



Kunststoff / plastic



MV7

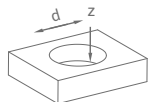

d 55  
z 16

Für Frontstärken ab 19 mm geeignet, mit Zusatzdeckel ab 16 mm. /  
For front thicknesses from 19 mm suitable, with additional cover from 16 mm.

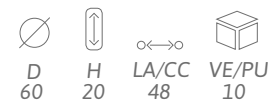

D 60  
H 20  
LA/CC 48  
VE/PU 10

↔ LOCHABSTAND | CENTER TO CENTER

📦 VERPACKUNGSEINHEIT | PACKING UNIT

⊘ DURCHMESSER | DIAMETER

↔ LÄNGE | LENGTH

📏 BREITE | WIDTH

📏 HÖHE | HEIGHT

## Smart Touch

Flächenbündiger Einbau - passend zu modernen Designs!

Smart Touch – ein einfacher Fingerdruck genügt und Ihre Schublade, Schiebetür, Klappe oder Drehtür kann problemlos mit der entstandenen Eingriffsöffnung betätigt werden.

Die klare und einfache Optik harmonisiert hervorragend mit modernen Einrichtungskonzepten und lässt auch funktionell keine Wünsche offen.

Flush-mount installation – suitable for modern designs!

Smart Touch – a simple push of a finger is enough to easily open your drawer, sliding door, shutter or revolving door, by inserting your hand in the resulting opening.

The clear-cut, simple look perfectly harmonises with modern interior design concepts and leaves nothing to be desired in terms of functionality.

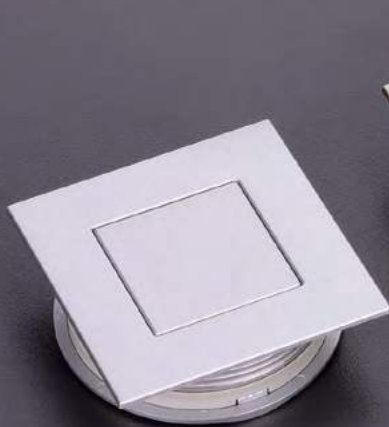

01031-60MV11

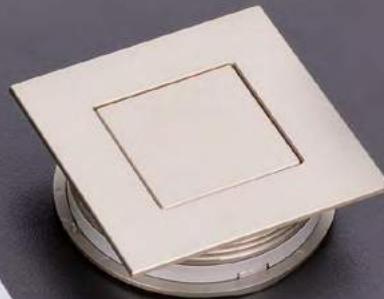

01031-60MV7



01045-140MV7

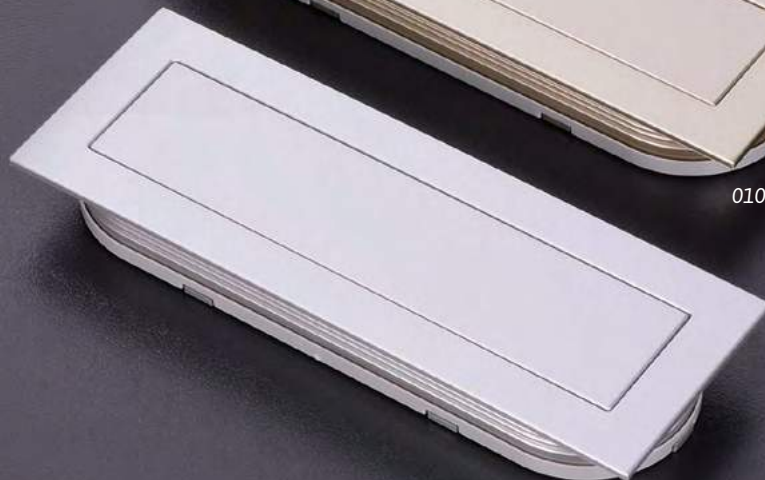

01045-140MV11



01028-60MV7

01061



Kunststoff / plastic

Bestellnummer | Order no.  
01061-153K1K60  
01061-153K60K1



K1K60

K60K1

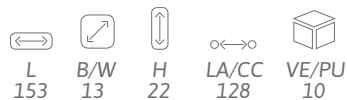

01060



Kunststoff / plastic

Bestellnummer | Order no.  
01060-30K1K60  
01060-30K60K1



K1K60

K60K1

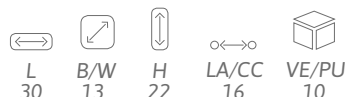

01057



Kunststoff / plastic

Bestellnummer | Order no.  
01057-40K1CF1



K1CF1



01056



Kunststoff / plastic

Bestellnummer | Order no.  
01056-30K1K60  
01056-30K60K1



K1K60

K60K1

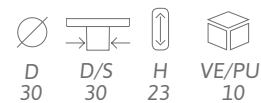

01055



Kunststoff / plastic

Bestellnummer | Order no.  
01055-149K1K60



K1K60





Abbildung: 01055-149K1K60

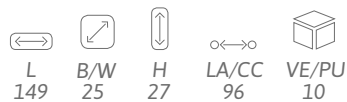

Abbildung: 01056-30K60K1, 01061-153K60K1, 01061-153K1K60, 01060-30K60K1, 01056-30K1K60, 01060-30K1K60

01023



Kunststoff / plastic

Bestellnummer | Order no.  
01023-34K60CF3CF7



K60CF3CF7

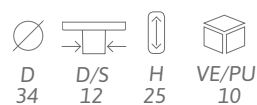

D 34 D/S 12 H 25 VE/PU 10

01011



Kunststoff / plastic

Bestellnummer | Order no.  
01011-105MV11



MV11

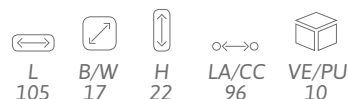

L 105 B/W 17 H 22 LA/CC 96 VE/PU 10

01006



Kunststoff / plastic

Bestellnummer | Order no.  
01006-36K7  
01006-36K10  
01006-36MT1



K7 K10 MT1

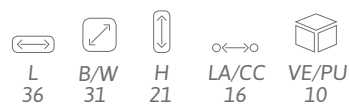

L 36 B/W 31 H 21 LA/CC 16 VE/PU 10

0976



Kunststoff / plastic

Bestellnummer | Order no.  
0976-146MV11



MV11

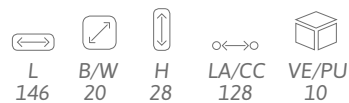

L 146 B/W 20 H 28 LA/CC 128 VE/PU 10

0952



Kunststoff / plastic

Bestellnummer | Order no.  
0952-142MT1  
0952-142MV7  
0952-142MV11



MT1 MV7 MV11



L 142 B/W 14 H 27 LA/CC 128 VE/PU 10

0951



Kunststoff / plastic

Bestellnummer | Order no.  
0951-136MV7  
0951-136MV11  
0951-167MV7  
0951-167MV11



MV7

MV11





				
L	B/W	H	LA/CC	VE/PU
136	16	32	96	10
167	16	32	128	10



Abbildung: 0951-167MV11

0839



Kunststoff / plastic

Bestellnummer | Order no.  
0839-106MF18MV11  
0839-138MF18MV11



MF18MV11

L	B/W	H	LA/CC	VE/PU
106 138	14	24	96 128	10 10

0824



Kunststoff / plastic

Bestellnummer | Order no.  
0824-123KM1MV11  
0824-123KM3MV11  
0824-155KM1MV11  
0824-155KM3MV11



KM1MV11 KM3MV11

L	B/W	H	LA/CC	VE/PU
123 155	26 28	28 29	96 128	10 10

0823



Kunststoff / plastic

Bestellnummer | Order no.  
0823-29KM1MV11  
0823-29KM3MV11



KM1MV11 KM3MV11

L	B/W	H	VE/PU	
29	29	23	10	

0819



Kunststoff / plastic

Bestellnummer | Order no.  
0819-28MV11MV11



MV11MV11

L	B/W	H	LA/CC	VE/PU
28	28	25	16	10

Passend zu 0858 Seite 339, 0859 Seite 338  
matching 0858 page 339, 0859 page 338

0771



Kunststoff / plastic

Bestellnummer | Order no.  
0771-127K10MT1  
0771-127KGSU1MT1  
0771-127KGSU3MT1  
0771-127KGSU4MT1  
0771-159K10MT1  
0771-159KGSU1MT1  
0771-159KGSU3MT1



K10MT1 KGSU1MT1 KGSU3MT1 KGSU4MT1

L	B/W	H	LA/CC	VE/PU
127 159	18	33	96 128	10 10



0765



Kunststoff / plastic

Bestellnummer | Order no.  
 0765-29KGSU1MT1  
 0765-29KGSU1MV7  
 0765-29KGSU4MT1  
 0765-29MV7MV7  
 0765-29T7MV11  
 0765-34KGSU1MT1



KGSU1MT1 KGSU1MV7 KGSU4MT1 MV7MV7



T7MV11

D	D/S	H	VE/PU
29	16	38	10
34	16	43	10

0753



Kunststoff / plastic

Bestellnummer | Order no.  
 0753-55MV11MT1



MV11MT1

L	B/W	H	LA/CC	VE/PU
55	25	25	32	10



Abbildung: 0771-127KGSU1MT1, 0765-34KGSU1MT1

0715



Kunststoff / plastic

Bestellnummer | Order no.  
0715-179MV7MV7  
0715-179MV11MV11

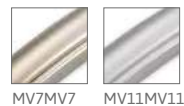

MV7MV7 MV11MV11

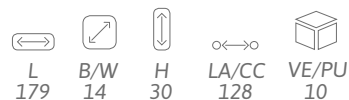

0706



Kunststoff / plastic

Bestellnummer | Order no.  
0706-16VGMV7



VGMV7



0695



Kunststoff - Druckguss mit M4 Gewinde /  
plastic - die cast with M4 thread

Bestellnummer | Order no.  
0695-34KM1ZN4  
0695-40KM1ZN4



KM1ZN4

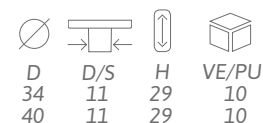

0653



Kunststoff / plastic

Bestellnummer | Order no.  
0653-139MC23MV7  
0653-171KM9MT7



KM9MT7 MC23MV7

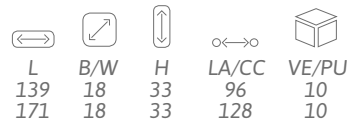

0621



Kunststoff / plastic

Bestellnummer | Order no.  
0621-30MV11MV11  
0621-30T16MT1



MV11MV11 T16MT1

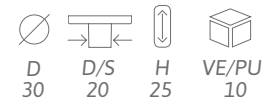

0619



Kunststoff / plastic

Bestellnummer | Order no.  
0619-18T7



T7

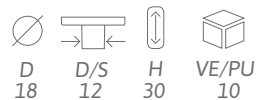

0618



Kunststoff / plastic

Bestellnummer | Order no.  
0618-64T7  
0618-64VGMV11



T7



VGMV11



Passend zu 0616, 0617 Seite 340  
matching 0616, 0617 page 340

M618



Kunststoff mit M4 Metallgewinde /  
plastic with M4 metalthread

Bestellnummer | Order no.  
M618-64VG1



VG1



Abbildung: 0715-179MV11MV11

0606

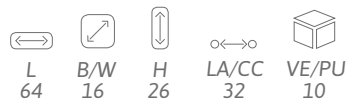

Kunststoff / plastic

Bestellnummer | Order no.  
0606-154K1MT1  
0606-154K10MT3  
0606-154K19MT1



L	B/W	H	LA/CC	VE/PU
154	12	28	128	10

0602



Kunststoff / plastic

Bestellnummer | Order no.  
0602-113MV11



L	B/W	H	LA/CC	VE/PU
113	31	25	64	10

0571



Kunststoff / plastic

Bestellnummer | Order no.  
0571-35MV11



L	B/W	H	LA/CC	VE/PU
35	20	23	16	10

0563



Kunststoff / plastic

Bestellnummer | Order no.  
0563-134MV7  
0563-134MV11  
0563-166MV11



L	B/W	H	LA/CC	VE/PU
134 166	10 10	28 30	96 128	10 10

0556



Kunststoff / plastic

Bestellnummer | Order no.  
0556-134K10  
0556-134K52  
0556-166K10



L	B/W	H	LA/CC	VE/PU
134 166	16 17	28 30	96 128	10 10

0551



Kunststoff / plastic



VGMV11

Bestellnummer | Order no.  
0551-32VGMV11  
0551-39VGMV11

D	D/S	H	VE/PU
32	21	28	10
39	24	31	10



Abbildung: 0556-134K52

0549



Kunststoff / plastic

Bestellnummer | Order no.  
0549-97MV11



MV11

L	B/W	H	LA/CC	VE/PU
97	10	25	64	10

A549



Kunststoff mit M4 Gewinde /  
plastic with M4 thread

Bestellnummer | Order no.  
A549-134E2  
A549-134K10  
A549-134MV11  
A549-166E2



E2 K10 MV11

L	B/W	H	LA/CC	VE/PU
134 166	11 11	28 30	96 128	10 10

M549



Kunststoff mit M4 Metallgewinde /  
plastic with M4 metalthread

Bestellnummer | Order no.  
M549-97E2



E2

L	B/W	H	LA/CC	VE/PU
97	10	25	64	10

0540



Kunststoff / plastic

Bestellnummer | Order no.  
0540-117K10



K10

L	B/W	H	LA/CC	VE/PU
117	14	25	96	10

0516



Kunststoff / plastic

Bestellnummer | Order no.  
0516-25VGMV11



VGMV11

D	D/S	H	VE/PU
25	13	25	10

0511



Kunststoff / plastic

Bestellnummer | Order no.  
 0511-130K10  
 0511-130MV7  
 0511-130MV11



L 130	B/W 12	H 28	LA/CC 96	VE/PU 10

0506



Kunststoff / plastic

Bestellnummer | Order no.  
 0506-20VGMV11  
 0506-28VGMV11



D 20 28	D/S 10 14	H 23 25	VE/PU 10 10

0503



Kunststoff / plastic

Bestellnummer | Order no.  
 0503-15K1  
 0503-15K10  
 0503-15MT1  
 0503-15MV7  
 0503-15MV11



D 15	D/S 9	H 24	VE/PU 10



Abbildung: 0549-97MV11

0475H



Kunststoff / plastic

Bestellnummer | Order no.  
 0475H-22K10  
 0475H-30K10  
 0475H-30K52  
 0475H-30MV11



D	D/S	H	VE/PU
22	22	22	10
30	30	30	10

0453



Kunststoff / plastic

Bestellnummer | Order no.  
 0453-25VGMV11  
 0453-29VGMV7  
 0453-34VGMV11



D	D/S	H	VE/PU
25	14	26	10
29	16	30	10
34	18	35	10

0443H



Kunststoff / plastic

Bestellnummer | Order no.  
 0443H-128K10  
 0443H-128K52



L	B/W	H	LA/CC	VE/PU
128	18	24	96	10

0436



Kunststoff / plastic

Bestellnummer | Order no.  
 0436-85K10  
 0436-85MV11



L	B/W	H	LA/CC	VE/PU
85	10	26	64	10

0434



Kunststoff / plastic

Bestellnummer | Order no.  
 0434-112SF224



L	B/W	H	VE/PU
112	46	9	10

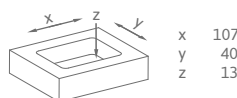

↔ LOCHABSTAND | CENTER TO CENTER

↔ LÄNGE | LENGTH

☐ VERPACKUNGSEINHEIT | PACKING UNIT

↔ BREITE | WIDTH

⊘ DURCHMESSER | DIAMETER

⊞ HÖHE | HEIGHT



0428



Kunststoff / plastic

Bestellnummer | Order no.  
0428-112K10  
0428-112MV7

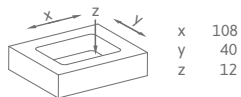

K10

MV7

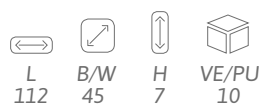

0391



Kunststoff / plastic

Bestellnummer | Order no.  
0391-30MT1MV11  
0391-34MT1MV11  
0391-34MV7MC23



MT1MV11

MV7MC23

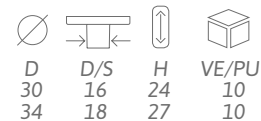

0387



Kunststoff / plastic

Bestellnummer | Order no.  
0387-76K10  
0387-108K10  
0387-108MV11



K10

MV11



Abbildung: 0475H-30K10

0385

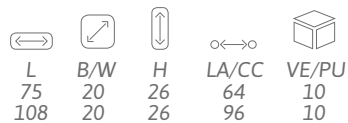

Kunststoff / plastic

Bestellnummer | Order no.  
 0385-32K1  
 0385-32K2  
 0385-32K10  
 0385-32K19  
 0385-32K31  
 0385-32K52  
 0385-32K60DK5  
 0385-32MT1  
 0385-32MT3  
 0385-32MV7  
 0385-32MV11  
 0385-40K1  
 0385-40K2  
 0385-40K10  
 0385-40K19  
 0385-40K31  
 0385-40K52  
 0385-40MV7  
 0385-40MV11



D	D/S	H	VE/PU
32	18	27	10
40	23	31	10

0364



Kunststoff / plastic

Bestellnummer | Order no.  
 0364-80K1  
 0364-80K2  
 0364-80K10  
 0364-80K19  
 0364-80K31  
 0364-80K52  
 0364-80MV7  
 0364-112K1  
 0364-112K2  
 0364-112K10  
 0364-112K19  
 0364-112K31  
 0364-112K52  
 0364-112MV7  
 0364-144K10  
 0364-144MV7



L	B/W	H	LA/CC	VE/PU
80	16	30	64	10
112	16	30	96	10
144	16	30	128	10

0297



Kunststoff / plastic

Bestellnummer | Order no.  
 0297-168MV11



MV11

L	B/W	H	LA/CC	VE/PU
167	16	26	128	10

0294



Kunststoff / plastic

Bestellnummer | Order no.  
 0294-30K10



K10

D	D/S	H	VE/PU
30	14	29	10





0291



Kunststoff / plastic

Bestellnummer | Order no.  
 0291-28K1  
 0291-28K10  
 0291-28K52  
 0291-28MV11



			
D	D/S	H	VE/PU
28	14	20	10





0287



Kunststoff / plastic

Bestellnummer | Order no.  
 0287-73K2  
 0287-73K10  
 0287-73MV7  
 0287-106K2  
 0287-106K10  
 0287-106MV7



				
L	B/W	H	LA/CC	VE/PU
73	9	28	64	10
106	10	28	96	10





0192



Kunststoff / plastic

Bestellnummer | Order no.  
 0192-40K10  
 0192-40K52



			
D	D/S	H	VE/PU
40	14	22	10

0104



Kunststoff / plastic

Bestellnummer | Order no.  
 0104-35K10  
 0104-35K52  
 0104-47K10  
 0104-47K52







			
D	D/S	H	VE/PU
35	18	19	10
47	29	20	10



Abbildung: 0385-32K60DK5

H243



Softmaterial - Metallfuß mit M4 Gewinde /  
soft material - metal base with M4 thread

Bestellnummer | Order no.  
H243-50RU47

keine Verletzungsgefahr /  
no risk on injury



RU47

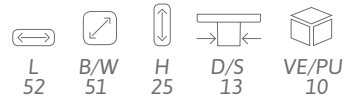

H242



Softmaterial - Metallfuß mit M4 Gewinde /  
soft material - metal base with M4 thread

Bestellnummer | Order no.  
H242-62RU46

keine Verletzungsgefahr /  
no risk on injury



RU46

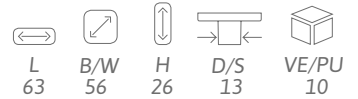

H241



Softmaterial - Metallfuß mit M4 Gewinde /  
soft material - metal base with M4 thread

Bestellnummer | Order no.  
H241-55RU45

keine Verletzungsgefahr /  
no risk on injury



RU45

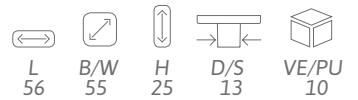

H235



Softmaterial - Metallfuß mit M4 Gewinde /  
soft material - metal base with M4 thread

Bestellnummer | Order no.  
H235-50RU44

keine Verletzungsgefahr /  
no risk on injury



RU44

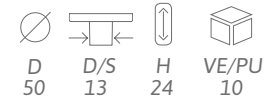

H234



Softmaterial - Metallfuß mit M4 Gewinde /  
soft material - metal base with M4 thread

Bestellnummer | Order no.  
H234-50RU42  
H234-50RU43

keine Verletzungsgefahr /  
no risk on injury



RU42



RU43

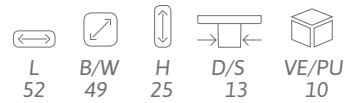

H233



Softmaterial - Metallfuß mit M4 Gewinde /  
soft material - metal base with M4 thread

Bestellnummer | Order no.  
H233-52RU40  
H233-52RU41

keine Verletzungsgefahr /  
no risk on injury



RU40

RU41

L	B/W	H	D/S	VE/PU
54	59	26	13	10



H210R Rechtsausführung / right finish



Softmaterial - Metallfuß mit M4 Gewinde /  
soft material - metal base with M4 thread

Bestellnummer | Order no.  
H210R-70RU36

keine Verletzungsgefahr /  
no risk on injury



RU36



H210L Linksausführung / left finish



Softmaterial - Metallfuß mit M4 Gewinde /  
soft material - metal base with M4 thread

Bestellnummer | Order no.  
H210L-70RU36

keine Verletzungsgefahr /  
no risk on injury



RU36

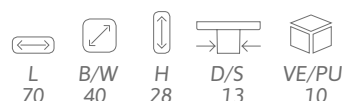

H159



Softmaterial - Metallfuß mit M4 Gewinde /  
soft material - metal base with M4 thread

Bestellnummer | Order no.  
H159-50RU15

keine Verletzungsgefahr /  
no risk on injury



RU15

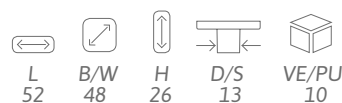

H158



Softmaterial - Metallfuß mit M4 Gewinde /  
soft material - metal base with M4 thread

Bestellnummer | Order no.  
H158-51RU14

keine Verletzungsgefahr /  
no risk on injury



RU14

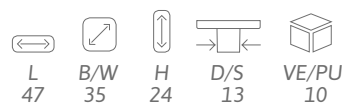

H157



Softmaterial - Metallfuß mit M4 Gewinde /  
soft material - metal base with M4 thread

Bestellnummer | Order no.  
H157-50RU13

keine Verletzungsgefahr /  
no risk on injury



RU13

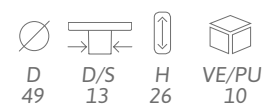

H156

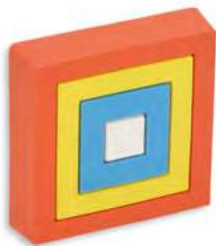

Softmaterial - Metallfuß mit M4 Gewinde /  
soft material - metal base with M4 thread

Bestellnummer | Order no.  
H156-40RU12

keine Verletzungsgefahr /  
no risk on injury



RU12

L	B/W	H	D/S	VE/PU
41	41	23	13	10

H152



Softmaterial - Metallfuß mit M4 Gewinde /  
soft material - metal base with M4 thread

Bestellnummer | Order no.  
H152-44RU8

keine Verletzungsgefahr /  
no risk on injury



RU8

L	B/W	H	D/S	VE/PU
50	46	24	13	10



Abbildung: H210R-70RU36, H210L-70RU36

H150



Bestellnummer | Order no.  
H150-53RU6

Softmaterial - Metallfuß mit M4 Gewinde /  
soft material - metal base with M4 thread

keine Verletzungsgefahr /  
no risk on injury



RU6

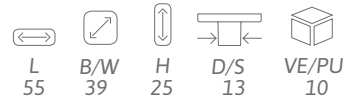

H149



Bestellnummer | Order no.  
H149-44RU3  
H149-44RU4  
H149-44RU5

Softmaterial - Metallfuß mit M4 Gewinde /  
soft material - metal base with M4 thread

keine Verletzungsgefahr /  
no risk on injury



RU3

RU4

RU5

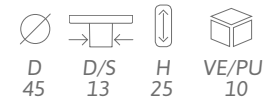

H148



Bestellnummer | Order no.  
H148-40RU2

Softmaterial - Metallfuß mit M4 Gewinde /  
soft material - metal base with M4 thread

keine Verletzungsgefahr /  
no risk on injury



RU2

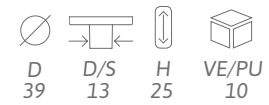

Passend zu H198, H199 Seite 356  
matching H198, H199 page 356

H147



Bestellnummer | Order no.  
H147-47RU1

Softmaterial - Metallfuß mit M4 Gewinde /  
soft material - metal base with M4 thread

keine Verletzungsgefahr /  
no risk on injury



RU1

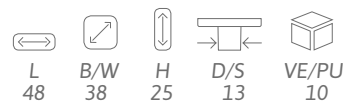

H072

handbemalt / hand painted



Bestellnummer | Order no.  
H072-59PU4FE2

Softmaterial - Metallfuß mit M4 Gewinde /  
soft material - metal base with M4 thread

keine Verletzungsgefahr /  
no risk on injury



PU4FE2







Abbildung: H150-53RU6

H144 handbemalt / hand painted



Kunststoff / plastic

Bestellnummer | Order no.  
H144-36A68



A68

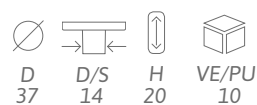

H143 handbemalt / hand painted



Kunststoff mit M4 Metallmuffe/  
plastic with M4 metal thread

Bestellnummer | Order no.  
H143-40A66  
H143-40A67



A66

A67

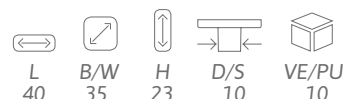

H127 handbemalt / hand painted



Kunststoff mit M4 Metallmuffe/  
plastic with M4 metal thread

Bestellnummer | Order no.  
H127-38A58  
H127-38A59



A58

A59

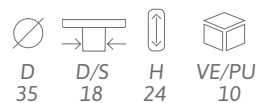

H126 handbemalt / hand painted



Kunststoff mit M4 Metallmuffe/  
plastic with M4 metal thread

Bestellnummer | Order no.  
H126-50A56  
H126-50A57

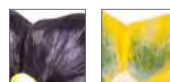

A56

A57

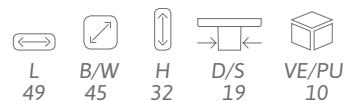

H125 handbemalt / hand painted



Kunststoff mit M4 Metallmuffe/  
plastic with M4 metal thread

Bestellnummer | Order no.  
H125-50A55



A55

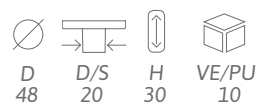

Passend zu 1789 Seite 308  
matching 1789 page 308

↔ LOCHABSTAND | CENTER TO CENTER

↔ LÄNGE | LENGTH

📦 VERPACKUNGSEINHEIT | PACKING UNIT

↔ BREITE | WIDTH

⊘ DURCHMESSER | DIAMETER

📏 HÖHE | HEIGHT

H124 handbemalt / hand painted



Kunststoff mit M4 Metallmuffe/  
plastic with M4 metal thread

Bestellnummer | Order no.  
H124-50A54



A54

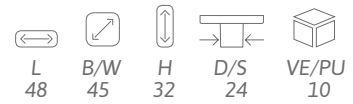

H123 handbemalt / hand painted



Kunststoff mit M4 Metallmuffe/  
plastic with M4 metal thread

Bestellnummer | Order no.  
H123-50A54



A54

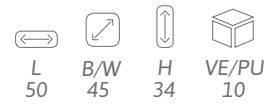

Passend zu 1788 Seite 308  
matching 1788 page 308

H122 handbemalt / hand painted



Kunststoff mit M4 Metallmuffe/  
plastic with M4 metal thread

Bestellnummer | Order no.  
H122-50A53  
H122-50A59



A53



A59

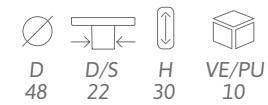

Passend zu 1787 Seite 308  
matching 1787 page 308



Abbildung: H122-50A59

H197



Bestellnummer | Order no.  
H197-230A110A13

Softmaterial - Kunststoff mit M4 Metallmuffe /  
soft materiel - plastic with M4 metal thread



A110A13

L	B/W	H	LA/CC	VE/PU
217	25	34	192/flex	10

H121



Bestellnummer | Order no.  
H121-74A3V2\*  
H121-74A4V2\*  
H121-106A3V2\*  
H121-106A4V2\*  
H121-138A3V2\*  
H121-138A4V2\*

Kunststoff / plastic



A3

A4

L	B/W	H	LA/CC	VE/PU
74	10	34	64	5
106	10	34	96	5
138	10	34	128	5

\* Bestellnr. für 2 Stück / order no. for 2 pcs.  
VE / MOQ : 5 = 10 Stück / pieces

H119



Bestellnummer | Order no.  
H119-38GE1ZN1  
H119-38GE1ZN20

Kunststoff - Druckguss mit M4 Gewinde /  
plastic - die cast with M4 thread

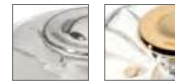

GE1ZN1

GE1ZN20

D	D/S	H	VE/PU
38	21	31	10

H118



Kunststoff / plastic

Bestellnummer | Order no.  
H118-35A13V2\*

\* Bestellnr. für 2 Stück / order no. for 2 pcs.  
VE / MOQ : 5 = 10 Stück / pieces



A13

D	D/S	H	VE/PU
35	13	20	5

H117



Kunststoff / plastic

Bestellnummer | Order no.  
H117-36A51V2\*

\* Bestellnr. für 2 Stück / order no. for 2 pcs.  
VE / MOQ : 5 = 10 Stück / pieces



A51

L	B/W	H	D/S	VE/PU
36	31	21	14	5



Abbildung: H119-38GE1ZN1

H110 handbemalt / hand painted



Kunststoff mit M4 Metallmuffe/  
plastic with M4 metal thread

Bestellnummer | Order no.  
H110-50A44



A44

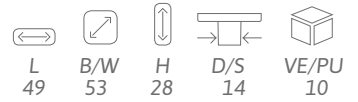

H109 handbemalt / hand painted



Kunststoff mit M4 Metallmuffe/  
plastic with M4 metal thread

Bestellnummer | Order no.  
H109-53A43



A43

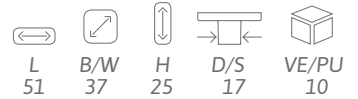

H108 handbemalt / hand painted



Kunststoff mit M4 Metallmuffe/  
plastic with M4 metal thread

Bestellnummer | Order no.  
H108-44A42



A42

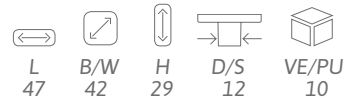

H107 handbemalt / hand painted



Kunststoff mit M4 Metallmuffe/  
plastic with M4 metal thread

Bestellnummer | Order no.  
H107-48A41



A41

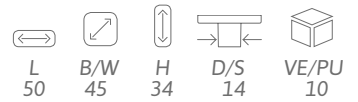

H106 handbemalt / hand painted



Kunststoff mit M4 Metallmuffe/  
plastic with M4 metal thread

Bestellnummer | Order no.  
H106-38A40



A40

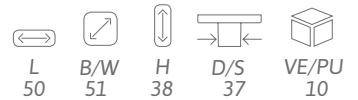

H105

handbemalt / hand painted



Kunststoff mit M4 Metallmuffe/  
plastic with M4 metal thread



A39

Bestellnummer | Order no.  
H105-64A39

L 63	B/W 51	H 30	D/S 15	VE/PU 10



Abbildung: H105-64A39

H138



Kunststoff mit M4 Metallmuffe/  
plastic with M4 metal thread

Bestellnummer | Order no.  
H138-73A15



A15

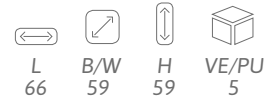

H135



Kunststoff mit M4 Metallmuffe/  
plastic with M4 metal thread

Bestellnummer | Order no.  
H135-48A15  
H135-48A28



A15



A28

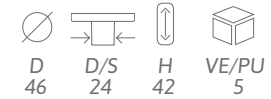

H087



Kunststoff mit M4 Metallmuffe/  
plastic with M4 metal thread

Bestellnummer | Order no.  
H087-45A28



A28

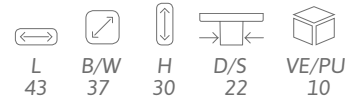

H086



Kunststoff mit M4 Metallmuffe/  
plastic with M4 metal thread

Bestellnummer | Order no.  
H086-50A15



A15

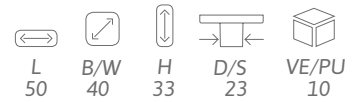

H085



Kunststoff mit M4 Metallmuffe/  
plastic with M4 metal thread

Bestellnummer | Order no.  
H085-45A28



A28





H084



Kunststoff mit M4 Metallmuffe/  
plastic with M4 metal thread



A28

Bestellnummer | Order no.  
H084-32A28

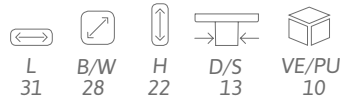

H083



Kunststoff mit M4 Metallmuffe/  
plastic with M4 metal thread



A28

Bestellnummer | Order no.  
H083-33A28

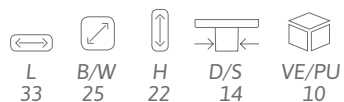

H082



Kunststoff mit M4 Metallmuffe/  
plastic with M4 metal thread

Bestellnummer | Order no.  
H082-50A15  
H082-50A28

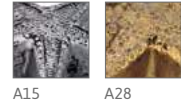

L	B/W	H	D/S	VE/PU
48	44	20	12	10

H104



Kunststoff mit M4 Metallmuffe/  
plastic with M4 metal thread

Bestellnummer | Order no.  
H104-49A38



L	B/W	H	D/S	VE/PU
48	45	35	19	10

H101



Kunststoff mit M4 Metallmuffe/  
plastic with M4 metal thread

Bestellnummer | Order no.  
H101-36A15  
H101-36A28

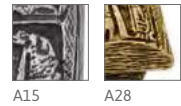

L	B/W	H	VE/PU
34	34	29	10

H100



Kunststoff mit M4 Metallmuffe/  
plastic with M4 metal thread

Bestellnummer | Order no.  
H100-48A15  
H100-48A28

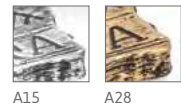

L	B/W	H	VE/PU
48	46	31	10

H099



Kunststoff mit M4 Metallmuffe/  
plastic with M4 metal thread

Bestellnummer | Order no.  
H099-74A15  
H099-74A28

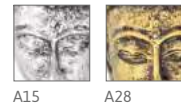

L	B/W	H	VE/PU
72	42	48	10



KUNSTSTOFF plastic

Abbildung: H100-48A28

0903



Bestellnummer | Order no.  
0903-48KMSU7ZN1



KMSU7ZN1

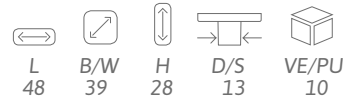

Kunststoff - Metallfuß mit M4 Gewinde /  
plastic - metal base with M4 thread

0902



Bestellnummer | Order no.  
0902-52KMSU5ZN1



KMSU5ZN1

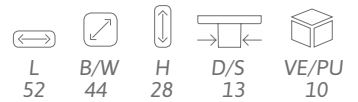

Kunststoff - Metallfuß mit M4 Gewinde /  
plastic - metal base with M4 thread

H078



Bestellnummer | Order no.  
H078-48GE8MS4  
H078-48GE28MS4



GE8MS4



GE28MS4

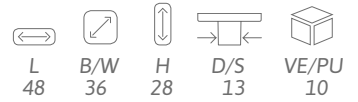

Kunststoff - Metallfuß mit M4 Gewinde /  
plastic - metal base with M4 thread



Montage in beiden Richtungen möglich. / Application in both directions possible.  
für Art.Nr.: / for item no: 0903



Abbildung: 0902-52KMSU5ZN1

H068 handbemalt / hand painted

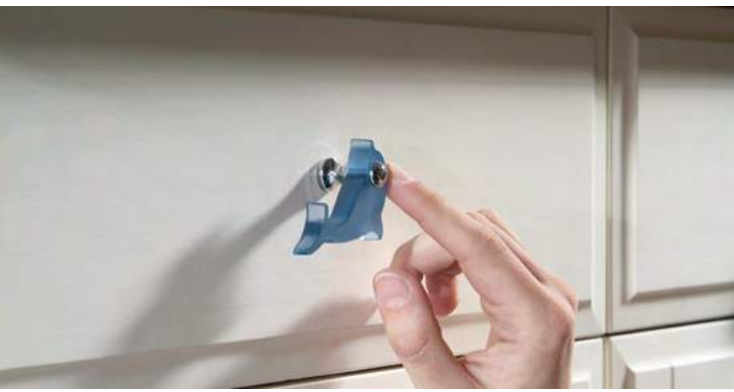

Kunststoff mit M4 Metallmuffe/  
plastic with M4 metal thread

Bestellnummer | Order no.  
H068-53A25



A25

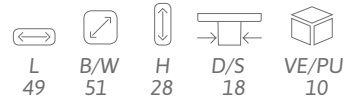

H067 handbemalt / hand painted



Kunststoff mit M4 Metallmuffe/  
plastic with M4 metal thread

Bestellnummer | Order no.  
H067-39A24



A24

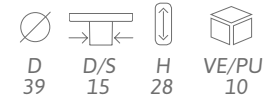

H065 handbemalt / hand painted



Kunststoff mit M4 Metallmuffe/  
plastic with M4 metal thread

Bestellnummer | Order no.  
H065-40A22



A22

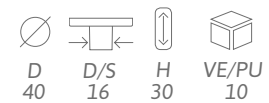

H064 handbemalt / hand painted



Kunststoff mit M4 Metallmuffe/  
plastic with M4 metal thread

Bestellnummer | Order no.  
H064-47A20



A20

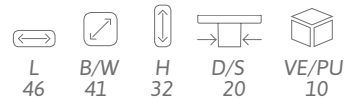

H061 handbemalt / hand painted



Kunststoff mit M4 Metallmuffe/  
plastic with M4 metal thread

Bestellnummer | Order no.  
H061-49A18



A18

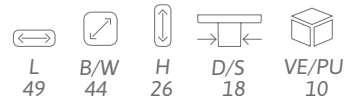

H060 handbemalt / hand painted



Kunststoff mit M4 Metallmuffe/  
plastic with M4 metal thread



A17

Bestellnummer | Order no.  
H060-43A17





				
L 43	B/W 42	H 28	D/S 18	VE/PU 10



Abbildung: H060-43A17

H050



Kunststoff mit M4 Metallmuffe/  
plastic with M4 metal thread

Bestellnummer | Order no.  
H050-57A29



A29

L 55	B/W 37	H 23	VE/PU 10

H049

handbemalt / hand painted



Kunststoff mit M4 Metallmuffe/  
plastic with M4 metal thread

Bestellnummer | Order no.  
H049-41A9



A9

L 40	B/W 47	H 28	VE/PU 10

H048

handbemalt / hand painted



Kunststoff mit M4 Metallmuffe/  
plastic with M4 metal thread

Bestellnummer | Order no.  
H048-41A9



A9

L 40	B/W 45	H 26	VE/PU 10

H047

handbemalt / hand painted



Kunststoff mit M4 Metallmuffe/  
plastic with M4 metal thread

Bestellnummer | Order no.  
H047-40A9



A9

L 39	B/W 46	H 27	VE/PU 10

H046

handbemalt / hand painted



Kunststoff mit M4 Metallmuffe/  
plastic with M4 metal thread

Bestellnummer | Order no.  
H046-47A9



A9

L 45	B/W 47	H 27	VE/PU 10





Abbildung: H049-41A9

H045 handbemalt / hand painted



Kunststoff mit M4 Metallmuffe/  
plastic with M4 metal thread

Bestellnummer | Order no.  
H045-40A9



A9



H044 handbemalt / hand painted



Kunststoff mit M4 Metallmuffe/  
plastic with M4 metal thread

Bestellnummer | Order no.  
H044-42A9



A9



H043 handbemalt / hand painted



Kunststoff mit M4 Metallmuffe/  
plastic with M4 metal thread

Bestellnummer | Order no.  
H043-40A9



A9



H042 handbemalt / hand painted



Kunststoff mit M4 Metallmuffe/  
plastic with M4 metal thread

Bestellnummer | Order no.  
H042-42A9



A9



H041 handbemalt / hand painted



Kunststoff mit M4 Metallmuffe/  
plastic with M4 metal thread

Bestellnummer | Order no.  
H041-42A9



A9



H040 handbemalt / hand painted



Kunststoff mit M4 Metallmuffe/  
plastic with M4 metal thread

Bestellnummer | Order no.  
H040-40A9



A9

L	B/W	H	VE/PU
39	48	29	10

H039 handbemalt / hand painted



Kunststoff mit M4 Metallmuffe/  
plastic with M4 metal thread

Bestellnummer | Order no.  
H039-44A9



A9

L	B/W	H	VE/PU
44	48	26	10



Abbildung: H039-44A9

H030 handbemalt / hand painted



Kunststoff mit M4 Metallmuffe/  
plastic with M4 metal thread

Bestellnummer | Order no.  
H030-49A9



A9

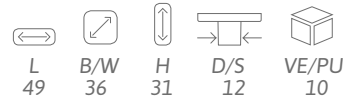

H029 handbemalt / hand painted



Kunststoff mit M4 Metallmuffe/  
plastic with M4 metal thread

Bestellnummer | Order no.  
H029-52A9



A9

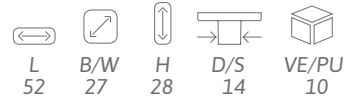

H028 handbemalt / hand painted



Kunststoff mit M4 Metallmuffe/  
plastic with M4 metal thread

Bestellnummer | Order no.  
H028-48A9



A9

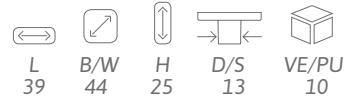

H027 handbemalt / hand painted



Kunststoff mit M4 Metallmuffe/  
plastic with M4 metal thread

Bestellnummer | Order no.  
H027-57A9



A9

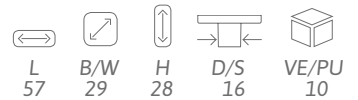

H026 handbemalt / hand painted



Kunststoff mit M4 Metallmuffe/  
plastic with M4 metal thread

Bestellnummer | Order no.  
H026-61A9



A9

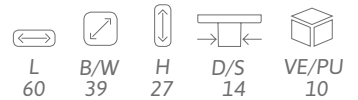

H025 handbemalt / hand painted



Kunststoff mit M4 Metallmuffe/  
plastic with M4 metal thread

Bestellnummer | Order no.  
H025-57A9



A9

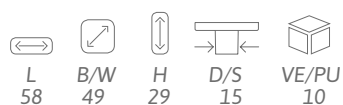

H024 handbemalt / hand painted



Kunststoff mit M4 Metallmuffe/  
plastic with M4 metal thread

Bestellnummer | Order no.  
H024-65A9



A9

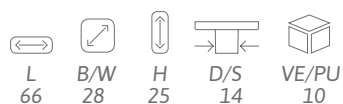

H023 handbemalt / hand painted



Kunststoff mit M4 Metallmuffe/  
plastic with M4 metal thread

Bestellnummer | Order no.  
H023-55A9



A9

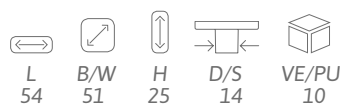

H022 handbemalt / hand painted



Kunststoff mit M4 Metallmuffe/  
plastic with M4 metal thread

Bestellnummer | Order no.  
H022-56A9



A9



Abbildung: H024-65A9

SM8196F

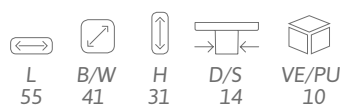

Kunststoff mit M4 Gewinde / plastic with M4 thread

Bestellnummer | Order no.  
SM8196F-83MT1SN1



MT1SN1



SM8195I



Kunststoff mit M4 Metallmuffe / plastic with M4 metal thread

Bestellnummer | Order no.  
SM8195I-24MT1SN1



MT1SN1



SM8194I



Kunststoff mit M4 Metallmuffe / plastic with M4 metal thread

Bestellnummer | Order no.  
SM8194I-24MT1SN1



MT1SN1



SM8189I



Kunststoff mit M4 Metallmuffe / plastic with M4 metal thread

Bestellnummer | Order no.  
SM8189I-65K1  
SM8189I-65K60



K1



K60



SM8187I



Kunststoff mit M4 Metallmuffe / plastic with M4 metal thread

Bestellnummer | Order no.  
SM8187I-150GL36MT1



GL36MT1





Abbildung: SM8196F-83MT1SN1, SM8195I-24MT1SN1

SM8257F



Kunststoff mit M4 Gewinde / plastic with M4 thread

Bestellnummer | Order no.  
 SM8257F-58GL36TX1  
 SM8257F-58GL39TX1  
 SM8257F-58GL41TX1

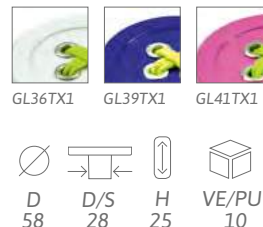

SM8004

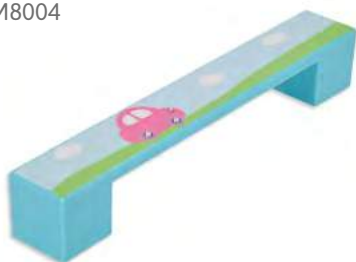

SM8004F Kunststoff mit M4 Gewinde /plastic with M4 thread  
 SM8004I Kunststoff mit M4 Metallmuffe /plastic with M4 metal thread

Passend zu SM8177 Seite 374  
 matching SM8177 page 374

Bestellnummer | Order no.  
 SM8004F-164BDJ1  
 SM8004F-164BDJ2

SM8004I-164BDJ3



SM8137F



Kunststoff mit M4 Gewinde / plastic with M4 thread

Bestellnummer | Order no.  
 SM8137F-137GL35  
 SM8137F-137GL36

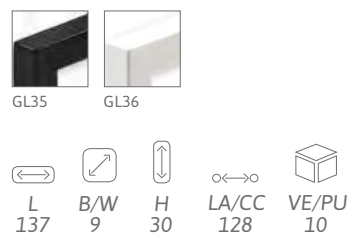

SM8119I



Kunststoff mit M4 Metallmuffe / plastic with M4 metal thread

Bestellnummer | Order no.  
 SM8119I-126SN1MV11  
 SM8119I-126SN9MV11  
 SM8119I-126SN10MV11  
 SM8119I-126SN14MV11  
 SM8119I-126SN16MV11  
 SM8119I-126SN19MV11



SM8118I



Kunststoff mit M4 Metallmuffe / plastic with M4 metal thread

Bestellnummer | Order no.  
 SM8118I-30SN1MV11  
 SM8118I-30SN9MV11  
 SM8118I-30SN10MV11  
 SM8118I-30SN14MV11  
 SM8118I-30SN16MV11  
 SM8118I-30SN19MV11





SM8117I



Kunststoff mit M4 Metallmuffe /  
plastic with M4 metal thread

Bestellnummer | Order no.  
SM8117I-34SN10A83  
SM8117I-34SN11A79  
SM8117I-34SN12A84  
SM8117I-34SN13A80



D	D/S	H	VE/PU
33	13	21	10

SM8116I



Kunststoff mit M4 Metallmuffe /  
plastic with M4 metal thread

Bestellnummer | Order no.  
SM8116I-50SN15MV11  
SM8116I-50SN16MV11  
SM8116I-50SN17MV11  
SM8116I-50SN18MV11  
SM8116I-50SN19MV11



L	B/W	H	D/S	VE/PU
50	48	26	13	10



SM8111



Kunststoff / plastic

Bestellnummer | Order no.  
SM8111-80MV11MT1MV11  
SM8111-80S90



S90



MV11MT1MV11



SM8105I



Kunststoff mit M4 Metallmuffe /  
plastic with M4 metal thread

Bestellnummer | Order no.  
SM8105I-144MV11CP34



MV11CP34

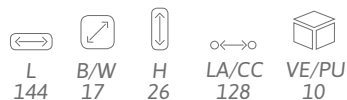

SM8104



Kunststoff / plastic

Bestellnummer | Order no.  
SM8104-40CP34MV2



CP34MV2

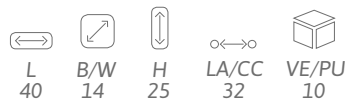

SM8103



Kunststoff / plastic

Bestellnummer | Order no.  
SM8103-136CP34MV11  
SM8103-136MV7MT1



CP34MV11



MV7MT1

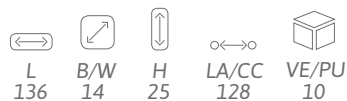

SM8095



Kunststoff / plastic

Bestellnummer | Order no.  
SM8095-148MV11DK193  
SM8095-148MV11MV11



MV11DK193



MV11MV11



SM8094I



Bestellnummer | Order no.  
SM8094I-146MV11T7



MV11T7

L	B/W	H	LA/CC	VE/PU
146	17	23	96/128	10

Kunststoff mit M4 Metallmuffe /  
plastic with M4 metal thread

SM8086



Bestellnummer | Order no.  
SM8086-44MV11DK193  
SM8086-172MV11DK193



MV11DK193

L	B/W	H	LA/CC	VE/PU
45 173	14 14	20 20	32 160	10 10

Kunststoff / plastic



Abbildung: SM8086-172MV11DK193

SM8066I



Kunststoff mit M4 Metallmuffe /  
plastic with M4 metal thread

Bestellnummer | Order no.  
SM8066I-36MV2



MV2

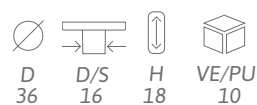

SM8059I



Kunststoff mit M4 Metallmuffe /  
plastic with M4 metal thread

Bestellnummer | Order no.  
SM8059I-176MV11



MV11

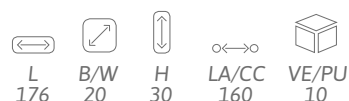

SM8021



Kunststoff / plastic

Bestellnummer | Order no.  
SM8021-130MV2



MV2



SM8014I



Kunststoff mit M4 Metallmuffe /  
plastic with M4 metal thread

Bestellnummer | Order no.  
SM8014I-184MV11



MV11

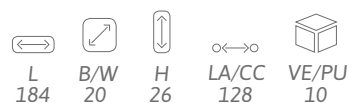

SM8004



Kunststoff / plastic

Bestellnummer | Order no.  
SM8004-164MV2



MV2





Abbildung: SM8014I-184MV11

SM873

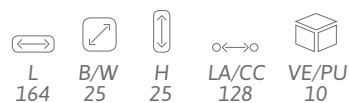

Kunststoff / plastic

Bestellnummer | Order no.  
SM873-34MV7  
SM873-34T7



MV7

T7

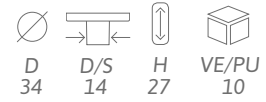

SM083I



Kunststoff mit M4 Metallmuffe /  
plastic with M4 metal thread

Bestellnummer | Order no.  
SM083I-137CP123M  
SM083I-137MV7  
SM083I-137T7



CP123M

MV7

T7

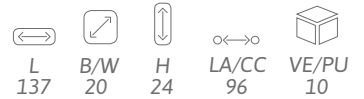

SM447



Kunststoff / plastic

Bestellnummer | Order no.  
SM447-32K10  
SM447-40K10



K10

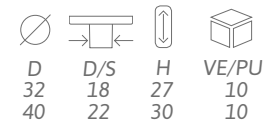

SM440



Kunststoff / plastic

Bestellnummer | Order no.  
SM440-35K12MF1  
SM440-47K12MF1



K12MF1

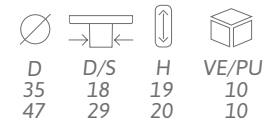

SM065



Kunststoff / plastic

Bestellnummer | Order no.  
SM065-32CP100GMV7  
SM065-32MV2MT1  
SM065-32MV7MV7  
SM065-32MV7T7  
SM065-32T7MV2

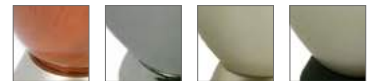

CP100GMV7

MV2MT1

MV7MV7

MV7T7



T7MV2

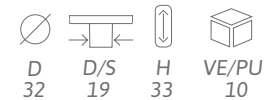





SM050

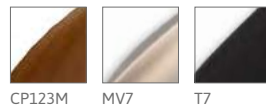

Kunststoff / plastic

Bestellnummer | Order no.  
SM050-97CP123M  
SM050-97MV7  
SM050-97T7



				
L	B/W	H	LA/CC	VE/PU
96	12	25	64	10

SM043



Kunststoff / plastic

Bestellnummer | Order no.  
SM043-90MV2MT1



				
L	B/W	H	LA/CC	VE/PU
89	13	23	64	10

SM009



Kunststoff / plastic

Bestellnummer | Order no.  
SM009-20K10  
SM009-20MT1







			
D	D/S	H	VE/PU
20	17	29	10



Abbildung: SM065-32T7MV2

---

# KUNSTLEDER

---

*Ein besonderes Highlight unserer Kollektion stellen unsere Möbelbeschläge und Hakenleisten aus Kunstleder dar. Kunstleder bietet im Vergleich zu Echtleder den Vorteil, dass es tierfreundlich herstellbar und darüber hinaus sehr pflegeleicht ist.*

*Außerdem handelt es sich um ein robustes und strapazierfähiges Material, das ideal für die tägliche Beanspruchung von Möbelgriffen und Garderobenelementen geeignet ist.*

*Optik und Haptik unserer Kunstleder-Produkte sind so naturgetreu nachgebildet, dass sie kaum von Echtleder zu unterscheiden sind. Auch wird durch die hohe Qualität des Materials und die ergonomische Formgebung ein angenehmer Griff über viele Jahre hinweg gewährleistet.*

*Derzeit wird eine Auswahl aus drei unterschiedlichen Farbtönen und zwei Formen der Ledernarbung geboten.*

*Die Kombination aus Kunstleder und Kunststoff- oder Metall-Elementen macht diese schlichten Griffe und Hakenleisten zu besonderen Hinguckern, die hervorragend zu modernen Wohnbereichen passen.*

---

# IMITATION LEATHER

---

*Particular highlights of this collection are our furniture fittings and hook rails made of artificial leather. This material has several advantages when compared to real leather: no animals are harmed in its production, it is very easy to clean – and artificial leather is robust and durable, making it ideal for the daily use required of furniture and wardrobe elements.*

*The appearance and feel of our artificial leather products are so realistic that it is hard to believe that we don't use real leather. The high-quality material and ergonomic shapes mean that these products will remain pleasing to the touch for many years to come.*

*We currently offer three different colour shades and two leather grains.*

*The combination of artificial leather and plastic or metal elements makes these minimalist handles and hook rails particularly eye-catching. As well as exceptionally well suited to modern living spaces.*





H191



Kunstleder - Druckguss, Metallfuß mit M4 Gewinde /  
imitation leather - die cast, metal base with M4 thread

Bestellnummer | Order no.  
H191-151LS7ZN1  
H191-151LS8ZN1  
H191-183LS7ZN1  
H191-183LS7ZN75  
H191-183LS8ZN1  
H191-215LS7ZN1  
H191-215LS8ZN1



L	B/W	H	LA/CC	VE/PU
152	20	37	128	10
184	20	37	160	10
216	20	37	192	10

LE004



Kunstleder - Druckguss, Metallfuß mit M4 Gewinde /  
imitation leather - die cast, metal base with M4 thread

Bestellnummer | Order no.  
LE004-190LS7ZN78  
LE004-190LS8ZN78



L	B/W	H	LA/CC	VE/PU
190	28	30	160	10

LE005



Kunstleder - Druckguss, Metallfuß mit M4 Gewinde /  
imitation leather - die cast, metal base with M4 thread

Bestellnummer | Order no.  
LE005-75LS7ZN78  
LE005-75LS8ZN78



L	B/W	H	VE/PU
75	28	26	10

H170



Kunstleder - Druckguss, Metallfuß mit M4 Gewinde /  
imitation leather - die cast, metal base with M4 thread

Bestellnummer | Order no.  
H170-150LS7ZN21  
H170-150LS8ZN21  
H170-182LS7ZN21  
H170-182LS8ZN21  
H170-214LS7ZN21  
H170-214LS8ZN21



L	B/W	H	LA/CC	VE/PU
151	20	37	128	10
183	20	37	160	10
215	20	37	192	10

SM8137F



Kunstleder - Kunststoff mit M4 Gewinde /  
imitation leather - plastic with M4 thread

Bestellnummer | Order no.  
SM8137F-137LS7  
SM8137F-137LS8



L	B/W	H	LA/CC	VE/PU
140	11	32	128	10

SM8121I



Bestellnummer | Order no.  
SM8121I-152MT1LS7  
SM8121I-152MV11LS8



L	B/W	H	LA/CC	VE/PU
153	20	21	128	10

Kunstleder - Kunststoff mit M4 Metallmuffe /  
imitation leather - plastic with M4 metal thread

SM8077F



Bestellnummer | Order no.  
SM8077F-56MT1LS7  
SM8077F-56MV11LS8



L	B/W	H	LA/CC	VE/PU
58	18	29	32	10

Kunstleder - Kunststoff mit M4 Gewinde /  
imitation leather - plastic with M4 thread

SM8059I



Bestellnummer | Order no.  
SM8059I-176LS7  
SM8059I-176LS8  
SM8059I-240LS7  
SM8059I-240LS8



L	B/W	H	LA/CC	VE/PU
178 242	22 22	31 34	160 224	10 10

Kunstleder - Kunststoff mit M4 Metallmuffe /  
imitation leather - plastic with M4 metal thread

SM064I



Bestellnummer | Order no.  
SM064I-137LS7  
SM064I-137LS8  
SM064I-137LS9  
SM064I-170LS7  
SM064I-170LS8  
SM064I-170LS9



L	B/W	H	LA/CC	VE/PU
138 171	22 22	27 28	96 128	10 10

Kunstleder - Kunststoff mit M4 Metallmuffe /  
imitation leather - plastic with M4 metal thread



Abbildung: H191-183LS7ZN75

---

# KERAMIK

---

*Keramik – abgeleitet vom altgriechischen Wort Keramos für Ton und die Erzeugnisse daraus – gehört mit zu den ältesten Werkstoffen der Welt. Die Produktion und die Verwendung von Keramik lassen sich weltweit mehrere tausend Jahre zurückverfolgen. Auch heute noch ist Keramik ein beliebtes und angesagtes Material und findet sich in unterschiedlichen Formen in jedem Haushalt wieder.*

*Da die Produkte unseres Keramik-Sortiments temperaturbeständig und äußerst pflegeleicht sind und ihnen eine hohe Luftfeuchtigkeit nichts anhaben kann, eignen sie sich hervorragend für den Einsatz bei Küchen- oder Badezimmermöbeln, aber auch als wirkungsvoll platzierte Details auf Kommoden und Schränken.*

*Ob schlicht in reinem Weiß, in Kombination mit Metall-Elementen oder in nicht ganz alltäglichen Formen – unsere Keramikbeschläge sind in unterschiedlichen Ausführungen erhältlich und lassen sich vielfältig einsetzen.*

*Unsere farbenfrohen, handbemalten Keramikbeschläge verleihen im Handumdrehen jedem Möbelstück das gewisse Etwas, unterstreichen den persönlichen Einrichtungsstil und schaffen durch kraftvolle Farben und wirkungsvolle Details ein einzigartiges Ambiente.*

---

# CERAMIC

---

*The word ceramic comes from the Ancient Greek word Keramos, meaning pottery. It is one of the oldest materials in the world, with a global history of production and usage spanning several thousand years. Today, ceramic remains a popular material and is found in every household in different shapes and forms.*

*The products in our ceramic range are heat resistant, very easy to clean and immune to high levels of humidity. This makes them ideal for kitchen and bathroom furniture, although they are equally at home as decorative details on a chest of drawers or wardrobe.*

*Whether a minimalist white, combined with metal elements or highly sculptural – our ceramic fittings come in many different variations and can be used in manifold ways.*

*Our hand-painted fittings are available in many different colours and quickly turn an item of furniture into something very special. They highlight individual styles and create a unique ambiance through strong colours and stunning details.*



SP81



Keramik - Druckguss mit M4 Metallmuffe/  
ceramic - die cast with M4 metal thread

Bestellnummer | Order no.  
SP81-32PF34ZN29JE17  
SP81-38PF34ZN29JE17



ZN29JE17

D	D/S	H	VE/PU
32	15	30	10
38	15	33	10

SP76



Keramik mit M4 Metallmuffe/  
ceramic with M4 metal thread

Bestellnummer | Order no.  
SP76-29PF25



PF25

L	B/W	H	VE/PU
29	24	25	10

SP69



Keramik mit M4 Metallmuffe/  
ceramic with M4 metal thread

Bestellnummer | Order no.  
SP69-26PF25



PF25

D	D/S	H	VE/PU
26	16	25	10

SP65



Keramik - Druckguss mit M4 Metallmuffe/  
ceramic - die cast with M4 metal thread

Bestellnummer | Order no.  
SP65-34PC6ZN10



PC6ZN10

D	D/S	H	VE/PU
34	*	27	10

\* mit Unterlage: 26  
ohne Unterlage: 14

SP61



Keramik mit M4 Metallmuffe/  
ceramic with M4 metal thread

Bestellnummer | Order no.  
SP61-55



SP

L	B/W	H	D/S	VE/PU
55	34	38	24	10

SP60



Keramik mit M4 Metallmuffe/  
ceramic with M4 metal thread

Bestellnummer | Order no.  
SP60-38



SP



D  
39



D/S  
38



H  
27



VE/PU  
10



SP59 handbemalt / hand painted



Keramik mit M4 Metallmuffe/  
ceramic with M4 metal thread

Bestellnummer | Order no.  
SP59-29PF16  
SP59-29PF32  
SP59-29PF33

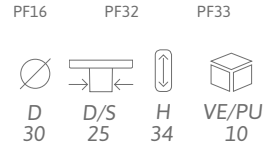

SP58 handbemalt / hand painted



Keramik mit M4 Metallmuffe/  
ceramic with M4 metal thread

Bestellnummer | Order no.  
SP58-38PF15

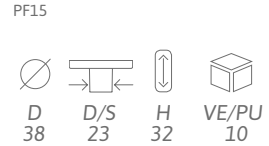

SP57 handbemalt / hand painted



Keramik mit M4 Metallmuffe/  
ceramic with M4 metal thread

Bestellnummer | Order no.  
SP57-28PF14

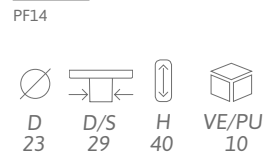

SP56 handbemalt / hand painted



Keramik mit M4 Metallmuffe/  
ceramic with M4 metal thread

Bestellnummer | Order no.  
SP56-35PF13

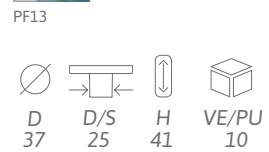

SP55 handbemalt / hand painted



Keramik mit M4 Metallmuffe/  
ceramic with M4 metal thread

Bestellnummer | Order no.  
SP55-35PF12  
SP55-35PF31

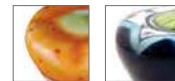



SP54 handbemalt / hand painted



Keramik mit M4 Metallmuffe/  
ceramic with M4 metal thread

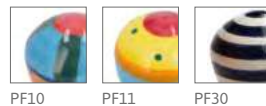

D	D/S	H	VE/PU
29	20	33	10

Bestellnummer | Order no.  
SP54-27PF10  
SP54-27PF11  
SP54-27PF30

SP51



Keramik mit M4 Metallmuffe/  
ceramic with M4 metal thread



D	D/S	H	VE/PU
31	22	28	10
39	27	35	10

Bestellnummer | Order no.  
SP51-32PF17  
SP51-32PF18  
SP51-32PF20  
SP51-39PF17  
SP51-39PF18  
SP51-39PF19  
SP51-39PF20



Abbildung: SP59-29PF32

SP46



Keramik mit M4 Metallmuffe/  
ceramic with M4 metal thread

Bestellnummer | Order no.  
SP46-55



SP

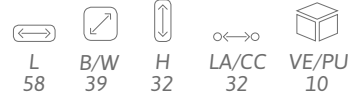

SP44



Keramik mit M4 Metallmuffe/  
ceramic with M4 metal thread

Bestellnummer | Order no.  
SP44-68



SP

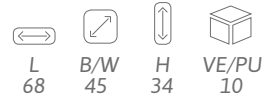

SP43



Keramik mit M4 Metallmuffe/  
ceramic with M4 metal thread

Bestellnummer | Order no.  
SP43-55



SP

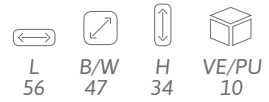

SP36



Keramik - Druckguss, Metallfuß mit M4 Gewinde/  
ceramic - die cast, metal base with M4 thread

Passend zu 1071, 1076 Seite 348, 1072, 1075, Seite 149, 1277 Seite 316, S367 Seite 281  
matching 1071, 1076 page 348, 1072, 1075, page 149, 1277 page 316, S367 page 281

Bestellnummer | Order no.  
SP36-38ZN29



ZN29

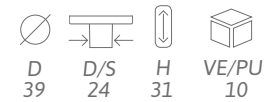

SP8



Keramik - Druckguss, Metallfuß mit M4 Gewinde/  
ceramic - die cast, metal base with M4 thread

Bestellnummer | Order no.  
SP8-35MS1  
SP8-35MS3



MS1



MS3

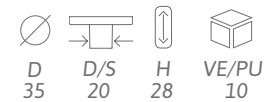

SP7



Keramik mit M4 Metallmuffe/  
ceramic with M4 metal thread



SP

Bestellnummer | Order no.  
SP7-32  
SP7-39





 D	 D/S	 H	 VE/PU
31	25	28	10
39	28	32	10



Abbildung: SP36-38ZN29

SP6



Keramik mit M4 Metallmuffe/  
ceramic with M4 metal thread

Bestellnummer | Order no.  
SP6-33  
SP6-33PD5  
SP6-38  
SP6-38PD5



D	D/S	H	VE/PU
33	16	25	10
37	19	28	10

SP5



Keramik - Druckguss, Metallfuß mit M4 Gewinde/  
ceramic - die cast, metal base with M4 thread

Bestellnummer | Order no.  
SP5-25MS1  
SP5-25MS3  
SP5-30MS1  
SP5-30MS3  
SP5-35MS1  
SP5-35MS3



D	D/S	H	VE/PU
25	14	31	10
31	14	30	10
35	14	30	10

SP1



Keramik mit M4 Metallmuffe/  
ceramic with M4 metal thread

Bestellnummer | Order no.  
SP1-25  
SP1-25PD1  
SP1-25PD3  
SP1-33  
SP1-33PD1  
SP1-38  
SP1-38PD1



D	D/S	H	VE/PU
26	12	23	10
32	14	25	10
38	16	26	10

TR01



Terrakotta mit M4 Metallmuffe/  
terracotta with M4 metal thread

Bestellnummer | Order no.  
TR01-37TK2



D	D/S	H	VE/PU
37	16	27	10

TR02



Terrakotta mit M4 Metallmuffe/  
terracotta with M4 metal thread

Bestellnummer | Order no.  
TR02-35TK2



D	D/S	H	VE/PU
35	16	25	10



Abbildung: SPI-38

---

# HOLZ

---

*Holz wird seit Menschengedenken als beliebter Baustoff und zur Energiegewinnung verwendet, zählt in Österreich zu den wichtigsten Rohstoffen und bietet als Werkstoff zahlreiche Vorteile.*

*So gilt Holz bei der richtigen Waldbewirtschaftung als nachhaltiges, umweltfreundliches und vielseitig einsetzbares Material. Nachhaltigkeit und Umweltschutz werden auch bei SIRO seit Langem großgeschrieben. Unser FSC-zertifiziertes Unternehmen SIRO Bielsko verwendet bereits seit über 20 Jahren ausschließlich Holz aus garantiert nachhaltiger Forstwirtschaft.*

*Vieles spricht für Möbel und Accessoires aus Echtholz. Sie verleihen einem Raum eine gewisse Behaglichkeit und Wärme, sind für alle Wohnbereiche geeignet und regulieren das Raumklima auf natürliche Weise, indem sie Feuchtigkeit aus der Luft aufnehmen und bei Bedarf wieder abgeben.*

*Unsere Holzgriffe und -knöpfe sind die perfekte Ergänzung für Vollholzmöbel. Sie sorgen im wahrsten Sinne des Wortes für einen natürlichen Touch, fühlen sich angenehm an und passen zu jedem Stil, ob rustikal oder modern. Sie können sowohl bei traditionellen Möbeln verwendet werden als auch in Kombination mit modernen Elementen und unterschiedlichen Materialien.*

*Durch die abwechslungsreichen Ausführungen und eine reiche Auswahl an verschiedenen Farben können unsere Holzbeschläge perfekt auf die bestehende Einrichtung abgestimmt werden.*

---

# WOOD

---

*Wood has been a popular building material and fuel source since time immemorial. It is one of Austria's most important raw materials and has numerous advantages.*

*When forests are correctly managed, wood is a sustainable, environmentally friendly and versatile material. SIRO has long understood the importance of sustainability and environmental protection. For the past 20 years, our FSC-certified company SIRO Bielsko has exclusively used wood from sustainably managed forests. There are many reasons to choose furniture and accessories made of solid wood. As a material, it brings a sense of comfort and warmth to a room, is suitable for all living areas and naturally regulates the indoor climate by absorbing humidity and releasing it again as required.*

*Our wooden handles and knobs add the perfect finishing touch to solid wood furniture. They bring something of the outdoors into a living space, are pleasant to the touch and complement every style, whether rustic or modern. They can be added to traditional furniture or combined with modern elements and different materials.*

*Our many designs and wide range of shades mean that you will always find the perfect wooden fittings for your interior.*



G18



Holz mit M4 Metallmuffe / wood with M4 metal thread

Bestellnummer | Order no.  
 G18-110HZ1  
 G18-110HZ2  
 G18-110HZ11  
 G18-110HZ16

HZ1 HZ2 HZ11 HZ16

L 110  
 B/W 50  
 H 20  
 LA/CC 64  
 VE/PU 10

G17



Holz mit M4 Metallmuffe / wood with M4 metal thread

Bestellnummer | Order no.  
 G17-110HZ1  
 G17-110HZ6  
 G17-110HZ16

HZ1 HZ6 HZ16

L 110  
 B/W 40  
 H 19  
 LA/CC 64  
 VE/PU 10

S60



Holz / wood

Bestellnummer | Order no.  
 S60-110HZ14

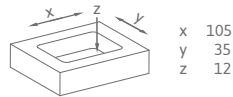

HZ14

L 110  
 B/W 40  
 H 16  
 VE/PU 10

L32



Holz mit M4 Metallmuffe / wood with M4 metal thread

Bestellnummer | Order no.  
 L32-34HZ6

HZ6

D 35  
 D/S 26  
 H 24  
 VE/PU 10

S669



Holz mit M4 Metallmuffe / wood with M4 metal thread

Bestellnummer | Order no.  
 S669-116HZ34  
 S669-148HZ34

HZ34

L 116 / 148  
 B/W 12  
 H 30  
 LA/CC 96 / 128  
 VE/PU 10





S657



Holz mit M4 Metallmuffe / wood with M4 metal thread

Bestellnummer | Order no.  
S657-30HZ18  
S657-30HZ63  
S657-30HZ64



D	D/S	H	VE/PU
30	14	14	10

S656



Holz mit M4 Metallmuffe / wood with M4 metal thread

Bestellnummer | Order no.  
S656-45HZ21HZ62



HZ21HZ62

D	D/S	H	VE/PU
45	14	24	10

S655



Holz mit M4 Metallmuffe / wood with M4 metal thread

Bestellnummer | Order no.  
S655-48HZS224



HZS224

D	D/S	H	VE/PU
48	25	26	10

S653A



Holz mit 3 mm Bohrung / wood with drilling 3 mm

Bestellnummer | Order no.  
S653A-15HZ34HZ61  
S653A-96HZ34HZ61  
S653A-128HZ34HZ61



HZ34HZ61

L	B/W	H	LA/CC	VE/PU
15	12	25	0	10
96	12	25	64	10
128	12	25	96	10

S652A



Holz mit 3 mm Bohrung / wood with drilling 3 mm

Bestellnummer | Order no.  
S652A-40HZ34HZ55  
S652A-96HZ34HZ55



HZ34HZ55

L	B/W	H	LA/CC	VE/PU
40	15	20	16	10
96	15	20	64	10

S647A



Bestellnummer | Order no.  
S647A-96HZ34HZ55



HZ34HZ55



L  
96



B/W  
28



H  
21



LA/CC  
64



VE/PU  
10

Holz mit 3 mm Bohrung /  
wood with drilling 3 mm



Abbildung: S653A-128HZ34HZ61, S653A-96HZ34HZ61, S653A-15HZ34HZ61, S657-30HZ18, S652A-96HZ34HZ55, S652A-40HZ34HZ55, S647A-96HZ34HZ55, S655-48HZS224

S638



Holz mit M4 Metallmuffe /  
wood with M4 metal thread

Bestellnummer | Order no.  
S638-14HZ18  
S638-18HZ6  
S638-18HZ18



HZ6

HZ18

D	D/S	H	VE/PU
14	14	26	10
18	18	30	10

S637A



Holz mit 3 mm Bohrung /  
wood with drilling 3 mm

Bestellnummer | Order no.  
S637A-20HZ6



HZ6

D	D/S	H	VE/PU
20	13	40	10

S424



Holz mit M4 Metallmuffe /  
wood with M4 metal thread

Bestellnummer | Order no.  
S424-34HZ16



HZ16

D	D/S	H	VE/PU
34	30	32	10

S423



Holz mit M4 Metallmuffe /  
wood with M4 metal thread

Bestellnummer | Order no.  
S423-35HZ5  
S423-35HZ16



HZ5

HZ16

D	D/S	H	VE/PU
35	16	25	10

S423A



Holz mit 3 mm Bohrung /  
wood with drilling 3 mm

Bestellnummer | Order no.  
S423A-35HZ11



HZ11

D	D/S	H	VE/PU
35	16	25	10

S367



Bestellnummer | Order no.  
 S367-30HZ16ZN29  
 S367-35HZ5ZN29  
 S367-44HZ5ZN29

Holz - Druckguss, Metallfuß mit M4 Gewinde /  
 wood - die cast, metal base with M4 thread

Passend zu 1071, 1076 Seite 348, 1072, 1075 Seite 149, 1277 Seite 316, SP36 Seite 270  
 matching 1071, 1076 page 348, 1072, 1075 page 149, 1277 page 316, SP36 page 270



HZ5ZN29 HZ16ZN29

D	D/S	H	VE/PU
30	21	26	10
35	26	27	10
44	35	29	10

S358



Bestellnummer | Order no.  
 S358-30HZ11  
 S358-30HZ17  
 S358-30HZ18  
 S358-30HZ34  
 S358-39HZ17  
 S358-39HZ18

Holz mit M4 Metallmuffe /  
 wood with M4 metal thread



HZ11 HZ17 HZ18 HZ34

D	D/S	H	VE/PU
30	25	31	10
39	28	35	10

S358A



Bestellnummer | Order no.  
 S358A-30HZ18  
 S358A-30HZ34

Holz mit 3 mm Bohrung /  
 wood with drilling 3 mm



HZ18 HZ34

D	D/S	H	VE/PU
30	25	31	10
39	28	35	10



Abbildung: S367-44HZ5ZN29

S351



Holz - Druckguss / wood - die cast

Bestellnummer | Order no.  
 S351-133HZ18ZN4  
 S351-133HZ34ZN2  
 S351-165HZ17ZN4  
 S351-165HZ18ZN2  
 S351-165HZ18ZN4  
 S351-165HZ34ZN2

HZ17ZN4	HZ18ZN2	HZ18ZN4	HZ34ZN2
L	B/W	H	LA/CC
133	14	32	96
165	15	32	128
VE/PU	VE/PU		
10	10		

S301



Holz mit M4 Metallmuffe / wood with M4 metal thread

Bestellnummer | Order no.  
 S301-75HZ16  
 S301-75HZ35  
 S301-107HZ5  
 S301-107HZ16  
 S301-107HZ17  
 S301-107HZ18  
 S301-107HZ34  
 S301-107HZ35

HZ5	HZ16	HZ17	HZ18
HZ34	HZ35		
L	B/W	H	LA/CC
76	14	29	64
108	14	29	96
VE/PU	VE/PU		
10	10		

S300



Holz mit M4 Metallmuffe / wood with M4 metal thread

Bestellnummer | Order no.  
 S300-30HZ5  
 S300-30HZ16  
 S300-30HZ17  
 S300-30HZ35  
 S300-35HZ5  
 S300-35HZ16  
 S300-35HZ35  
 S300-40HZ5

HZ5	HZ16	HZ17	HZ35
D	D/S	H	VE/PU
30	20	25	10
35	23	26	10
40	28	30	10

S251



Holz mit M4 Metallmuffe / wood with M4 metal thread

Bestellnummer | Order no.  
 S251-133HZ11  
 S251-133HZ16  
 S251-170HZ1  
 S251-170HZ6  
 S251-170HZ11  
 S251-170HZ16

HZ1	HZ6	HZ11	HZ16
L	B/W	H	LA/CC
133	13	29	96
170	13	34	128
VE/PU	VE/PU		
10	10		

S251A



Holz mit 3 mm Bohrung / wood with drilling 3 mm

Bestellnummer | Order no.  
 S251A-133HZ6

HZ6			
L	B/W	H	LA/CC
133	13	29	96
VE/PU	VE/PU		
10	10		

S231



Holz mit M4 Metallmuffe/  
wood with M4 metal thread

Bestellnummer | Order no.  
S231-120HZ6  
S231-120HZ14



HZ6

HZ14

L 120	B/W 17	H 26	LA/CC 96	VE/PU 10



S229



Holz mit M4 Metallmuffe /  
wood with M4 metal thread

Bestellnummer | Order no.  
S229-35HZ16  
S229-35HZ18



HZ16

HZ18

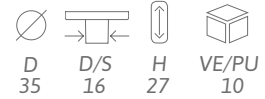

S217



Holz - Druckguss mit M4 Metallmuffe /  
wood - die cast with M4 metal thread

Bestellnummer | Order no.  
S217-16HZ17ZN1



HZ17ZN1

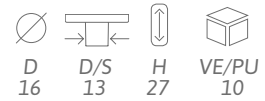

S177



Holz mit M4 Metallmuffe /  
wood with M4 metal thread

Bestellnummer | Order no.  
S177-35HZ16



HZ16

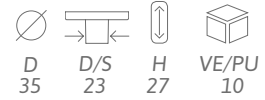

S157



Holz mit M4 Metallmuffe /  
wood with M4 metal thread

Bestellnummer | Order no.  
S157-15HZ6  
S157-15HZ14  
S157-15HZ16



HZ6

HZ14

HZ16

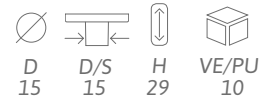

S120



Holz mit M4 Metallmuffe /  
wood with M4 metal thread

Bestellnummer | Order no.  
S120-120HZ14  
S120-120HZ16  
S120-120HZ17



HZ14

HZ16

HZ17

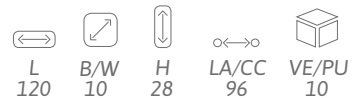



S113



Holz mit M4 Metallmuffe / wood with M4 metal thread

Bestellnummer | Order no.  
 S113-76HZ6  
 S113-76HZ11  
 S113-108HZ5  
 S113-108HZ6  
 S113-108HZ11



L	B/W	H	LA/CC	VE/PU
76	13	30	64	10
108	13	30	96	10

S87



Holz mit M4 Metallmuffe / wood with M4 metal thread

Bestellnummer | Order no.  
 S87-30HZ2  
 S87-30HZ4  
 S87-30HZ5  
 S87-30HZ6  
 S87-30HZ11  
 S87-30HZ13  
 S87-30HZ14  
 S87-30HZ16  
 S87-30HZ17  
 S87-30HZ18  
 S87-30HZ33  
 S87-35HZ1  
 S87-35HZ2  
 S87-35HZ5  
 S87-35HZ6  
 S87-35HZ11  
 S87-35HZ13  
 S87-35HZ14  
 S87-35HZ16  
 S87-35HZ17  
 S87-35HZ18  
 S87-35HZ33  
 S87-44HZ1  
 S87-44HZ5  
 S87-44HZ6  
 S87-44HZ11  
 S87-44HZ14  
 S87-44HZ16  
 S87-44HZ17  
 S87-44HZ33



D	D/S	H	VE/PU
30	21	26	10
35	26	27	10
44	35	28	10

S87A



Holz mit 3 mm Bohrung / wood with drilling 3 mm

Bestellnummer | Order no.  
 S87A-30HZ5  
 S87A-30HZ11  
 S87A-30HZ17  
 S87A-35HZ5  
 S87A-35HZ11  
 S87A-35HZ17  
 S87A-35HZ21  
 S87A-44HZ5  
 S87A-44HZ11  
 S87A-44HZ17  
 S87A-44HZ21



D	D/S	H	VE/PU
30	21	26	10
35	26	27	10
44	35	28	10

S87A



Holz mit 3 mm Bohrung / wood with drilling 3 mm

Bestellnummer | Order no.  
 S87A-30HZ6V4\*



D	D/S	H	VE/PU
30	21	26	5

\* Bestellnr. für 4 Stück / order no. for 4 pcs.  
 VE / MOQ : 5 = 20 Stück / pieces

S70



Holz mit M4 Metallmuffe / wood with M4 metal thread

Bestellnummer | Order no.

- S70-30HZ1
- S70-30HZ2
- S70-30HZ6
- S70-30HZ11
- S70-30HZ14
- S70-30HZ16
- S70-35HZ1
- S70-35HZ2
- S70-35HZ6
- S70-35HZ11
- S70-35HZ13
- S70-35HZ14
- S70-35HZ16
- S70-35HZ17
- S70-44HZ1
- S70-44HZ2
- S70-44HZ6
- S70-44HZ14
- S70-44HZ16



D	D/S	H	VE/PU
30	21	27	10
35	26	29	10
44	35	29	10

S70A



Holz mit 3 mm Bohrung / wood with drilling 3 mm

Bestellnummer | Order no.

- S70A-30HZ5
- S70A-35HZ5
- S70A-35HZ17
- S70A-44HZ5



D	D/S	H	VE/PU
30	21	27	10
35	26	29	10
44	35	29	10

S50



Holz mit M4 Metallmuffe / wood with M4 metal thread

Bestellnummer | Order no.

- S50-80HZ6
- S50-80HZ16
- S50-112HZ1
- S50-112HZ6
- S50-112HZ14
- S50-112HZ16
- S50-112HZ37



L	B/W	H	LA/CC	VE/PU
80	16	32	64	10
112	16	32	96	10

S50A



Holz mit 3 mm Bohrung / wood with drilling 3 mm

Bestellnummer | Order no.

- S50A-80HZ1
- S50A-112HZ5
- S50A-112HZ17



L	B/W	H	LA/CC	VE/PU
80	16	32	64	10
112	16	32	96	10

S30



Holz mit M4 Metallmuffe /  
wood with M4 metal thread

Bestellnummer | Order no.  
S30-112HZ1  
S30-112HZ5  
S30-112HZ6  
S30-112HZ11  
S30-112HZ14  
S30-112HZ16  
S30-112HZ18



HZ1 HZ5 HZ6 HZ11



HZ14 HZ16 HZ18

L	B/W	H	LA/CC	VE/PU
112	17	30	96	10

S30A



Holz mit 3 mm Bohrung /  
wood with drilling 3 mm

Bestellnummer | Order no.  
S30A-112HZ5



HZ5

L	B/W	H	LA/CC	VE/PU
112	17	30	96	10



---

# HAKEN

---

*Bei der Produktion unserer Haken und Zierhaken greifen wir auf bewährte Materialien – Metall, Edelstahl, Kunststoff und Holz – zurück und kombinieren diese auch gerne miteinander.*

*Die Haken eignen sich für den Einsatz in allen Wohnbereichen, von der Garderobe über die Küche bis hin zum Badezimmer und können je nach Wunsch direkt an der Wand oder als Ergänzung an bestehenden Möbelstücken montiert werden. Die erprobte Qualität des Materials und die sorgfältige Herstellung garantieren eine lange Haltbarkeit auch bei starker Beanspruchung.*

*Durch den Materialmix und die vielfältigen Ausführungen in Form und Farbe passen unsere Haken zu jedem Einrichtungsstil. Je nach persönlichem Geschmack können sie als schlichte und dezente Alltagshelfer, aber auch als bewusst eingesetzte Designelemente dienen.*

*Die ansprechenden Details wie handbemalte Oberflächen oder rustikale Verzierungen verstärken das Flair von traditionell eingerichteten Räumen, zeitlose Ausführungen in Edelstahl bieten die optimale Ergänzung für ein modernes Umfeld.*

---

# HOOKS

---

*When manufacturing both our plain and decorative hooks, we make use of tried-and-tested materials – metal, stainless steel, plastic and wood – also combining them with one another.*

*The hooks are suitable for all living areas, from the hallway, to the kitchen or the bathroom. They can be mounted directly onto the wall or added to existing items of furniture. The proven quality of the material and our meticulous production process mean that these products will last for many years – even used day in, day out.*

*The combination of materials and the many different colours and shapes of our designs ensure that you will find hooks to suit any interior – whether you are looking for subtle, everyday products or striking design features.*

*Beautiful details such as hand-painted surfaces or rustic embellishments highlight the flair of traditional rooms. And timeless design classics in stainless steel make for perfect additions to a modern living environment.*

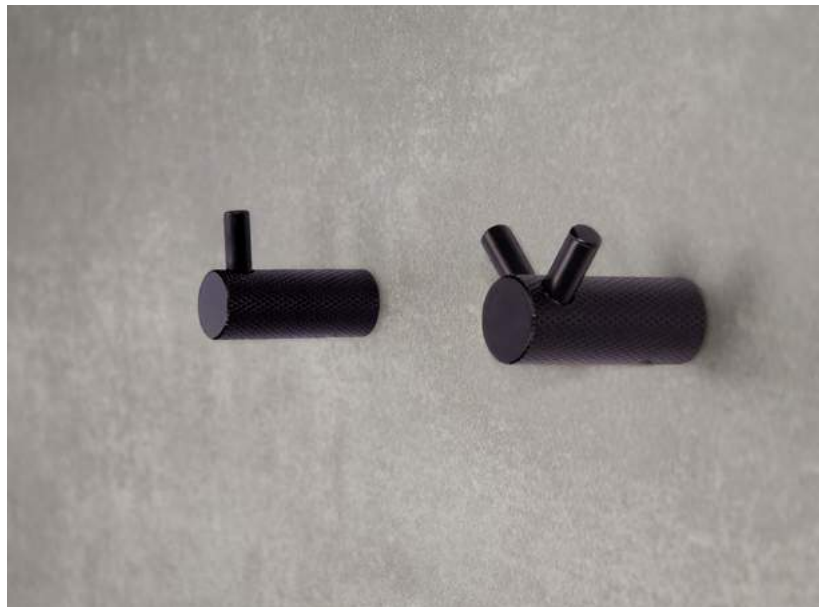

2463



Bestellnummer | Order no.  
2463/PB12  
2463/ZN27

Aluminium / aluminium

Passend zu 2457, 2464 Seite 42, 2459 Seite 386  
matching 2457, 2464 page 42, 2459 page 386

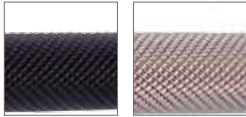

PB12

ZN27

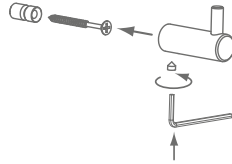

L 26	B/W 34	H 40	VE/PU 5



2462



Bestellnummer | Order no.  
2462/PB12  
2462/ZN27

Aluminium / aluminium

Passend zu 2457, 2464 Seite 42, 2459 Seite 386  
matching 2457, 2464 page 42, 2459 page 386

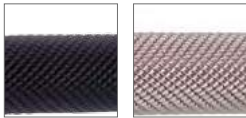

PB12

ZN27

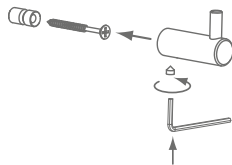

L 30	B/W 16	H 40	VE/PU 5

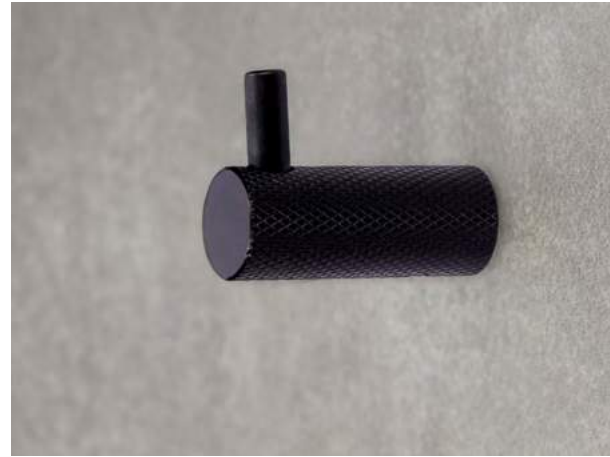

2453



Bestellnummer | Order no.  
2453/PB1  
2453/PB12

Stahl / steel

Passend zu 2452 Seite 360  
matching 2452 page 360



PB1

PB12

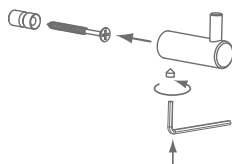

L 28	B/W 14	H 40	VE/PU 5



LOCHABSTAND | CENTER TO CENTER

VERPACKUNGSEINHEIT | PACKING UNIT

DURCHMESSER | DIAMETER

LÄNGE (OBEN - UNTEN) | LENGTH (UP - DOWN)

BREITE | WIDTH

HÖHE (ABSTAND ZUR WAND) | HEIGHT (DISTANCE TO WALL)



Abbildung: 2463/PB12, 2462/PB12

2435



Bestellnummer | Order no.  
2435/PB12  
2435/ZN1  
2435/ZN21  
2435/ZN75

Druckguss / die cast



PB12

ZN1

ZN21

ZN75

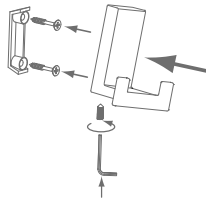

L 52	B/W 43	H 31	LA/CC 24	VE/PU 5



2434



Bestellnummer | Order no.  
2434/PB12  
2434/ZN21  
2434/ZN75

Druckguss / die cast



PB12

ZN21

ZN75

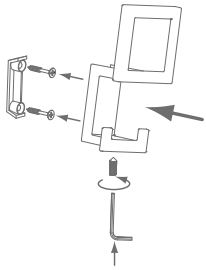

L 101	B/W 52	H 43	LA/CC 24	VE/PU 5



2377



Bestellnummer | Order no.  
2377/ZN1  
2377/ZN21

Druckguss / die cast

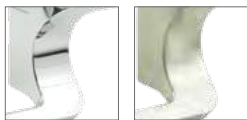

ZN1

ZN21

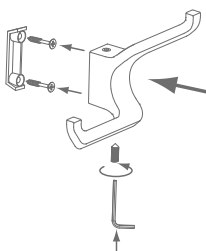

L 63	B/W 108	H 37	LA/CC 16	VE/PU 5



LOCHABSTAND | CENTER TO CENTER

VERPACKUNGSEINHEIT | PACKING UNIT

DURCHMESSER | DIAMETER

LÄNGE (OBEN - UNTEN) | LENGTH (UP - DOWN)

BREITE | WIDTH

HÖHE (ABSTAND ZUR WAND) | HEIGHT (DISTANCE TO WALL)





Abbildung: 2435/ZN21, 2434/ZN21

2433



Bestellnummer | Order no.  
 2433/PB12  
 2433/ZN1  
 2433/ZN21  
 2433/ZN75  
 2433/ZN79  
 2433/ZN83



Druckguss / die cast

PB12 ZN1 ZN21 ZN75 ZN79 ZN83

L 81 B/W 15 H 40 LA/CC 32 VE/PU 5

2432



Bestellnummer | Order no.  
 2432/PB12  
 2432/ZN1  
 2432/ZN21  
 2432/ZN75  
 2432/ZN79  
 2432/ZN83



Druckguss / die cast

PB12 ZN1 ZN21 ZN75 ZN79 ZN83

L 150 B/W 15 H 71 LA/CC 32 VE/PU 5

2355

Saughaken / suction hook



Bestellnummer | Order no.  
 2355/ZN1V1B  
 2355/ZN21V1B



Druckguss / die cast

ZN1 ZN21

L 50 B/W 50 H 30 VE/PU 5

○↔○ LOCHABSTAND | CENTER TO CENTER

☐ VERPACKUNGSEINHEIT | PACKING UNIT

∅ DURCHMESSER | DIAMETER

↕ LÄNGE (OBEN - UNTEN) | LENGTH (UP - DOWN)

↔ BREITE | WIDTH

∩ HÖHE (ABSTAND ZUR WAND) | HEIGHT (DISTANCE TO WALL)



Abbildung: 2433/ZN1, 2433/ZN21, 2433/ZN75, 2433/ZN79, 2433/ZN83, 2432/ZN1, 2432/ZN21, 2432/ZN75, 2432/ZN79, 2432/ZN83

2295



Druckguss - Kunststoff / die cast - plastic

Bestellnummer | Order no.  
2295-121ZN1A4  
2295-121ZN21E2



L	B/W	H	LA/CC	VE/PU
122	19	26	40	5

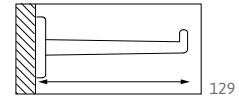

2227



Druckguss / die cast

Passend zu 2231 Seite 66  
matching 2231 page 66

Bestellnummer | Order no.  
2227-93PB12  
2227-93ZN1  
2227-93ZN21  
2227-177PB12  
2227-177ZN1  
2227-177ZN21



L	B/W	H	LA/CC	VE/PU
<sup>01</sup> 93	13	19	0	5
<sup>02</sup> 177	13	19	64	5

	<sup>01</sup>	<sup>02</sup>
x	90	174
y	10	10
z	13	13

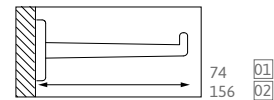

2236F

Gardarobenelement / wardrobe element



Edelstahl mit M4 x 10 mm Gewinde /  
stainless steel with M4 x 10 mm thread

Bestellnummer | Order no.  
2236F-251N1V1K\*

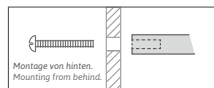

\* Bestellnr. für 1 Stück / order no. for 1 pcs.  
VE / MOQ : 1 = 1 Stück / pieces



L	B/W	H	VE/PU
251	12	60	1

2235F



Edelstahl mit M4 x 10 mm Gewinde /  
stainless steel with M4 x 10 mm thread

Bestellnummer | Order no.  
2235F/N1V3B\*

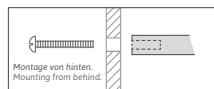

\* Bestellnr. für 3 Stück / order no. for 3 pcs.  
VE / MOQ : 5 = 15 Stück / pieces



L	B/W	H	VE/PU
25	10	60	5

2234

Kleiderlüfter / clothes airer



Aluminium - Kunststoff / aluminium - plastic

Bestellnummer | Order no.  
2234-235AL2A3V1K

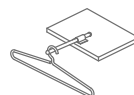

L	B/W	H	LA/CC	VE/PU
235	44	18	27x33	5

LOCHABSTAND | CENTER TO CENTER

VERPACKUNGSEINHEIT | PACKING UNIT

DURCHMESSER | DIAMETER

LÄNGE (OBEN - UNTEN) | LENGTH (UP - DOWN)

BREITE | WIDTH

HÖHE (ABSTAND ZUR WAND) | HEIGHT (DISTANCE TO WALL)



Abbildung: 2236F-251N1V1K,  
2235F/N1V3B



Abbildung: 2227-177ZN1, 2227-93ZN1

2363 Schrankhaken / cabinet hook



Stahl - Kunststoff / steel - plastic

Bestellnummer | Order no.  
2363-192PB21A141V1K

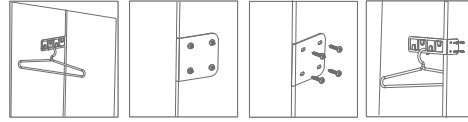

PB21A141

L	B/W	H	LA/CC	VE/PU
55	62	192	32 x 32	5

2337



Edelstahl / stainless steel

Bestellnummer | Order no.  
2337/N1V1KF



N1

L	B/W	H	LA/CC	VE/PU
210	60	123	46	1

2336



Edelstahl / stainless steel

Bestellnummer | Order no.  
2336/N1V1KF



N1

L	B/W	H	LA/CC	VE/PU
133	51	173	34	1

1142

Kleiderlüfter / clothes airer



Druckguss / die cast

Bestellnummer | Order no.  
1142-290PB1  
1142-290PB15



PB1

PB15

L	B/W	H	LA/CC	VE/PU
307	31	59	89	5

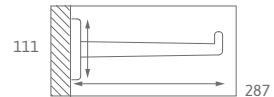

1141

Kleiderlüfter / clothes airer



Druckguss / die cast

Bestellnummer | Order no.  
1141-330PB1  
1141-330PB15  
1141-330PB16  
1141-330ZN10



PB1

PB15

PB16

ZN10

L	B/W	H	LA/CC	VE/PU
380	29	41	87	5



606 Kleiderlüfter / clothes airer



Druckguss / die cast

Bestellnummer | Order no.  
606-130ZN4  
606-130ZN5



L 162	B/W 52	H 28	LA/CC 60	VE/PU 5

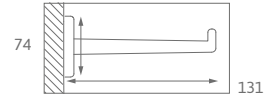

605 Kleiderlüfter / clothes airer



Druckguss / die cast

Bestellnummer | Order no.  
605-210PB1  
605-210ZN1  
605-210ZN5  
605-210ZN10



L 233	B/W 41	H 26	LA/CC 64	VE/PU 5

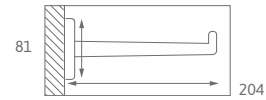

H200 Kleiderlüfter / clothes airer



Kunststoff / plastic

Bestellnummer | Order no.  
H200-280A3  
H200-280A4



L 315	B/W 26	H 64	LA/CC 74	VE/PU 5



Abbildung: 2363-192PB21A141V1K

2326

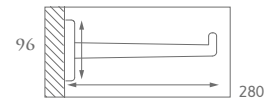

Druckguss / die cast

Bestellnummer | Order no.  
 2326/PB1  
 2326/PB12  
 2326/PB21  
 2326/ZN1  
 2326/ZN5  
 2326/ZN21  
 2326/ZN75  
 2326/ZN79

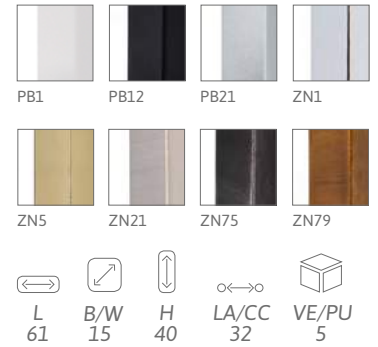
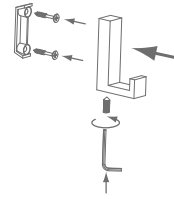

2325



Druckguss / die cast

Bestellnummer | Order no.  
 2325/PB1  
 2325/PB12  
 2325/PB21  
 2325/ZN1  
 2325/ZN5  
 2325/ZN21  
 2325/ZN75  
 2325/ZN79

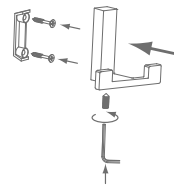

2324



Druckguss / die cast

Bestellnummer | Order no.  
 2324/PB1  
 2324/PB12  
 2324/PB21  
 2324/ZN1  
 2324/ZN5  
 2324/ZN21  
 2324/ZN75  
 2324/ZN79

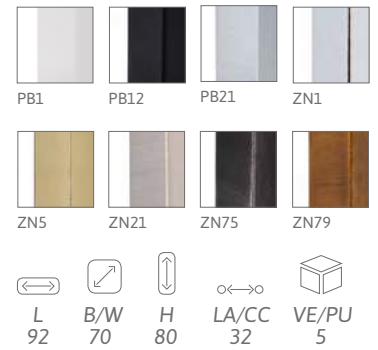
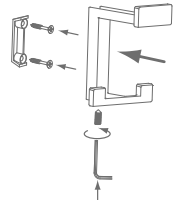

2314



Aluminium / aluminium

Bestellnummer | Order no.  
 2314/PB1  
 2314/PB12  
 2314/PB21

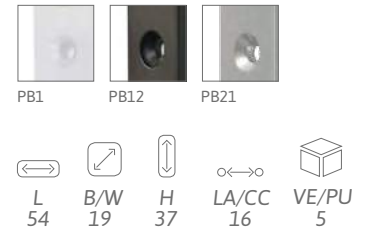

2313



Aluminium / aluminium

Bestellnummer | Order no.  
 2313/PB1  
 2313/PB12  
 2313/PB21

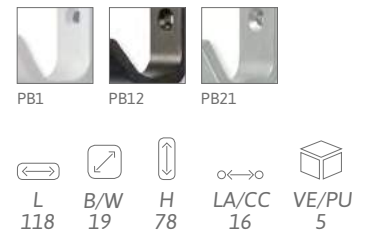



2287



Druckguss / die cast

Bestellnummer | Order no.  
2287/ZN1  
2287/ZN21

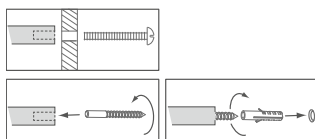

ZN1 ZN21  
D 18 H 53 VE/PU 10

2214



Druckguss / die cast

Bestellnummer | Order no.  
2214/ZN29  
2214/ZN58



ZN29 ZN58  
L 57 B/W 60 H 28 LA/CC 32 VE/PU 5

Passend zu 2150, 2162, 2163 Seite 72  
matching 2150, 2162, 2163 page 72

2213



Druckguss / die cast

Bestellnummer | Order no.  
2213/ZN29  
2213/ZN58



ZN29 ZN58  
L 148 B/W 60 H 66 LA/CC 32 VE/PU 5

Passend zu 2150, 2162, 2163 Seite 72  
matching 2150, 2162, 2163 page 72



Abbildung: 2326/ZN75, 2325/ZN75, 2324/ZN75

2177



Stahl / steel

Bestellnummer | Order no.  
2177/ZN1  
2177/ZN4



L 41  
 B/W 30  
 H 15  
 VE/PU 10

Passend zu 2178 Seite 354, 2144 Seite 379, 2179, 2180 Seite 378  
matching 2178 page 354, 2144 page 379, 2179, 2180 page 378

2107



Druckguss / die cast

Bestellnummer | Order no.  
2107-40ZN1  
2107-40ZN2  
2107-40ZN4  
2107-40ZN5



D 16  
 H 40  
 VE/PU 5

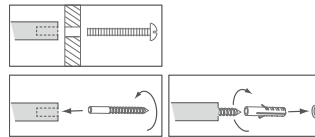

2081



Stahl / steel

Bestellnummer | Order no.  
2081/ZN1V3E\*



L 48  
 B/W 9  
 H 32  
 VE/PU 5

Passend zu 2323 Seite 360, 2378 Seite 378  
matching 2323 page 360, 2378 page 378

\* Bestellnr. für 3 Stück / order no. for 3 pcs.  
VE / MOQ : 5 = 15 Stück / pieces

2081DM



Stahl / steel

Bestellnummer | Order no.  
2081DM/ZN1V3E\*

zur Deckenmontage /  
for mounting on the ceiling

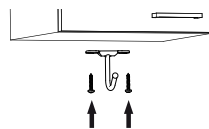

L 36  
 B/W 52  
 H 51  
 LA/CC 41  
 VE/PU 5

Passend zu 2323 Seite 360, 2378 Seite 378  
matching 2323 page 360, 2378 page 378

\* Bestellnr. für 3 Stück / order no. for 3 pcs.  
VE / MOQ : 5 = 15 Stück / pieces

2052



Stahl - Kunststoff / steel - plastic

Bestellnummer | Order no.  
2052/SN10PB21A105  
2052/SN19PB21A105



L 100  
 B/W 88  
 H 30  
 VE/PU 5

2051



Stahl - Kunststoff / steel - plastic

Bestellnummer | Order no.  
 2051/SN10PB21A105  
 2051/SN15PB21A105  
 2051/SN16PB21A105  
 2051/SN19PB21A105



SN10PB21 A105   SN15PB21 A105   SN16PB21 A105   SN19PB21 A105



L 97   B/W 71   H 30   VE/PU 5

2050



Stahl - Kunststoff / steel - plastic

Bestellnummer | Order no.  
 2050/SN10PB21A105  
 2050/SN15PB21A105  
 2050/SN19PB21A105



SN10PB21 A105   SN15PB21 A105   SN19PB21 A105



L 100   B/W 77   H 30   VE/PU 5



Abbildung: 2052/SN10PB21A105

2020



Druckguss / die cast

Passend zu 2016, 2032, 2033 Seite 84  
matching 2016, 2032, 2033 page 84

Bestellnummer | Order no.  
2020/ZN29  
2020/ZN31

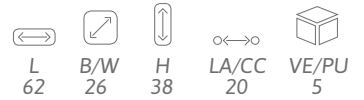

2019



Druckguss / die cast

Passend zu 2016, 2032, 2033 Seite 84  
matching 2016, 2032, 2033 page 84

Bestellnummer | Order no.  
2019/ZN29  
2019/ZN31

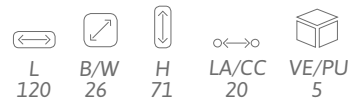

1982



Druckguss - Kunststoff / die cast - plastic

Passend zu 1896, 1897, 1898 Seite 96  
matching 1896, 1897, 1898 page 96

Bestellnummer | Order no.  
1982/ZN1A4  
1982/ZN29A4  
1982/ZN31A78

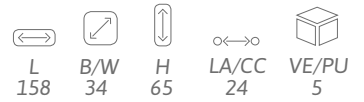

1981



Druckguss - Kunststoff / die cast - plastic

Passend zu 1896, 1897, 1898 Seite 96  
matching 1896, 1897, 1898 page 96

Bestellnummer | Order no.  
1981/ZN1A4  
1981/ZN29A4  
1981/ZN31A78

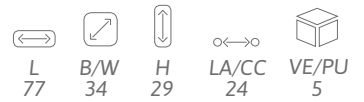

1980



Druckguss - Kunststoff / die cast - plastic

Passend zu 1971, 1972, 1973 Seite 90  
matching 1971, 1972, 1973 page 90

Bestellnummer | Order no.  
1980/ZN1A4  
1980/ZN29A4  
1980/ZN31A78

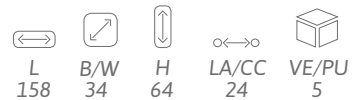

1979



Bestellnummer | Order no.  
1979/ZN1A4  
1979/ZN29A4  
1979/ZN31A78



Druckguss - Kunststoff / die cast - plastic

Passend zu 1971, 1972, 1973 Seite 90  
matching 1971, 1972, 1973 page 90



Abbildung: 1979/ZN29A4, 1980/ZN29A4, 1981/ZN29A4, 1982/ZN29A4





1938



Druckguss / die cast

Bestellnummer | Order no.  
1938/PB21  
1938/ZN1  
1938/ZN21



 L 100	 B/W 100	 H 40	 LA/CC 20	 VE/PU 5
--	--	---	---	--

1871





In Holland, Belgien und Deutschland nicht lieferbar / Not available in Netherlands, Belgium and Germany



Druckguss / die cast

Bestellnummer | Order no.  
1871/AL1  
1871/AL62



 L 125	 B/W 76	 H 88	 LA/CC 14	 VE/PU 5
--	---	---	---	--





1821



Druckguss / die cast

Bestellnummer | Order no.  
1821/ZN21  
1821/ZN75  
1821/ZN55



 L 128	 B/W 55	 H 57	 LA/CC 61	 VE/PU 5
--	---	---	---	--

Passend zu 1816 Seite 100  
matching 1816 page 100





1786



Druckguss / die cast

Bestellnummer | Order no.  
1786/PB1  
1786/PB8  
1786/PB21  
1786/ZN1  
1786/ZN4  
1786/ZN5



 L 60	 B/W 56	 H 23	 LA/CC 32	 VE/PU 5
---	---	---	---	--

1785





In Holland, Belgien und Deutschland nicht lieferbar / Not available in Netherlands, Belgium and Germany



Druckguss / die cast

Bestellnummer | Order no.  
1785/AL1  
1785/AL62



 L 42	 B/W 78	 H 56	 LA/CC 16	 VE/PU 5
---	---	---	---	--



Abbildung: 1821/ZN75

1789 handbemalt / hand painted



Bestellnummer | Order no.  
1789/ZN1A55

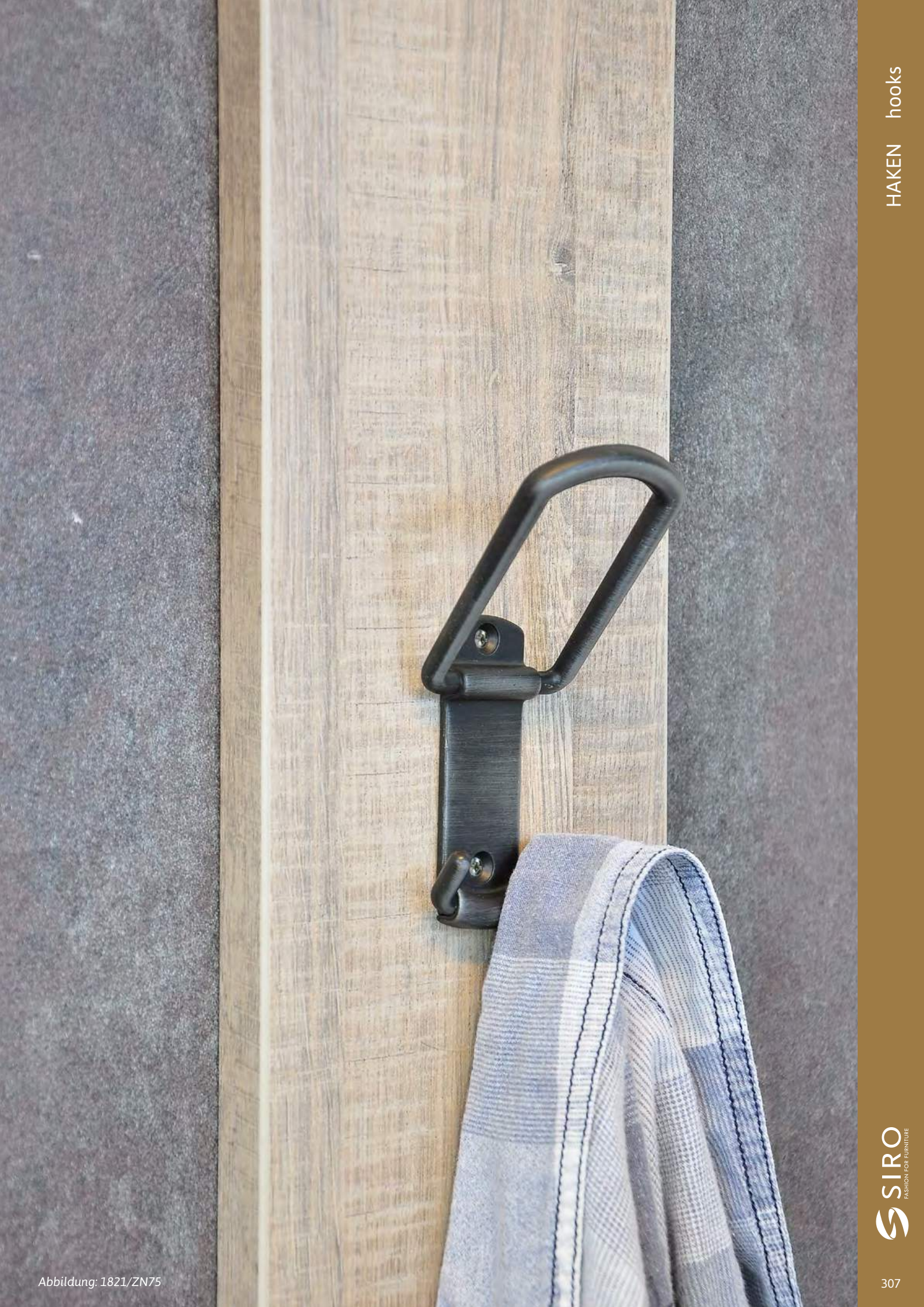

ZN1A55

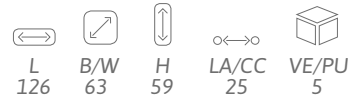

Druckguss - Kunststoff / die cast - plastic

Passend zu H125 Seite 230  
matching H125 page 230

1788 handbemalt / hand painted



Bestellnummer | Order no.  
1788/ZN1A54



ZN1A54

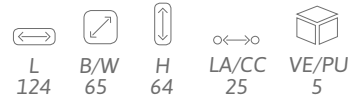

Druckguss - Kunststoff / die cast - plastic

Passend zu H123 Seite 231  
matching H123 page 231

1787 handbemalt / hand painted



Bestellnummer | Order no.  
1787/ZN1A53



ZN1A53

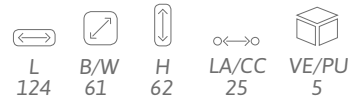

Druckguss - Kunststoff / die cast - plastic

Passend zu H122 Seite 231  
matching H122 page 231

1747



Druckguss / die cast

Bestellnummer | Order no.  
1747/AL2  
1747/PB1  
1747/PB8  
1747/PB13



AL2 PB1 PB8 PB13

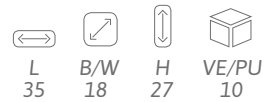

1672



Druckguss / die cast

Bestellnummer | Order no.  
1672/ZN1  
1672/ZN21



ZN1 ZN21

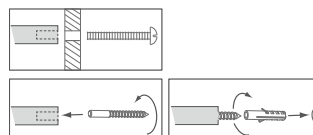
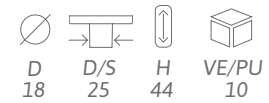

○←→ LOCHABSTAND | CENTER TO CENTER

↔ LÄNGE | LENGTH

📦 VERPACKUNGSEINHEIT | PACKING UNIT

📏 BREITE | WIDTH

⊘ DURCHMESSER | DIAMETER

📏 HÖHE | HEIGHT





Abbildung: 1789/ZN1A55, 1788/ZN1A54, 1787/ZN1A53



1670



Druckguss / die cast

Bestellnummer | Order no.  
 1670/PB21  
 1670/ZN1  
 1670/ZN4  
 1670/ZN21

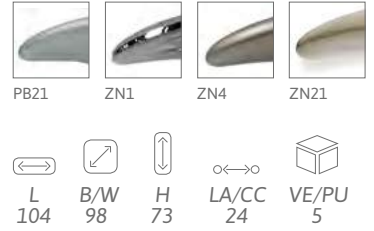

1669



Druckguss / die cast

Bestellnummer | Order no.  
 1669/PB21  
 1669/ZN1  
 1669/ZN4  
 1669/ZN5  
 1669/ZN21



1654



Druckguss / die cast

Bestellnummer | Order no.  
 1654/PB21  
 1654/ZN1  
 1654/ZN4  
 1654/ZN5  
 1654/ZN21

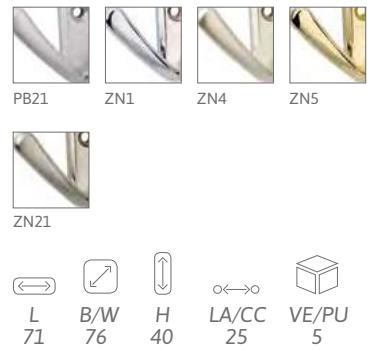

Passend zu 1651, 1652 Seite 112  
 matching 1651, 1652 page 112

1653



Druckguss / die cast

Bestellnummer | Order no.  
 1653/PB21  
 1653/ZN1  
 1653/ZN4  
 1653/ZN5  
 1653/ZN21

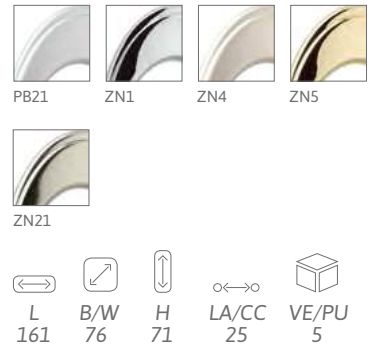

Passend zu 1651, 1652 Seite 112  
 matching 1651, 1652 page 112

1607



Druckguss / die cast

Bestellnummer | Order no.  
 1607/ZN1  
 1607/ZN2  
 1607/ZN4  
 1607/ZN5  
 1607/ZN21

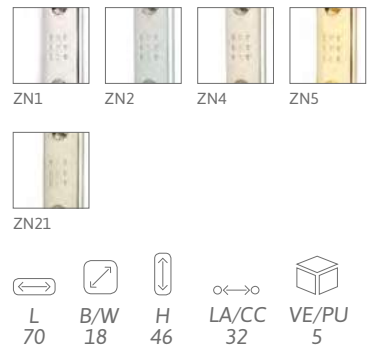

Passend zu 1313, 1314 Seite 140  
 matching 1313, 1314 page 140

1606



Druckguss / die cast

Bestellnummer | Order no.  
 1606/ZN1  
 1606/ZN2  
 1606/ZN4  
 1606/ZN5  
 1606/ZN21

Passend zu 1313, 1314 Seite 140  
 matching 1313, 1314 page 140



ZN1 ZN2 ZN4 ZN5



ZN21



L 150 B/W 18 H 63 LA/CC 32 VE/PU 5

1605



Druckguss / die cast

Bestellnummer | Order no.  
 1605/ZN1  
 1605/ZN2  
 1605/ZN4  
 1605/ZN5  
 1605/ZN21

Passend zu 1309, 1310 Seite 140  
 matching 1309, 1310 page 140



ZN1 ZN2 ZN4 ZN5



ZN21



L 52 B/W 20 H 45 LA/CC 16 VE/PU 5

1604



Druckguss / die cast

Bestellnummer | Order no.  
 1604/ZN1  
 1604/ZN2  
 1604/ZN4  
 1604/ZN5  
 1604/ZN21

Passend zu 1309, 1310 Seite 140  
 matching 1309, 1310 page 140



ZN1 ZN2 ZN4 ZN5



ZN21



L 154 B/W 20 H 77 LA/CC 16 VE/PU 5

1463



Stahl / steel

Bestellnummer | Order no.  
 1463/ZN4

Passend zu 1464 Seite 367, 1783 Seite 366  
 matching 1464 page 367, 1783 page 366



ZN4



L 126 B/W 50 H 80 LA/CC 24 VE/PU 5



1427



Druckguss / die cast

Bestellnummer | Order no.  
1427-40ZN1  
1427-40ZN2

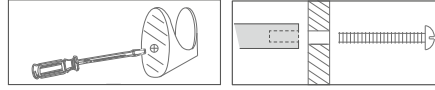

Auch als Knopf verwendbar!  
Can be also used as knob!



L 40    B/W 24    H 30    VE/PU 10

1426



Druckguss / die cast

Bestellnummer | Order no.  
1426-40ZN1  
1426-40ZN2

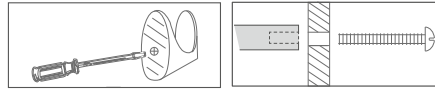

Auch als Knopf verwendbar!  
Can be also used as knob!



L 40    B/W 22    H 30    VE/PU 10

1425



Druckguss / die cast

Bestellnummer | Order no.  
1425-40ZN1  
1425-40ZN2

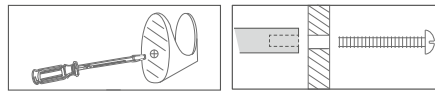

Auch als Knopf verwendbar!  
Can be also used as knob!



L 40    B/W 40    H 30    VE/PU 10

1424



Druckguss / die cast

Bestellnummer | Order no.  
1424-40ZN1  
1424-40ZN2  
1424-40ZN21

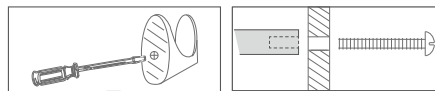

Auch als Knopf verwendbar!  
Can be also used as knob!



L 40    B/W 22    H 30    VE/PU 10

1421



Stahl / steel

Bestellnummer | Order no.  
1421/PB1  
1421/PB12  
1421/ZN9  
1421/ZN10



L 61    B/W 70    H 40    LA/CC 24    VE/PU 5

Passend zu 1267, 1268, 1303, 1304 Seite 142  
matching 1267, 1268, 1303, 1304 page 142

LOCHABSTAND | CENTER TO CENTER

VERPACKUNGSEINHEIT | PACKING UNIT

DURCHMESSER | DIAMETER

LÄNGE (OBEN - UNTEN) | LENGTH (UP - DOWN)

BREITE | WIDTH

HÖHE (ABSTAND ZUR WAND) | HEIGHT (DISTANCE TO WALL)

1420



Stahl / steel



PB12

ZN9

Bestellnummer | Order no.  
1420/PB12  
1420/ZN9



Passend zu 1267, 1268, 1303, 1304 Seite 142  
matching 1267, 1268, 1303, 1304 page 142

Modellübersicht Seite 142  
Product overview page 142



1304-104PB12

1304-136PB12

1268-51PB12

1268-62PB12

1268-74PB12

1303-40PB12

1267-115PB12

1303-34PB12

1267-147PB12



Abbildung: 1426-40ZN2, 1425-40ZN2, 1424-40ZN2, 1427-40ZN2

1354



Druckguss / die cast

Bestellnummer | Order no.  
1354/ZN1  
1354/ZN2  
1354/ZN4



L	B/W	H	LA/CC	VE/PU
84	20	43	16	5

1353



Druckguss - Kunststoff / die cast - plastic

Bestellnummer | Order no.  
1353/ZN2MT1  
1353/ZN2T7



L	B/W	H	LA/CC	VE/PU
163	20	99	16	5

1322



Druckguss / die cast

Bestellnummer | Order no.  
1322/ZN1  
1322/ZN2  
1322/ZN4  
1322/ZN10  
1322/ZN21

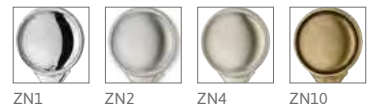

L	B/W	H	LA/CC	VE/PU
64	40	32	23	5

1321



Druckguss / die cast

Bestellnummer | Order no.  
1321/ZN1  
1321/ZN2  
1321/ZN4  
1321/ZN10  
1321/ZN21

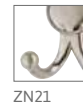

L	B/W	H	LA/CC	VE/PU
188	72	78	23	5

1294



Stahl - Holz / steel - wood

Bestellnummer | Order no.  
1294/PB18HZ34  
1294/PB19HZ34



L	B/W	H	LA/CC	VE/PU
40	50	56	32	5

Passend zu 1290, 1295 Seite 368, 1296 Seite 381  
matching 1290, 1295 page 368, 1296 page 381

LOCHABSTAND | CENTER TO CENTER

VERPACKUNGSEINHEIT | PACKING UNIT

DURCHMESSER | DIAMETER

LÄNGE (OBEN - UNTEN) | LENGTH (UP - DOWN)

BREITE | WIDTH

HÖHE (ABSTAND ZUR WAND) | HEIGHT (DISTANCE TO WALL)

1293



Stahl - Holz / steel - wood

Passend zu 1290, 1295 Seite 368, 1296 Seite 381  
matching 1290, 1295 page 368, 1296 page 381

Bestellnummer | Order no.  
1293/PB18HZ34  
1293/PB19HZ34



PB18HZ34 PB19HZ34



1292



Stahl - Holz / steel - wood

Passend zu 1290, 1295 Seite 368, 1296 Seite 381  
matching 1290, 1295 page 368, 1296 page 381

Bestellnummer | Order no.  
1292/PB18HZ34  
1292/PB19HZ34

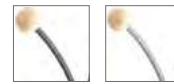

PB18HZ34 PB19HZ34



Abbildung: 1321/ZN21, 1322/ZN21

1281



Druckguss / die cast

Bestellnummer | Order no.  
 1281/PB21  
 1281/ZN1  
 1281/ZN4  
 1281/ZN5  
 1281/ZN21



PB21 ZN1 ZN4 ZN5



ZN21

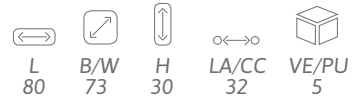

L 80 B/W 73 H 30 LA/CC 32 VE/PU 5

1280



Druckguss / die cast

Bestellnummer | Order no.  
 1280/PB21  
 1280/ZN1  
 1280/ZN4  
 1280/ZN5



PB21 ZN1 ZN4 ZN5

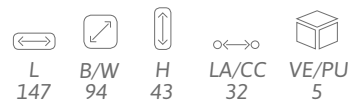

L 147 B/W 94 H 43 LA/CC 32 VE/PU 5

1279



Druckguss / die cast

Bestellnummer | Order no.  
 1279/PB21  
 1279/ZN1  
 1279/ZN4



PB21 ZN1 ZN4

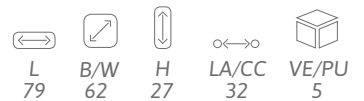

L 79 B/W 62 H 27 LA/CC 32 VE/PU 5

1278



Druckguss / die cast

Bestellnummer | Order no.  
 1278/PB21  
 1278/ZN1  
 1278/ZN4



PB21 ZN1 ZN4

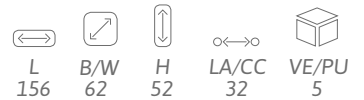

L 156 B/W 62 H 52 LA/CC 32 VE/PU 5

1277



Druckguss / die cast

Bestellnummer | Order no.  
 1277/ZN29



ZN29

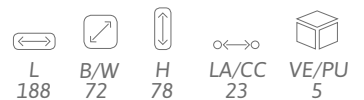

L 188 B/W 72 H 78 LA/CC 23 VE/PU 5

Passend zu 1071, 1076 Seite 348, 1072, 1075 Seite 149, 1180, 1183, 1188 Seite 148, 5367 Seite 281, SP36 Seite 270  
 matching 1071, 1076 page 348, 1072, 1075 page 149, 1180, 1183, 1188 page 148, 5367 page 281, SP36 page 270

↔ LOCHABSTAND | CENTER TO CENTER

📦 VERPACKUNGSEINHEIT | PACKING UNIT

⌀ DURCHMESSER | DIAMETER

↕ LÄNGE (OBEN - UNTEN) | LENGTH (UP - DOWN)

↔ BREITE | WIDTH

📏 HÖHE (ABSTAND ZUR WAND) | HEIGHT (DISTANCE TO WALL)



1265



Druckguss / die cast

Passend zu 1082 Seite 149, 1083 Seite 348, 1185 Seite 148  
matching 1082 page 149, 1083 page 348, 1185 page 148

Bestellnummer | Order no.  
1265/ZN29



ZN29

L 188	B/W 72	H 78	LA/CC 23	VE/PU 5

1237



Druckguss / die cast

Bestellnummer | Order no.  
1237/ZN1  
1237/ZN4  
1237/ZN5  
1237/ZN10



ZN1 ZN4 ZN5 ZN10

L 145	B/W 95	H 52	LA/CC 32	VE/PU 5

1236



Druckguss / die cast

Bestellnummer | Order no.  
1236/PB1  
1236/ZN1  
1236/ZN4  
1236/ZN5  
1236/ZN10



PB1 ZN1 ZN4 ZN5



ZN10

L 147	B/W 101	H 52	LA/CC 32	VE/PU 5

Abbildung: 1278/PB21, 1279/PB21

1232



Druckguss / die cast

Passend zu 1207 Seite 147, 1223, 1225, 1227, 1228, 1235 Seite 144  
matching 1207 page 147, 1223, 1225, 1227, 1228, 1235 page 144

Bestellnummer | Order no.  
1232/ZN29



ZN29

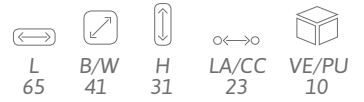

1230



Druckguss / die cast

Passend zu 1207 Seite 147, 1223, 1225, 1227, 1228, 1235 Seite 144  
matching 1207 page 147, 1223, 1225, 1227, 1228, 1235 page 144

Bestellnummer | Order no.  
1230/ZN29



ZN29

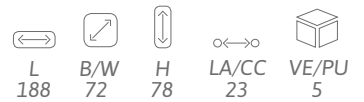

1241



Druckguss / die cast

Passend zu 1208 Seite 147, 1209, 1210, 1211, 1213, 1315 Seite 146  
matching 1208 page 147, 1209, 1210, 1211, 1213, 1315 page 146

Bestellnummer | Order no.  
1241/ZN29



ZN29

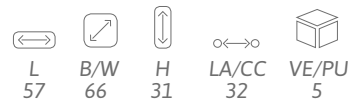

1220



Druckguss / die cast

Passend zu 1208 Seite 147, 1209, 1210, 1211, 1213, 1315 Seite 146  
matching 1208 page 147, 1209, 1210, 1211, 1213, 1315 page 146

Bestellnummer | Order no.  
1220/ZN29



ZN29

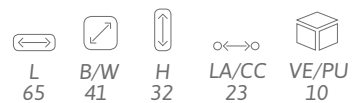

1218



Druckguss / die cast

Passend zu 1208 Seite 147, 1209, 1210, 1211, 1213, 1315 Seite 146  
matching 1208 page 147, 1209, 1210, 1211, 1213, 1315 page 146

Bestellnummer | Order no.  
1218/ZN29



ZN29

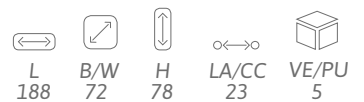

1217



Druckguss / die cast

Bestellnummer | Order no.  
1217/ZN29



ZN29



L  
188



B/W  
72



H  
78



LA/CC  
32



VE/PU  
5

Passend zu 1208 Seite 147, 1209, 1210, 1211, 1213, 1315 Seite 146  
matching 1208 page 147, 1209, 1210, 1211, 1213, 1315 page 146



1138



Druckguss / die cast

Bestellnummer | Order no.  
1138/AL2  
1138/PB1



AL2

PB1

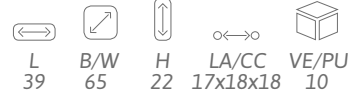

1137



Druckguss / die cast

Bestellnummer | Order no.  
1137/AL2  
1137/PB1



AL2

PB1

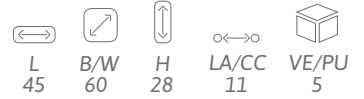

1136



Druckguss / die cast

Bestellnummer | Order no.  
1136/AL2  
1136/PB1  
1136/PB12



AL2

PB1

PB12

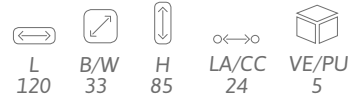

1134



Druckguss / die cast

Bestellnummer | Order no.  
1134/AL2  
1134/PB1  
1134/PB8  
1134/PB13  
1134/PB21



AL2

PB1

PB8

PB13



PB21

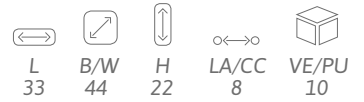

1133



Druckguss / die cast

Bestellnummer | Order no.  
1133/AL2  
1133/PB1  
1133/PB8  
1133/PB13  
1133/PB21



AL2

PB1

PB8

PB13



PB21

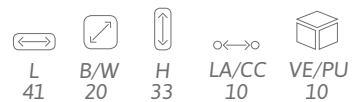

1132



Druckguss / die cast

Bestellnummer | Order no.  
1132/AL2  
1132/PB1  
1132/PB6



L	B/W	H	LA/CC	VE/PU
47	72	32	19x22x22	10

1131



Druckguss / die cast

Bestellnummer | Order no.  
1131/AL2  
1131/PB1  
1131/PB6



L	B/W	H	LA/CC	VE/PU
108	76	88	20x22x22	5



Abbildung: 1136/PB1, 1131/PB1, 1134/PB1, 1133/PB1, 1137/PB1, 1132/PB1, 1138/PB1

1116



Bestellnummer | Order no.  
1116/ZN28

Stahl - Druckguss / steel - die cast

Passend zu 1048 Seite 154  
matching 1048 page 154



ZN28



1115



Bestellnummer | Order no.  
1115/ZN28

Stahl - Druckguss / steel - die cast

Passend zu 1048 Seite 154  
matching 1048 page 154



ZN28



1098



Bestellnummer | Order no.  
1098/ZN1  
1098/ZN2  
1098/ZN4

Druckguss / die cast

Passend zu 873, 878 Seite 166  
matching 873, 878 page 166



ZN1

ZN2

ZN4

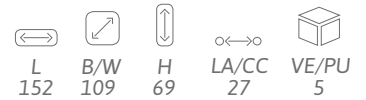

1097



Bestellnummer | Order no.  
1097/PB1  
1097/ZN1  
1097/ZN2  
1097/ZN4  
1097/ZN5  
1097/ZN8  
1097/ZN10

Druckguss / die cast

Passend zu 1161 Seite 370  
matching 1161 page 370



PB1

ZN1

ZN2

ZN4



ZN5

ZN8

ZN10



1096



Bestellnummer | Order no.  
1096/PB1  
1096/ZN1  
1096/ZN2  
1096/ZN4  
1096/ZN5  
1096/ZN8  
1096/ZN10

Druckguss / die cast

Passend zu 1161 Seite 370  
matching 1161 page 370



PB1

ZN1

ZN2

ZN4



ZN5

ZN8

ZN10

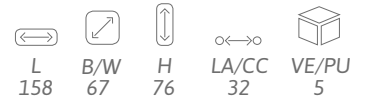

1064



Druckguss / die cast

Bestellnummer | Order no.  
1064/PB12  
1064/ZN1  
1064/ZN21  
1064/ZN31



				
L	B/W	H	LA/CC	VE/PU
142	114	57	32	5

851



Stahl / steel

Bestellnummer | Order no.  
851/ZN1  
851/ZN4



				
L	B/W	H	LA/CC	VE/PU
126	61	46	52	5

817



Druckguss / die cast

Bestellnummer | Order no.  
817/ZN10



				
L	B/W	H	LA/CC	VE/PU
145	95	52	32	5



Abbildung: 1097/ZN8, 1096/ZN8

748

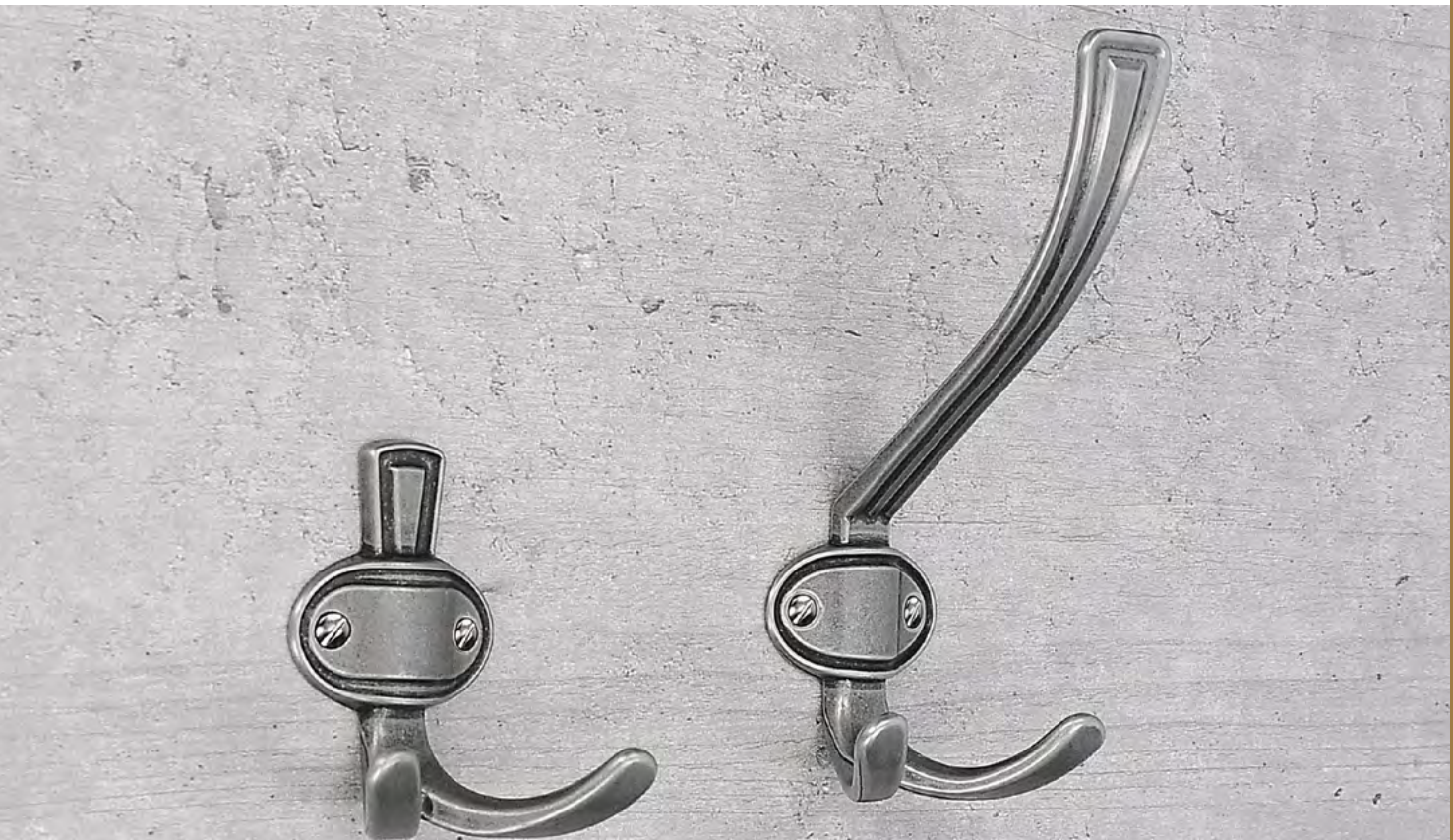

Druckguss / die cast

Bestellnummer | Order no.  
748/ZN1  
748/ZN4  
748/ZN5

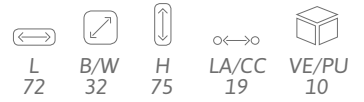

746



Druckguss / die cast

Bestellnummer | Order no.  
746/ZN1  
746/ZN4  
746/ZN5

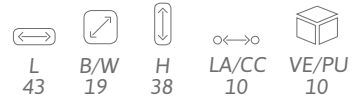
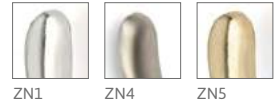

745



Druckguss / die cast

Bestellnummer | Order no.  
745/ZN1  
745/ZN4  
745/ZN5

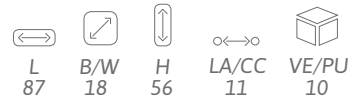

743



Druckguss / die cast

Bestellnummer | Order no.  
743/ZN1  
743/ZN4  
743/ZN5

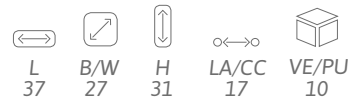

Passend zu 743 Seite 355  
matching 743 page 355

704



Druckguss / die cast

Bestellnummer | Order no.  
704/PB1  
704/ZN1  
704/ZN4  
704/ZN5  
704/ZN10

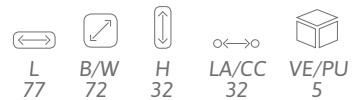



703



Druckguss / die cast

Bestellnummer | Order no.

703/PB1  
703/ZN1  
703/ZN4  
703/ZN5  
703/ZN10



PB1



ZN1



ZN4



ZN5



ZN10



L  
175



B/W  
73



H  
74



LA/CC  
32



VE/PU  
5



Abbildung: 703/ZN10, 704/ZN10

583



Druckguss / die cast

Bestellnummer | Order no.  
583/ZN1  
583/ZN3  
583/ZN5

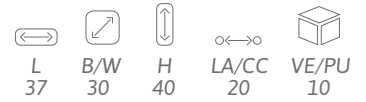

L 37  
B/W 30  
H 40  
LA/CC 20  
VE/PU 10

582



Druckguss / die cast

Bestellnummer | Order no.  
582/ZN1  
582/ZN3  
582/ZN4  
582/ZN5

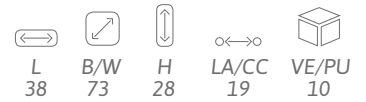

L 38  
B/W 73  
H 28  
LA/CC 19  
VE/PU 10

581



Druckguss / die cast

Bestellnummer | Order no.  
581/ZN3



L 82  
B/W 73  
H 76  
LA/CC 23  
VE/PU 5

580



Druckguss / die cast

Bestellnummer | Order no.  
580/ZN1  
580/ZN3  
580/ZN4  
580/ZN5

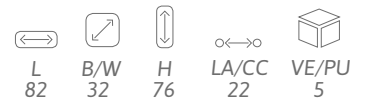

L 82  
B/W 32  
H 76  
LA/CC 22  
VE/PU 5

558



Druckguss / die cast

Bestellnummer | Order no.  
558/ZN5  
558/ZN10

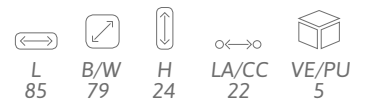

L 85  
B/W 79  
H 24  
LA/CC 22  
VE/PU 5

557



Druckguss / die cast

Bestellnummer | Order no.  
557/ZN5  
557/ZN10



ZN5



ZN10



L  
179



B/W  
79



H  
70



LA/CC  
62



VE/PU  
5



Abbildung: 583/ZN3, 582/ZN3, 581/ZN3, 580/ZN3

554

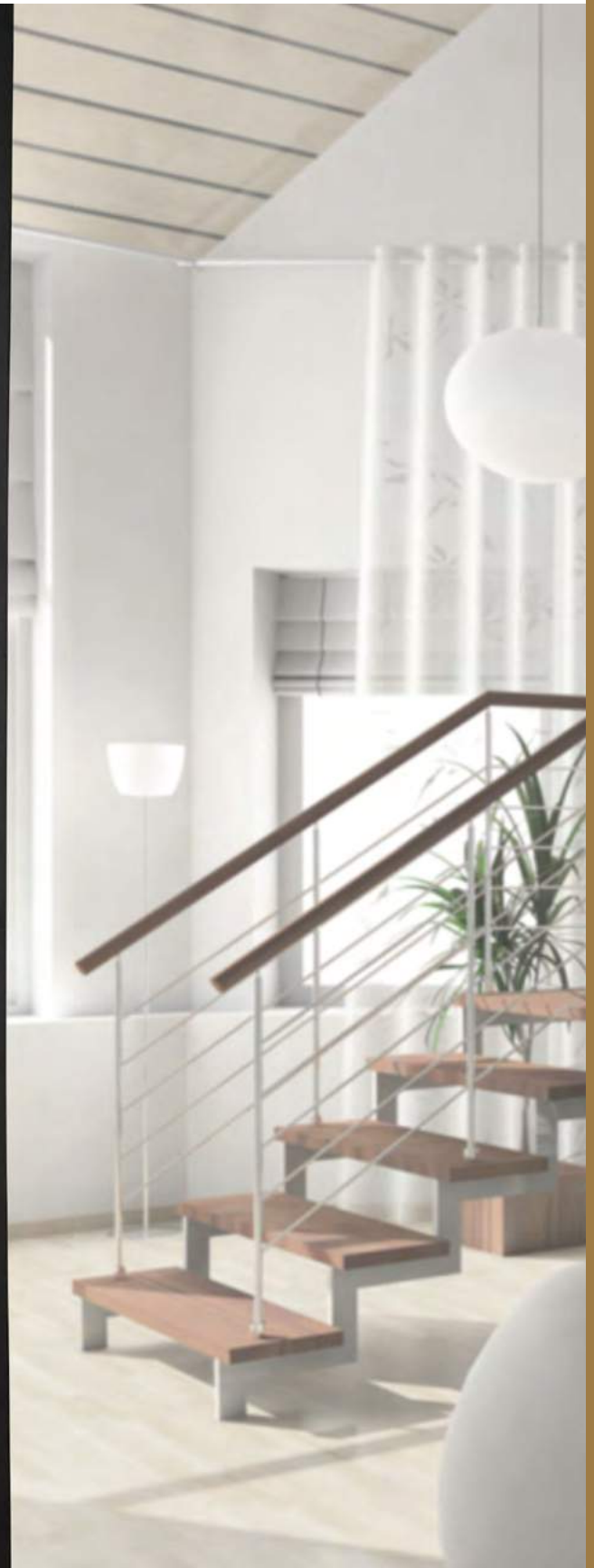

Druckguss / die cast

Bestellnummer | Order no.  
 554/ZN4  
 554/ZN5  
 554/ZN10  
 554/ZN21

ZN4	ZN5	ZN10	ZN21
L 56	B/W 75	H 24	LA/CC 32
			VE/PU 5

553



Druckguss / die cast

Bestellnummer | Order no.  
 553/ZN4  
 553/ZN5  
 553/ZN10  
 553/ZN21

ZN4	ZN5	ZN10	ZN21
L 160	B/W 75	H 75	LA/CC 32
			VE/PU 5

548



Druckguss / die cast

Bestellnummer | Order no.  
 548/ZN5  
 548/ZN8  
 548/ZN10

ZN5	ZN8	ZN10
L 67	B/W 84	H 33
		LA/CC 32
		VE/PU 5

547



Druckguss / die cast

Bestellnummer | Order no.  
 547/ZN5  
 547/ZN8  
 547/ZN10

ZN5	ZN8	ZN10
L 169	B/W 85	H 76
		LA/CC 32
		VE/PU 5

507



Druckguss / die cast

Bestellnummer | Order no.  
 507/ZN5  
 507/ZN8  
 507/ZN10

ZN5	ZN8	ZN10
L 64	B/W 57	H 18
		LA/CC 27
		VE/PU 5

506



Druckguss / die cast

Bestellnummer | Order no.  
506/ZN5  
506/ZN8  
506/ZN10



				
L 151	B/W 52	H 67	LA/CC 27	VE/PU 5





505



Druckguss / die cast

Bestellnummer | Order no.  
505/ZN1  
505/ZN5  
505/ZN8  
505/ZN10



				
L 66	B/W 56	H 20	LA/CC 24	VE/PU 5

504



Druckguss / die cast

Bestellnummer | Order no.  
504/ZN1  
504/ZN5  
504/ZN8  
504/ZN10



				
L 152	B/W 58	H 61	LA/CC 26	VE/PU 5

Passend zu 618 Seite 370  
matching 618 page 370



Abbildung: 547/ZN8

431



Druckguss / die cast

Bestellnummer | Order no.  
431/ZN8  
431/ZN10



L	B/W	H	LA/CC	VE/PU
65	61	28	19	5

430



Druckguss / die cast

Bestellnummer | Order no.  
430/ZN8  
430/ZN10



L	B/W	H	LA/CC	VE/PU
148	58	68	19	5

418



Druckguss / die cast

Bestellnummer | Order no.  
418/ZN8  
418/ZN10



L	B/W	H	LA/CC	VE/PU
51	43	21	16	10

328



Messing / solid brass

Bestellnummer | Order no.  
328/MS1  
328/MS3



L	B/W	H	LA/CC	VE/PU
156	67	67	34	5

327



Messing / solid brass

Bestellnummer | Order no.  
327/MS1



L	B/W	H	LA/CC	VE/PU
71	60	22	34	5



Abbildung: 430/ZN8, 431/ZN8

2418



Edelstahl / stainless steel



N1

Bestellnummer | Order no.  
2418/N1

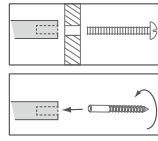

D 20    D/S 10    H 45    VE/PU 5

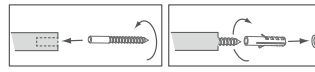

2403

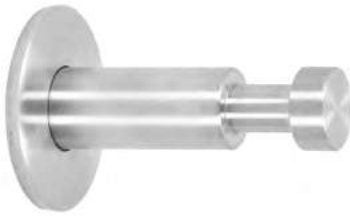

Edelstahl / stainless steel



N1

Bestellnummer | Order no.  
2403/N1

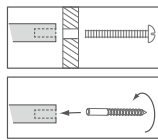

D 14    D/S 35    H 52    VE/PU 5

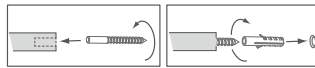

2360



Edelstahl / stainless steel



N1

Bestellnummer | Order no.  
2360/N1

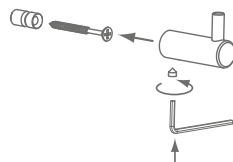

L 38    D/S 35    H 42    VE/PU 5

Passend zu 1658 Seite 337, 1824, 1825 Seite 336, 2283 Seite 335  
 matching 1658 page 337, 1824, 1825 page 336, 2283 page 335

LOCHABSTAND | CENTER TO CENTER

VERPACKUNGSEINHEIT | PACKING UNIT

DURCHMESSER | DIAMETER

LÄNGE (OBEN - UNTEN) | LENGTH (UP - DOWN)

BREITE | WIDTH

HÖHE (ABSTAND ZUR WAND) | HEIGHT (DISTANCE TO WALL)





Abbildung: 2360/N1

HAKEN EDELSTAHL hooks stainless steel

2316 hohl / hollow

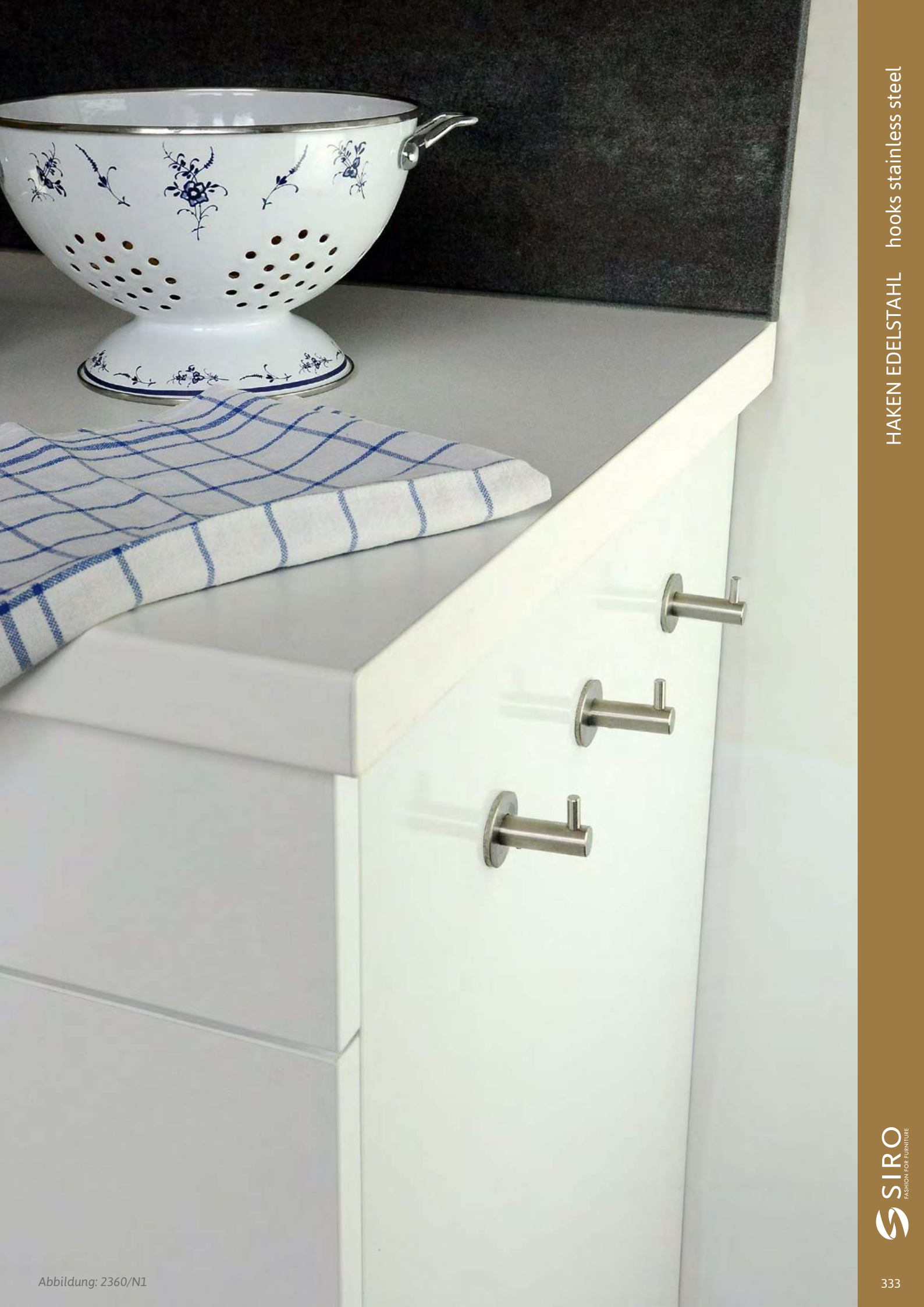

Edelstahl / stainless steel

Passend zu 2277 Seite 189  
matching 2277 page 189

2315 hohl / hollow



Edelstahl / stainless steel

Passend zu 2277 Seite 189  
matching 2277 page 189

2302 hohl / hollow



Edelstahl / stainless steel

Passend zu 2277 Seite 189  
matching 2277 page 189

2301 hohl / hollow



Edelstahl / stainless steel

Passend zu 2277 Seite 189  
matching 2277 page 189

2286



Edelstahl / stainless steel

Bestellnummer | Order no.  
2316/N1

Bestellnummer | Order no.  
2315/N1

Bestellnummer | Order no.  
2302/N1

Bestellnummer | Order no.  
2301/N1

Bestellnummer | Order no.  
2286-32N1  
2286-55N1



N1

L 95	B/W 16	H 57	LA/CC 32	VE/PU 5



N1

L 150	B/W 16	H 79	LA/CC 32	VE/PU 5



N1

L 120	B/W 16	H 50	LA/CC 32	VE/PU 5



N1

L 200	B/W 16	H 69	LA/CC 32	VE/PU 5



N1

L 42 42	B/W 64 64	H 32 55	LA/CC 28 28	VE/PU 5 5

2283



Edelstahl / stainless steel

Passend zu 1658 Seite 337, 1824, 1825 Seite 336, 2360 Seite 332  
 matching 1658 page 337, 1824, 1825 page 336, 2360 page 332

Bestellnummer | Order no.  
 2283-29N1  
 2283-42N1  
 2283-64N1

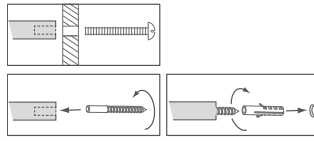

N1

D	H	VE/PU
35	29	5
35	42	5
35	64	5

2282



Edelstahl / stainless steel

Bestellnummer | Order no.  
 2282-42N1  
 2282-62N1

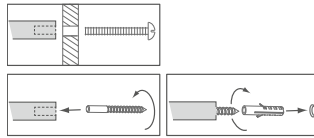

N1

L	B/W	H	VE/PU
35	35	42	5
35	35	62	5



Abbildung: 2315/N1, 2316/N1

2259



Edelstahl / stainless steel

Bestellnummer | Order no.  
2259/N1

Passend zu 2196 Seite 363, 2255, 2256 Seite 362, 2257 Seite 378  
matching 2196 page 363, 2255, 2256 page 362, 2257 page 378

2258



Edelstahl / stainless steel

Bestellnummer | Order no.  
2258/N1

Passend zu 2196 Seite 363, 2255, 2256 Seite 362, 2257 Seite 378  
matching 2196 page 363, 2255, 2256 page 362, 2257 page 378

2106



Edelstahl / stainless steel

Bestellnummer | Order no.  
2106-27N1  
2106-42N1  
2106-62N1

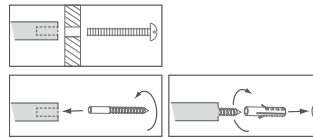

1825



Edelstahl / stainless steel

Bestellnummer | Order no.  
1825/N1

Passend zu 2283 Seite 335, 2360 Seite 332  
matching 2283 page 335, 2360 page 332

1824



Edelstahl / stainless steel

Bestellnummer | Order no.  
1824/N1

Passend zu 2283 Seite 335, 2360 Seite 332  
matching 2283 page 335, 2360 page 332



N1

L	B/W	H	LA/CC	VE/PU
100	77	36	32	5



N1

L	B/W	H	LA/CC	VE/PU
173	76	103	32	5



N1

L	B/W	H	VE/PU
38	35	27	5
38	35	42	5
38	35	62	5



N1

L	D/S	H	VE/PU
38	35	62	5



N1

L	D/S	H	VE/PU
38	35	27	5

LOCHABSTAND | CENTER TO CENTER

VERPACKUNGSEINHEIT | PACKING UNIT

DURCHMESSER | DIAMETER

LÄNGE (OBEN - UNTEN) | LENGTH (UP - DOWN)

BREITE | WIDTH

HÖHE (ABSTAND ZUR WAND) | HEIGHT (DISTANCE TO WALL)

1658



Edelstahl / stainless steel

Passend zu 2283 Seite 335, 2360 Seite 332  
matching 2283 page 335, 2360 page 332

Bestellnummer | Order no.  
1658/N1

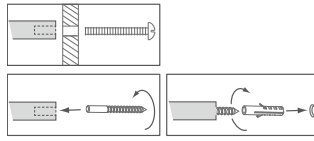

N1

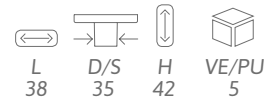

1401



Edelstahl / stainless steel

Bestellnummer | Order no.  
1401/N1



N1



1400



Edelstahl / stainless steel

Bestellnummer | Order no.  
1400/N1



N1



Abbildung: 2259/N1



01040



Kunststoff / plastic

Bestellnummer | Order no.  
01040/K10  
01040/MT1  
01040/MV11



K10 MT1 MV11

L 139  
 B/W 110  
 H 55  
 LA/CC 20  
 VE/PU 5

01020



Kunststoff / plastic

Bestellnummer | Order no.  
01020/MT1  
01020/MV11



MT1 MV11

L 34  
 B/W 61  
 H 25  
 VE/PU 10

01019



Kunststoff / plastic

Bestellnummer | Order no.  
01019/MT1K63  
01019/MV11K63



MT1K63 MV11K63

L 56  
 B/W 34  
 H 39  
 VE/PU 5



inklusive Montageteil / mounting part included

01018



Kunststoff / plastic

Bestellnummer | Order no.  
01018/MT1K63  
01018/MV11K63



MT1K63 MV11K63

L 64  
 B/W 47  
 H 33  
 VE/PU 5



inklusive Montageteil / mounting part included

0859



Kunststoff / plastic

Bestellnummer | Order no.  
0859/MV11



MV11

L 140  
 B/W 35  
 H 70  
 LA/CC 57  
 VE/PU 5

Passend zu 0819 Seite 182  
matching 0819 page 182

LOCHABSTAND | CENTER TO CENTER

VERPACKUNGSEINHEIT | PACKING UNIT

DURCHMESSER | DIAMETER

LÄNGE (OBEN - UNTEN) | LENGTH (UP - DOWN)

BREITE | WIDTH

HÖHE (ABSTAND ZUR WAND) | HEIGHT (DISTANCE TO WALL)

0858



Kunststoff / plastic

Bestellnummer | Order no.  
0858/MV11



MV11



L  
45



B/W  
35



H  
46



LA/CC  
18



VE/PU  
5

Passend zu 0819 Seite 212  
matching 0819 page 212

0853



Kunststoff / plastic

Bestellnummer | Order no.  
0853/K10  
0853/K52  
0853/KGSA1MT1  
0853/MV11



K10



K52



KGSA1MT1



MV11



L  
51



B/W  
22



H  
57



LA/CC  
20



VE/PU  
5



Abbildung: 01040/MT1

0617



Kunststoff / plastic

Bestellnummer | Order no.  
0617/MV11MT1



MV11MT1

L 73	B/W 24	H 64	LA/CC 19	VE/PU 5

0616



Kunststoff / plastic

Bestellnummer | Order no.  
0616/MV11MT1



MV11MT1

L 160	B/W 24	H 90	LA/CC 19	VE/PU 5

0488



Kunststoff / plastic

Bestellnummer | Order no.  
0488/K1  
0488/K10  
0488/MV7



K1

K10

MV7

L 70	B/W 18	H 60	LA/CC 20	VE/PU 5

Passend zu 0498 Seite 397  
matching 0498 page 397

0487



Kunststoff / plastic

Bestellnummer | Order no.  
0487/K1  
0487/K10  
0487/MV7



K1

K10

MV7

L 154	B/W 18	H 93	LA/CC 20	VE/PU 5

Passend zu 0498 Seite 397  
matching 0498 page 397

0417



Kunststoff / plastic

Bestellnummer | Order no.  
0417/K1  
0417/K2  
0417/K10  
0417/K52  
0417/MV7



K1

K2

K10

K52



MV7

L 62	B/W 57	H 62	LA/CC 20	VE/PU 5



0416



Kunststoff / plastic

Bestellnummer | Order no.  
0416/K1  
0416/K2  
0416/K10  
0416/K52  
0416/MV7



K1 K2 K10 K52



MV7



0292



Kunststoff / plastic

Bestellnummer | Order no.  
0292/K10



K10



Abbildung: 0487/MV7, 0488/MV7

H195

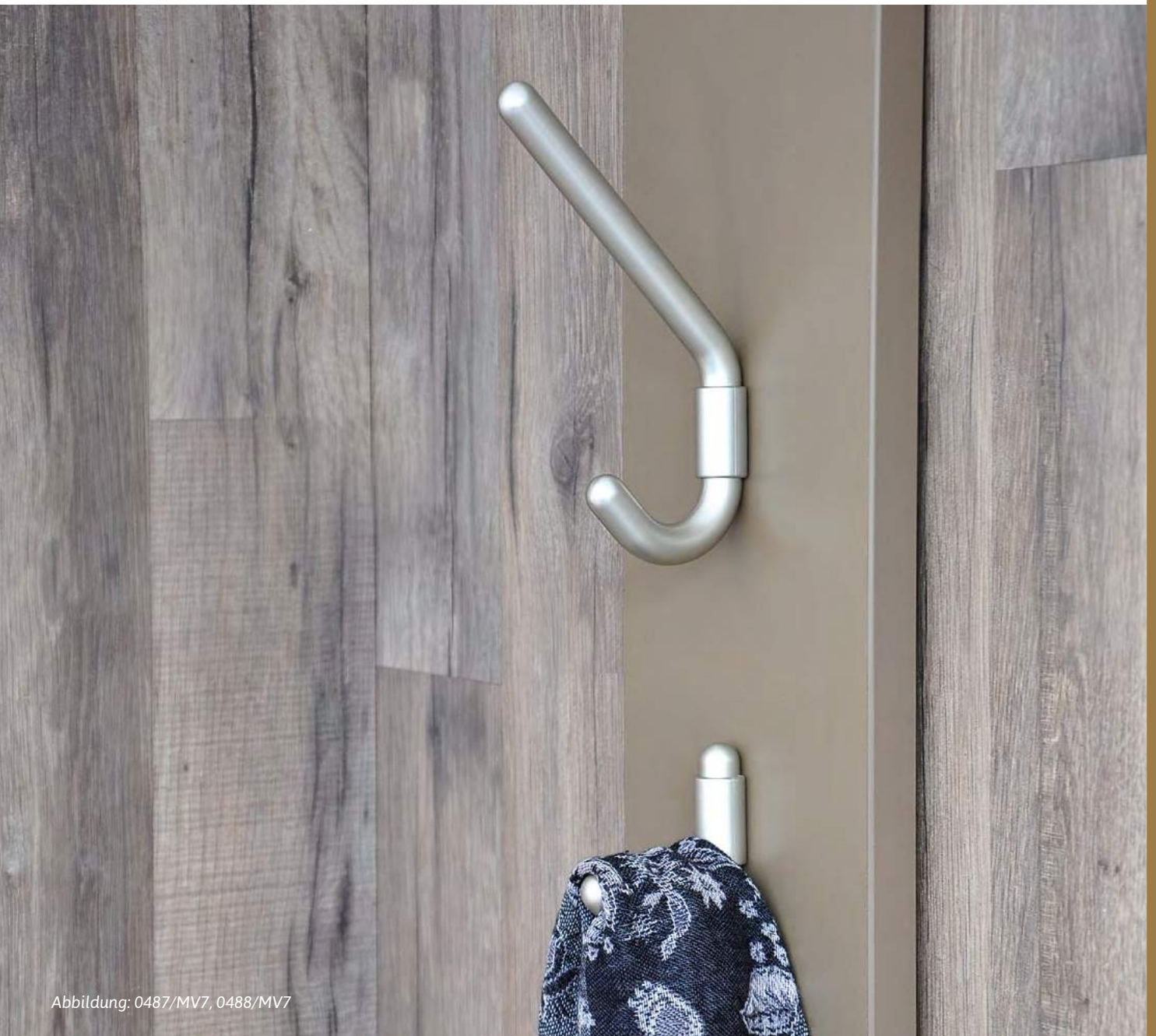

Kunststoff / plastic

Bestellnummer | Order no.  
 H195/A4V1KB  
 H195/A105V1KB  
 H195/E2V1KB  
 H195/G1V1KB

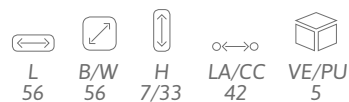
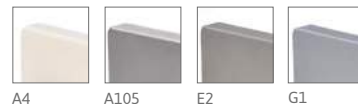
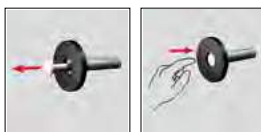

Einbohrtiefe / drilling depth  
 Ø 14 mm  
 L 65 mm

H194



Kunststoff / plastic

Bestellnummer | Order no.  
 H194/A105V1KB  
 H194/E2V1KB  
 H194/G1V1KB

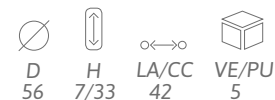
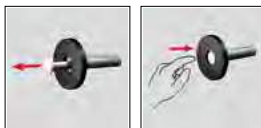

Einbohrtiefe / drilling depth  
 Ø 14 mm  
 L 65 mm

H111

selbsthaftend / self-adhesive



Stahl - Kunststoff / steel - plastic

Bestellnummer | Order no.  
 H111-46A45FE11V5K\*



A45FE11

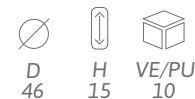

\* Bestellnr. für 5 Stück / order no. for 5 pcs.  
 VE / MOQ : 10 = 50 Stück / pieces

H033



Kunststoff / plastic

Bestellnummer | Order no.  
 H033-25A4V3\*  
 H033-25A12V3\*

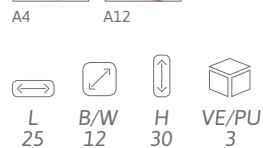

\* Bestellnr. für 3 Stück / order no. for 3 pcs.  
 VE / MOQ : 3 = 9 Stück / pieces

H008



Kunststoff / plastic

Bestellnummer | Order no.  
 H008/A4  
 H008/A5  
 H008/A7  
 H008/K90

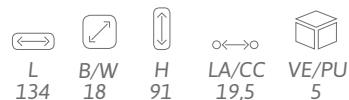

H007



Kunststoff / plastic

Bestellnummer | Order no.  
H007/A4  
H007/A5  
H007/A7  
H007/K90



A4	A5	A7	K90	
L 51	B/W 18	H 58	LA/CC 19,5	VE/PU 5

SM8252



Kunststoff / plastic

Bestellnummer | Order no.  
SM8252-70K10



K10				
L 70	B/W 25	H 57	LA/CC 20	VE/PU 5



Abbildung: SM8252-70K10

L150



Holz / wood

Bestellnummer | Order no.  
L150-62HZ5



HZ5



Dübel / dowel Ø 12 mm  
L 9 mm

L36



Holz / wood

Bestellnummer | Order no.  
L36-18HZ16



HZ16



Dübel / dowel Ø 10 mm  
L 10 mm

S156



Holz mit M6 Metallmuffe /  
wood with M6 metal thread

Bestellnummer | Order no.  
S156-97HZ6  
S156-97HZ14  
S156-97HZ16

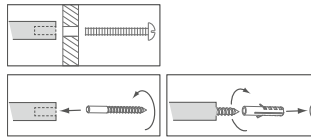

HZ6

HZ14

HZ16



S155



Holz mit M4 Metallmuffe /  
wood with M4 metal thread

Bestellnummer | Order no.  
S155-60HZ6  
S155-60HZ14  
S155-60HZ16

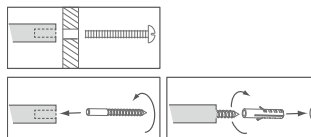

HZ6

HZ14

HZ16

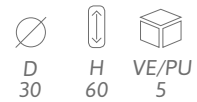

S154



Holz mit M4 Metallmuffe /  
wood with M4 metal thread

Bestellnummer | Order no.  
S154-50HZ1  
S154-50HZ6  
S154-50HZ16  
S154-50HZ17

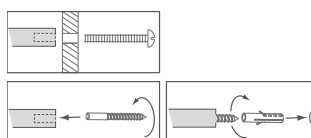

HZ1

HZ6

HZ16

HZ17



S121



Holz / wood

Bestellnummer | Order no.  
S121/HZ14



HZ14

				
L 153	B/W 58	H 65	LA/CC 131	VE/PU 5

S109



Holz mit M4 Metallmuffe /  
wood with M4 metal thread



Bestellnummer | Order no.  
S109/HZ6  
S109/HZ14



HZ6



HZ14

		
D 64	H 71	VE/PU 5



Abbildung: S109/HZ6, S70-35HZ6

---

# ZIERHAKEN

---

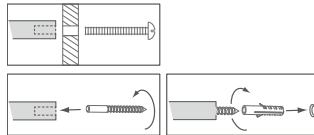
*Bei der Produktion unserer Haken und Zierhaken greifen wir auf bewährte Materialien – Metall, Edelstahl, Kunststoff und Holz – zurück und kombinieren diese auch gerne miteinander.*

*Die Haken eignen sich für den Einsatz in allen Wohnbereichen, von der Garderobe über die Küche bis hin zum Badezimmer und können je nach Wunsch direkt an der Wand oder als Ergänzung an bestehenden Möbelstücken montiert werden. Die erprobte Qualität des Materials und die sorgfältige Herstellung garantieren eine lange Haltbarkeit auch bei starker Beanspruchung.*

*Durch den Materialmix und die vielfältigen Ausführungen in Form und Farbe passen unsere Haken zu jedem Einrichtungsstil. Je nach persönlichem Geschmack können sie als schlichte und dezente Alltagshelfer, aber auch als bewusst eingesetzte Designelemente dienen.*

*Die ansprechenden Details wie handbemalte Oberflächen oder rustikale Verzierungen verstärken das Flair von traditionell eingerichteten Räumen, zeitlose Ausführungen in Edelstahl bieten die optimale Ergänzung für ein modernes Umfeld.*

---

# DECORATIVE HOOKS

---

*When manufacturing both our plain and decorative hooks, we make use of tried-and-tested materials – metal, stainless steel, plastic and wood – also combining them with one another.*

*The hooks are suitable for all living areas from the hallway to the kitchen, to the bathroom. They can be mounted directly onto the wall or added to existing items of furniture. The proven quality of the material and our meticulous production process mean that these products will last for many years – even used day-in, day-out.*

*The combination of materials and the many different colours and shapes of our designs ensure that you will find hooks to suit any interior – whether you are looking for subtle, everyday products or striking design features.*

*Beautiful details such as hand-painted surfaces or rustic embellishments highlight the flair of traditional rooms. And timeless design classics in stainless steel make for perfect additions to a modern living environment.*



1083



Druckguss / die cast

Passend zu 1082 Seite 149, 1185 Seite 148, 1265 Seite 317  
matching 1082 page 149, 1185 page 148, 1265 page 317

Bestellnummer | Order no.  
1083-78ZN29



ZN29

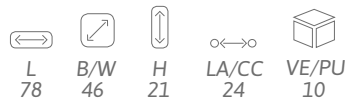

1076



Druckguss / die cast

Passend zu 1195, 1188, 1183, 1180 Seite 148, 1075, 1072 Seite 149  
matching 1195, 1188, 1183, 1180 page 148, 1075, 1072 page 149

Bestellnummer | Order no.  
1076-57ZN29



ZN29



1071



Druckguss / die cast

Passend zu 1195, 1188, 1183, 1180 Seite 148, 1075, 1072 Seite 149  
matching 1195, 1188, 1183, 1180 page 148, 1075, 1072 page 149

Bestellnummer | Order no.  
1071-58ZN29



ZN29

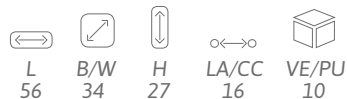

744



Druckguss mit M4 Gewinde /  
die cast with M4 thread

Passend zu 749, 1163 Seite 370  
matching 749, 1163 page 370

Bestellnummer | Order no.  
744/PB1  
744/PB7  
744/ZN1  
744/ZN2  
744/ZN5

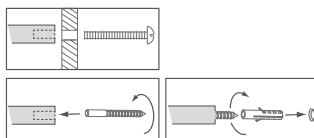

PB1

PB7

ZN1

ZN2



ZN5



584



Druckguss mit M4 Gewinde /  
die cast with M4 thread

○↔○ LOCHABSTAND | CENTER TO CENTER

☐ VERPACKUNGSEINHEIT | PACKING UNIT

∅ DURCHMESSER | DIAMETER

↔ LÄNGE (OBEN - UNTEN) | LENGTH (UP - DOWN)

↔ BREITE | WIDTH

☐ HÖHE (ABSTAND ZUR WAND) | HEIGHT (DISTANCE TO WALL)



579



Druckguss / die cast

Bestellnummer | Order no.  
 579-35ZN1  
 579-35ZN5  
 579-35ZN10  
 579-55ZN5  
 579-55ZN10



ZN1	ZN5	ZN10		
			↔	↗
L	B/W	H	↔↔	📦
36	17	17	LA/CC	VE/PU
55	26	28	11	10
			17	10

577



Druckguss / die cast

Bestellnummer | Order no.  
 577-45ZN8  
 577-65ZN8



ZN8				
	↔	↗	↔↔	📦
L	B/W	H	LA/CC	VE/PU
46	29	27	0	10
65	42	34	20	10

575



Druckguss / die cast

Bestellnummer | Order no.  
 575-45ZN5  
 575-45ZN10



ZN5	ZN10			
		↔	↗	↔↔
L	B/W	H	VE/PU	
47	25	29	10	



Abbildung: 577-45ZN8, 577-65ZN8

---

SELBSTKLEBENDE

# HAKEN UND HAKENLEISTEN

---

*Noch nie war die Montage so einfach wie mit unseren selbstklebenden Hakenleisten und edlen Klebehaken. SIRO setzt seit jeher auf hochwertige Klebeprodukte, sowohl bei kleineren Haken als auch bei Handtuch- und Schlüsselleisten sowie Türganlagen.*

*Durch die selbstklebende Rückseite können unsere Produkte ohne Werkzeuge schnell und einfach auf allen sauberen und glatten Oberflächen angebracht und bei Bedarf auch wieder rückstandslos entfernt werden. So kann im Handumdrehen Platz für zusätzliche Gebrauchsgegenstände oder Accessoires geschaffen werden.*

*Mit einem Belastungsgewicht von bis zu einem Kilo tragen die einzelnen Haken mühelos Geschirr- und Handtücher sowie einzelne Kleidungsstücke, was sie zu einem beliebten Helfer in vielen Wohnbereichen macht.*

---

SELFADHESIVE

# HOOKS AND HOOKRAILS

---

*With self-adhesive hook rails and hooks, mounting new purchases is easier than ever before. Each item makes use of the high-quality adhesives you would expect from SIRO – whether it is a small hook, towel rail, key holder or coat rack.*

*The adhesive backs mean that no tools are required. All you need is a clean and smooth surface and our products can be attached quickly and easily. The hooks can also be removed again without leaving a residue. With these products, space for additional items or accessories can be created in next to no time.*

*The hooks can carry up to one kilo in weight, meaning they can easily carry tea towels, bath towels or individual items of clothing – making them a handy addition to every living area.*



HAKEN UND HAKENLEISTEN SELBSTKLEBEND hooks and hookrails self-adhesive



2335 selbstklebend / self-adhesive



Druckguss / die cast

Bestellnummer | Order no.  
2335/PB21KV1B  
2335/ZN1KV1B  
2335/ZN21KV1B

Belastungsgewicht: max. 1 kg /  
loading weight: max. 1 kg



PB21 ZN1 ZN21

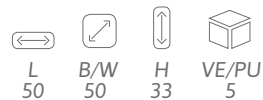

L 50 B/W 50 H 33 VE/PU 5

2334 selbstklebend / self-adhesive



Druckguss / die cast

Bestellnummer | Order no.  
2334/PB21KV1B  
2334/ZN1KV1B  
2334/ZN21KV1B

Belastungsgewicht: max. 1 kg /  
loading weight: max. 1 kg



PB21 ZN1 ZN21



L 50 B/W 43 H 33 VE/PU 5

2333 selbstklebend / self-adhesive



Druckguss / die cast

Bestellnummer | Order no.  
2333/ZN1KV1B  
2333/ZN4KV1B  
2333/ZN21KV1B

Belastungsgewicht: max. 1 kg /  
loading weight: max. 1 kg



ZN1 ZN4 ZN21

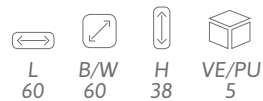

L 60 B/W 60 H 38 VE/PU 5

2332 selbstklebend / self-adhesive



Druckguss / die cast

Bestellnummer | Order no.  
2332/ZN1KV1B  
2332/ZN4KV1B  
2332/ZN21KV1B

Belastungsgewicht: max. 1 kg /  
loading weight: max. 1 kg



ZN1 ZN4 ZN21

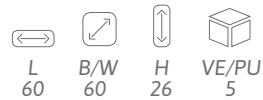

L 60 B/W 60 H 26 VE/PU 5

2331 selbstklebend / self-adhesive



Druckguss / die cast

Bestellnummer | Order no.  
2331/ZN1KV1B  
2331/ZN4KV1B  
2331/ZN21KV1B

Belastungsgewicht: max. 1 kg /  
loading weight: max. 1 kg



ZN1 ZN4 ZN21

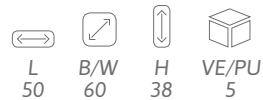

L 50 B/W 60 H 38 VE/PU 5

2330

selbstklebend / self-adhesive



Druckguss / die cast

Bestellnummer | Order no.  
2330/ZN1KV1B  
2330/ZN4KV1B  
2330/ZN21KV1B

Belastungsgewicht: max. 1 kg /  
loading weight: max. 1 kg



ZN1

ZN4

ZN21

L  
50

B/W  
50

H  
38

VE/PU  
5



Abbildung: 2330/ZN21KV1B

2322

selbstklebend / self-adhesive



Edelstahl / stainless steel

Bestellnummer | Order no.  
2322/N1KV1B

Belastungsgewicht: max. 0,5 kg /  
loading weight: max. 0,5 kg



N1



2321

selbstklebend / self-adhesive



Edelstahl / stainless steel

Bestellnummer | Order no.  
2321/N1KV3B\*

Belastungsgewicht: max. 0,3 kg /  
loading weight: max. 0,3 kg

\* Bestellnr. für 3 Stück / order no. for 3 pcs.  
VE / MOQ : 5 = 15 Stück / pieces



N1



2320

selbstklebend / self-adhesive



Edelstahl / stainless steel

Bestellnummer | Order no.  
2320/N1KV3B\*

Belastungsgewicht: max. 0,3 kg /  
loading weight: max. 0,3 kg

\* Bestellnr. für 3 Stück / order no. for 3 pcs.  
VE / MOQ : 5 = 15 Stück / pieces



N1



2319

selbstklebend / self-adhesive



Stahl / steel

Bestellnummer | Order no.  
2319/ZN1KV3B\*  
2319/ZN4KV3B\*

Belastungsgewicht: max. 0,3 kg /  
loading weight: max. 0,3 kg

\* Bestellnr. für 3 Stück / order no. for 3 pcs.  
VE / MOQ : 5 = 15 Stück / pieces



ZN1



ZN4



2178

selbstklebend / self-adhesive



Stahl / steel

Bestellnummer | Order no.  
2178/ZN1K  
2178/ZN4K

Belastungsgewicht: max. 0,5 kg /  
loading weight: max. 0,5 kg



ZN1



ZN4



Passend zu 1603 Seite 366, 2177 Seite 302, 2179, 2180 Seite 378  
matching 1603 page 366, 2177 page 302, 2179, 2180 page 378

↔ LOCHABSTAND | CENTER TO CENTER

📦 VERPACKUNGSEINHEIT | PACKING UNIT

⊘ DURCHMESSER | DIAMETER

↕ LÄNGE (OBEN - UNTEN) | LENGTH (UP - DOWN)

↔ BREITE | WIDTH

📏 HÖHE (ABSTAND ZUR WAND) | HEIGHT (DISTANCE TO WALL)

743 selbstklebend / self-adhesive



Druckguss / die cast

Passend zu 743 Seite 324  
matching 743 page 324



ZN1

L	B/W	H	VE/PU
37	28	32	10

Bestellnummer | Order no.  
743/ZN1K

Belastungsgewicht: max. 0,5 kg /  
loading weight: max. 0,5 kg

2303 selbstklebend / self-adhesive



Stahl / steel



ZN1

ZN4

L	B/W	H	LA/CC	VE/PU
240	41	32	210	5
366	41	32	336	5

Bestellnummer | Order no.  
2303-240ZN1KV1K  
2303-240ZN4KV1K  
2303-366ZN1KV1K  
2303-366ZN4KV1K

Belastungsgewicht: max. 10 kg /  
loading weight: max. 10 kg

L 240 = 6 Haken / hooks  
L 366 = 9 Haken / hooks

passend für alle Türstärken, selbstklebend oder schraubbar /  
suitable for all door thicknesses, self-adhesive or screwable

2178 selbstklebend / self-adhesive



Stahl / steel



ZN1

ZN4

L	B/W	H	VE/PU
72	41	16	5
114	41	16	5
156	41	16	5
240	41	16	5

Bestellnummer | Order no.  
2178-72ZN1KV1K  
2178-72ZN4KV1K  
2178-114ZN1KV1K  
2178-114ZN4KV1K  
2178-156ZN1KV1K  
2178-156ZN4KV1K  
2178-240ZN1KV1K  
2178-240ZN4KV1K

Belastungsgewicht / loading weight:  
2178-72: max. 0,5 kg  
2178-114, -156: max. 1 kg  
2178-240: max. 1,5 kg

L 72 = 2 Haken / hooks  
L 114 = 3 Haken / hooks  
L 156 = 4 Haken / hooks  
L 240 = 6 Haken / hooks

Passend zu 1603 Seite 366, 2177 Seite 302, 2179, 2180 Seite 378  
matching 1603 page 366, 2177 page 302, 2179, 2180 page 378



Abbildung: 2322/N1KV1B

H214 selbstklebend / self-adhesive



Kunststoff / plastic



Bestellnummer | Order no.  
 H214/A4KV3B\*  
 H214/A13KV3B\*  
 H214/A49KV3B\*

Belastungsgewicht: max. 0,3 kg /  
 loading weight: max. 0,3 kg

\* Bestellnr. für 3 Stück / order no. for 3 pcs.  
 VE / MOQ : 5 = 15 Stück / pieces



L 29	B/W 18	H 14	VE/PU 5

H199 selbstklebend / self-adhesive



Kunststoff - Softmaterial /  
 plastic - soft material

Passend zu H148 Seite 228  
 matching H148 page 228

Bestellnummer | Order no.  
 H199/A4RU2K

Belastungsgewicht: max. 0,3 kg /  
 loading weight: max. 0,3 kg



A4RU2

L 77	B/W 42	H 21	VE/PU 10

H198 selbstklebend / self-adhesive



Kunststoff - Softmaterial /  
 plastic - soft material

Passend zu H148 Seite 228  
 matching H148 page 228

Bestellnummer | Order no.  
 H198/A4RU2K

Belastungsgewicht: max. 0,6 kg /  
 loading weight: max. 0,6 kg



A4RU2

L 77	B/W 99	H 21	VE/PU 10

H114 selbstklebend / self-adhesive



Kunststoff / plastic

Bestellnummer | Order no.  
 H114/A4K  
 H114/A13K  
 H114/A49K

Belastungsgewicht: max. 0,3 kg /  
 loading weight: max. 0,3 kg



L 42	B/W 26	H 22	VE/PU 20

SP68 selbstklebend / self-adhesive



Keramik - Druckguss / ceramic - die cast

Bestellnummer | Order no.  
 SP68-45ZN1  
 SP68-60ZN1

Belastungsgewicht: max. 0,5 kg /  
 loading weight: max. 0,5 kg



ZN1

L 45 59	B/W 38 50	H 31 41	VE/PU 10 10





Abbildung: H214/A13KV3B

HAKEN UND HAKENLEISTEN SELBSTKLEBEND hooks and hookrails self-adhesive

---

# HAKENLEISTEN

---

*Unsere Hakenleisten sind in unterschiedlichen Längen und Ausführungen erhältlich und erfüllen somit sämtliche Ansprüche. Hakenleisten mit Einlegedekoren erlauben eine individuelle Gestaltung; durch die Verwendung von Verbindungs- und Endstücken passen sie sich neuen Gegebenheiten an und stehen für innovative Garderobekonzepte.*

*Unsere hochwertigen Hakenleisten sind aus Holz, Stahl oder Kunststoff hergestellt und bieten vielfältige Verwendungsmöglichkeiten – beispielsweise als Garderobenelemente, Handtuchhalter oder Schlüsselbrett.*

*Mit unseren Türgarderoben und -haken zum Einhängen kann auch bisher ungenutzter Platz optimal genutzt und Raum für Neues geschaffen werden.*

---

# HOOKRAILS

---

*Our hook rails are available in different lengths and styles, providing the optimal design solution for any space, while inlaid designs add that extra individual touch. Connections and end pieces make it easy to extend the rails, meaning more flexibility and options for innovative wardrobe solutions.*

*Our high-quality hook rails are made of wood, stainless steel or plastic and have many potential uses. They can be mounted as a wardrobe element or used to hang up towels or keep track of keys.*

*With our coat rails and hooks you can take advantage of forgotten corners and make space for something new.*



2452



Bestellnummer | Order no.  
2452-322PB1V1K  
2452-322PB12V1K

Stahl / steel

Passend zu 2453 Seite 290  
matching 2453 page 290



PB1

PB12



2430

Hakenleiste mit Ablage / hookrail with storage board



Bestellnummer | Order no.  
2430-513ZN1K1V1KF  
2430-513ZN4K1V1KF

Stahl - Gummi / steel - rubber



ZN1

ZN4

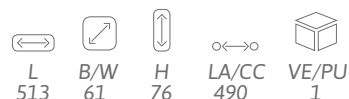

2323



Bestellnummer | Order no.  
2323-360ZN1A49V1B  
2323-360ZN4A81V1B

Stahl - Kunststoff / steel - plastic



ZN1A49

ZN4A81

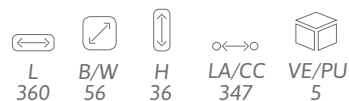

Passend zu 2081, 2081DM Seite 302, 2378 Seite 378  
matching 2081, 2081DM page 302 2378 page 378

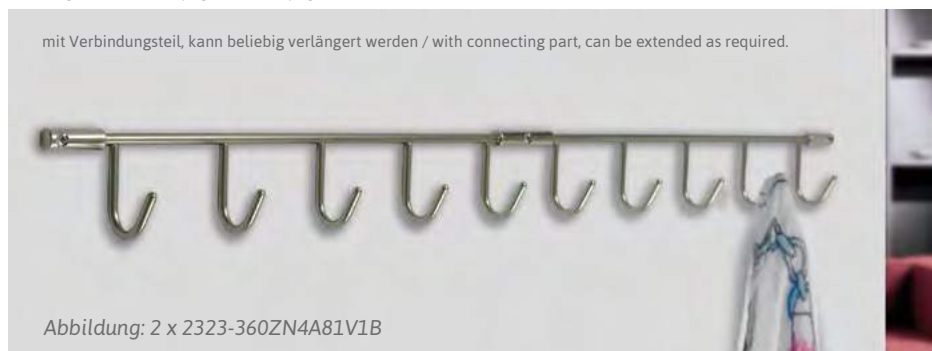

mit Verbindungsteil, kann beliebig verlängert werden / with connecting part, can be extended as required.

Abbildung: 2 x 2323-360ZN4A81V1B

2312



Bestellnummer | Order no.  
2312-320N1V1B

Edelstahl / stainless steel



N1

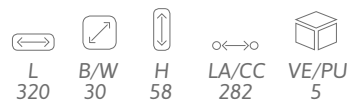

LOCHABSTAND | CENTER TO CENTER

VERPACKUNGSEINHEIT | PACKING UNIT

DURCHMESSER | DIAMETER

LÄNGE | LENGTH

BREITE | WIDTH

HÖHE | HEIGHT



Abbildung: 2430-513ZN1K1V1KF



Abbildung: 2312-320N1V1B

2305

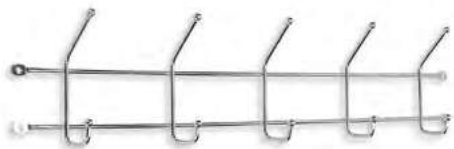

Stahl / steel

Bestellnummer | Order no.  
2305-516ZN1V1K



ZN1

L	B/W	H	LA/CC	VE/PU
516	105	48	506x46	5

2256



Edelstahl / stainless steel

Bestellnummer | Order no.  
2256-220N1V1K  
2256-300N1V1K  
2256-380N1V1K



N1

L	B/W	H	LA/CC	VE/PU
220	80	50	196	5
300	80	50	276	5
380	80	50	356	5

L 220 = 3 Haken / hooks  
L 300 = 4 Haken / hooks  
L 380 = 5 Haken / hooks

Passend zu 2258, 2259 Seite 336, 2257 Seite 378  
matching 2258, 2259 page 336, 2257 page 378

2255

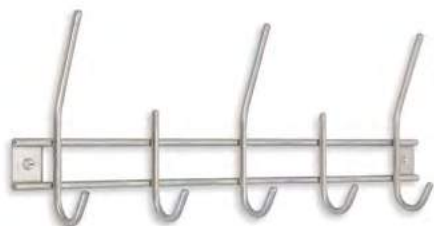

Edelstahl / stainless steel

Bestellnummer | Order no.  
2255-220N1V1K  
2255-380N1V1K



N1

L	B/W	H	LA/CC	VE/PU
220	138	50	196	5
380	138	50	356	5

L 220 = 3 Haken / hooks  
L 380 = 5 Haken / hooks

Passend zu 2258, 2259 Seite 336, 2257 Seite 378  
matching 2258, 2259 page 336, 2257 page 378

2226



Stahl / steel

Bestellnummer | Order no.  
2226-255ZN1BD18V1B



ZN1BD18

L	B/W	H	LA/CC	VE/PU
255	94	17	240	5



Your Design!

Hakenleiste mit 4 Stk. Einlegedekoren /  
hookrail with 4 pcs. decor inserts

2215



Stahl / steel

Bestellnummer | Order no.  
2215-485ZN1V1K



ZN1

L	B/W	H	LA/CC	VE/PU
485	100	45	467	5

2196



Edelstahl / stainless steel

Passend zu 2258, 2259 Seite 336, 2257 Seite 378  
 matching 2258, 2259 page 336, 2257 page 378

Bestellnummer | Order no.  
 2196-140N1V1K  
 2196-300N1V1K  
 2196-460N1V1K



N1

L	B/W	H	LA/CC	VE/PU
140	162	50	118	5
300	162	50	278	5
466	162	50	444	5

L 140 = 2 Haken / hooks  
 L 300 = 4 Haken / hooks  
 L 460 = 6 Haken / hooks

2165



Stahl - Kunststoff / steel - plastic

Bestellnummer | Order no.  
 2165-260PB12JE8V1K  
 2165-260ZN1JE7V1K



PB12JE8



ZN1JE7

L	B/W	H	LA/CC	VE/PU
260	90	50	155	5



Abbildung: 2256-380N1V1K

2088



Druckguss / die cast

Passend zu 1874 Seite 99  
matching 1874 page 99

Bestellnummer | Order no.  
2088-369ZN1V1K  
2088-369ZN10V1K



L	B/W	H	LA/CC	VE/PU
369	40	58	128	5

2083



Aluminium - Kunststoff / aluminium - plastic

Passend zu 2399 Seite 378  
matching 2399 page 378

Bestellnummer | Order no.  
2083-330AL1A4V1K  
2083-450AL1A4V1K



AL1A4

L	B/W	H	LA/CC	VE/PU
332	44	47	312	5
450	44	47	2x216	5

L 330 = 3 Haken / hooks  
L 450 = 4 Haken / hooks

2081



Stahl / steel

Passend zu 2081, 2081DM Seite 302  
matching 2081, 2081DM page 302

Bestellnummer | Order no.  
2081-200ZN1  
2081-272ZN1  
2081-350ZN1  
2081-420ZN1V1K



ZN1

L	B/W	H	LA/CC	VE/PU
200	53	32	189	5
272	53	32	262	5
350	53	32	339	5
420	51	32	410	5

L 200 = 3 Haken / hooks  
L 272 = 4 Haken / hooks  
L 350 = 5 Haken / hooks  
L 420 = 6 Haken / hooks

2081DM



Stahl / steel

Passend zu 2081, 2081DM Seite 302  
matching 2081, 2081DM page 302

Bestellnummer | Order no.  
2081DM-272ZN1V1E

zur Deckenmontage /  
for mounting on the ceiling

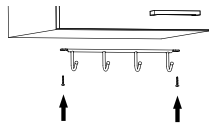

ZN1

L	B/W	H	LA/CC	VE/PU
272	51	35	262	5

L 272 = 4 Haken / hooks

2077



Stahl / steel

Bestellnummer | Order no.  
2077-321ZN1V1K  
2077-321ZN4V1K

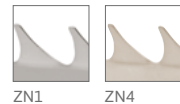

ZN1

ZN4

L	B/W	H	LA/CC	VE/PU
321	54	25	298	5



1890



Bestellnummer | Order no.  
1890-322N1V1K

Edelstahl / stainless steel



N1

L 322	B/W 39	H 46	LA/CC 298	VE/PU 5

1891

Endstück und Verbindungsstück für Hakenleiste 1890 /  
end cap and connecting element for hookrail 1890



Edelstahl / stainless steel



Bestellnummer | Order no.

Endstück / end cap  
1891-39N1V2K\*

Verbindungsstück / connecting element  
1891-52N1V1K

\* Bestellnr. für 2 Stück / order no. for 2 pcs.  
VE / MOQ : 5 = 10 Stück / pieces



N1

L *39 52	B/W 40 40	H 8 8	LA/CC 0 26	VE/PU 5 5



Abbildung: 1 x 1891-39N1V2K, 4 x 1890-322N1V1K, 3 x 1891-52N1V1K

1875

In Holland, Belgien und Deutschland nicht lieferbar / Not available in Netherland, Belgium and Germany



Bestellnummer | Order no.  
1875-210AL1  
1875-360AL1V1K

Aluminium / aluminium



AL1

L	B/W	H	LA/CC	VE/PU
210	35	34	190	5
360	35	34	240	5

L 210 = 3 Haken / hooks  
L 360 = 5 Haken / hooks

1783



Bestellnummer | Order no.  
1783-300PB21VIP  
1783-400PB21V1P

Stahl / steel



PB21

L	B/W	H	LA/CC	VE/PU
300	145	83	2x130	5
400	145	83	2x180	5

L 300 = 3 Haken / hooks  
L 400 = 4 Haken / hooks

Passend zu 1463 Seite 311  
matching 1463 page 311

1674



Bestellnummer | Order no.  
1674-320AL1A4V1K  
1674-550AL1A4V1K

Aluminium - Kunststoff / aluminium - plastic



AL1A4

L	B/W	H	LA/CC	VE/PU
324	120	80	302	5
550	120	80	208/116	5

L 320 = 2 Hut- und 1 Mantelhaken / 2 hat- and 1 coat hooks  
L 550 = 3 Hut- und 2 Mantelhaken / 3 hat- and 2 coat hooks

1673



Bestellnummer | Order no.  
1673-330AL1A4V1K  
1673-450AL1A4V1K

Aluminium - Kunststoff / aluminium - plastic



AL1A4

L	B/W	H	LA/CC	VE/PU
332	120	80	312	5
450	120	80	2x216	5

L 330 = 3 Haken / hooks  
L 450 = 4 Haken / hooks

1603



Bestellnummer | Order no.  
1603-114ZN1  
1603-114ZN4  
1603-240ZN1  
1603-240ZN4  
1603-366ZN1V1K  
1603-366ZN4V1K

Stahl / steel



ZN1



ZN4

L	B/W	H	LA/CC	VE/PU
114	41	16	84	5
240	41	16	210	5
366	41	16	336	5

L 114 = 3 Haken / hooks  
L 240 = 6 Haken / hooks  
L 366 = 9 Haken / hooks

Passend zu 2177 Seite 302, 2178 Seite 354, 2179, 2180 Seite 378  
matching 2177 page 302, 2178 page 354, 2179, 2180 page 378

LOCHABSTAND | CENTER TO CENTER

VERPACKUNGSEINHEIT | PACKING UNIT

DURCHMESSER | DIAMETER

LÄNGE | LENGTH

BREITE | WIDTH

HÖHE | HEIGHT

1464



Stahl / steel

Passend zu 1463 Seite 311  
matching 1463 page 311

Bestellnummer | Order no.  
1464-360ZN4V1P  
1464-560ZN4V1P



ZN4

L	B/W	H	LA/CC	VE/PU
365	126	87	300	5
562	126	87	497	5

L 360 = 3 Haken / hooks  
L 560 = 5 Haken / hooks

1444



Stahl / steel

Passend zu 1443 Seite 380  
matching 1443 page 380

Bestellnummer | Order no.  
1444-404ZN1V1K  
1444-404ZN4V1K



ZN1



ZN4

L	B/W	H	LA/CC	VE/PU
404	51	33	368	5



Abbildung: 1464-360ZN4V1P

1411



Stahl / steel

Passend zu 1410 Seite 381  
matching 1410 page 381

Bestellnummer | Order no.  
1411-255ZN4



ZN4

L 255	B/W 90	H 15	LA/CC 240	VE/PU 5

1355



Stahl / steel

Bestellnummer | Order no.  
1355-255ZN4



ZN4

L 253	B/W 179	H 15	LA/CC 210	VE/PU 5

1334



Stahl / steel

Bestellnummer | Order no.  
1334-500PB1



PB1

L 500	B/W 167	H 28	LA/CC 316	VE/PU 5

1295



Stahl - Holz / steel - wood

Passend zu 1292, 1293 Seite 315, 1294 Seite 314, 1296 Seite 381  
matching 1292, 1293 page 315, 1294 page 314, 1296 page 381

Bestellnummer | Order no.  
1295-412PB18HZ34  
1295-412PB19HZ34



PB18HZ34



PB19HZ34

L 412	B/W 124	H 102	LA/CC 348	VE/PU 5

1290



Stahl - Holz / steel - wood

Passend zu 1292, 1293 Seite 315, 1294 Seite 314, 1296 Seite 381  
matching 1292, 1293 page 315, 1294 page 314, 1296 page 381

Bestellnummer | Order no.  
1290-450PB18HZ34  
1290-450PB19HZ34



PB18HZ34



PB19HZ34

L 452	B/W 135	H 127	LA/CC 388	VE/PU 5

LOCHABSTAND | CENTER TO CENTER

VERPACKUNGSEINHEIT | PACKING UNIT

DURCHMESSER | DIAMETER

LÄNGE | LENGTH

BREITE | WIDTH

HÖHE | HEIGHT

1135



PB1



Bestellnummer | Order no.  
1135-200PB1  
1135-270PB1

L	B/W	H	LA/CC	VE/PU
201	20	31	181	5
271	20	31	251	5

Aluminium / aluminium

L 200 = 3 Haken / hooks  
L 270 = 4 Haken / hooks



1163



Bestellnummer | Order no.  
1163-460HZ42ZN5

Druckguss - Holz / die cast - wood

Passend zu 744 Seite 348  
matching 744 page 348



HZ42ZN5

L 460	B/W 58	H 43	LA/CC 312	VE/PU 5

1161



Bestellnummer | Order no.  
1161-500HZ18ZN2  
1161-500HZ42ZN2

Druckguss - Holz / die cast - wood

Passend zu 1096, 1097 Seite 322  
matching 1096, 1097 page 322



HZ18ZN2



HZ42ZN2

L 500	B/W 157	H 92	LA/CC 396	VE/PU 5

1024



Bestellnummer | Order no.  
1024-200HZ17ZN5

Druckguss - Holz / die cast - wood

Passend zu 744 Seite 348  
matching 744 page 348



HZ17ZN5

L 200	B/W 40	H 40	LA/CC 170	VE/PU 5

749



Bestellnummer | Order no.  
749-300HZ6ZN5  
749-300HZ14ZN5  
749-300HZ21PB1  
749-300HZ21ZN1  
749-300HZ21ZN5

Druckguss - Holz / die cast - wood

Passend zu 744 Seite 348  
matching 744 page 348



HZ6ZN5



HZ14ZN5



HZ21PB1



HZ21ZN1



HZ21ZN5

L 300	B/W 36	H 38	LA/CC 270	VE/PU 5

618



Bestellnummer | Order no.  
618-500HZ14ZN8  
618-500HZ14ZN10

Druckguss - Holz / die cast - wood

Passend zu 504 Seite 329  
matching 504 page 329



HZ14ZN8



HZ14ZN10

L 500	B/W 152	H 76	LA/CC 396	VE/PU 5

LOCHABSTAND | CENTER TO CENTER

VERPACKUNGSEINHEIT | PACKING UNIT

DURCHMESSER | DIAMETER

LÄNGE | LENGTH

BREITE | WIDTH

HÖHE | HEIGHT



Abbildung: 1161-500HZ18ZN2

01047



Kunststoff - Druckguss / plastic - die cast

Bestellnummer | Order no.  
 01047-248K1ZN1V1K  
 01047-248K60ZN1V1K  
 01047-248MV11ZN1V1K

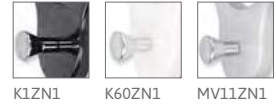

L	B/W	H	LA/CC	VE/PU
248	103	31	2x100	5

0970

An die Caravan-Industrie nicht lieferbar / Not available for caravan industry



Kunststoff / plastic

Bestellnummer | Order no.  
 0970-103MV11



MV11

L	B/W	H	LA/CC	VE/PU
103	50	23	40	5

0841



Kunststoff / plastic

Bestellnummer | Order no.  
 0841-400K10K10V1K  
 0841-400MF18K77V1K



K10K10 MF18K77

L	B/W	H	LA/CC	VE/PU
400	100	75	376	5

0464



Kunststoff / plastic

Bestellnummer | Order no.  
 0464/K10  
 0464/MV7  
 0464/MV10

0464/K10PZN5  
 Kunststoff - Druckguss  
 plastic - die cast



K10 K10PZN5 MV7 MV10

L	B/W	H	LA/CC	VE/PU
240	36	29	208	5

H205



Kunststoff / plastic

Bestellnummer | Order no.  
 H205-350A123A4V1K  
 H205-350A124A4V1K



A123A4 A124A4

L	B/W	H	LA/CC	VE/PU
350	90	64	130	5





Abbildung: 01047-248K60ZN1V1K, 01047-248MV11ZN1V1K, 01047-248K1ZN1V1K

H190 handbemalt / hand painted



Kunststoff / plastic

Bestellnummer | Order no.  
H190-166A9V1B



A9

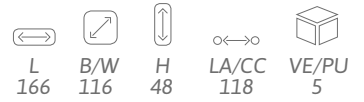

H184 handbemalt / hand painted



Kunststoff / plastic

Bestellnummer | Order no.  
H184-124A9V1B



A9

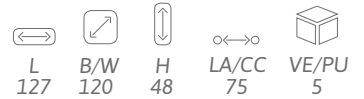

SM8177



Kunststoff / plastic

Bestellnummer | Order no.  
SM8177-300BDJ1  
SM8177-300BDJ2



BDJ1

BDJ2

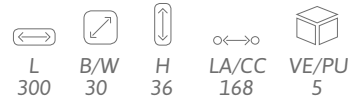

Passend zu SM8004 Seite 252  
matching SM8004 page 252

SM8164



Kunststoff / plastic

Bestellnummer | Order no.  
SM8164-400CP2MV7V1K  
SM8164-400CP34MT1V1K  
SM8164-400K10MT1V1K  
SM8164-400MV2MT1V1K



CP2MV7

CP34MT1

K10MT1

MV2MT1

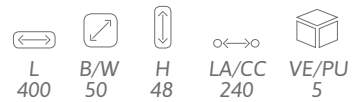

SM8163



Kunststoff / plastic

Bestellnummer | Order no.  
SM8163-400MV2AC1V1K  
SM8163-400MV2AC14V1K



MV2AC1

MV2AC14

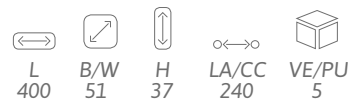

SM8162



Bestellnummer | Order no.  
SM8162-300K10K10  
SM8162-300SN13MV106

Kunststoff / plastic



L	B/W	H	LA/CC	VE/PU
300	30	35	168	5

SM8161



Bestellnummer | Order no.  
SM8161-300K10K10  
SM8161-300SN13MV106  
SM8161-300SN26MV106

Kunststoff / plastic



L	B/W	H	LA/CC	VE/PU
300	32	30	168	5



Abbildung: SM8177-300BDJ2

S668



Holz / wood

Bestellnummer | Order no.  
S668-480HZ69V1P



HZ69

L	B/W	H	LA/CC	VE/PU
480	26	36	420	5

S662



Holz / wood

Bestellnummer | Order no.  
S662-390HZ5V1K  
S662-390HZ68V1K  
S662-520HZ66V1K  
S662-520HZ67V1K



HZ5



HZ66



HZ67



HZ68

L	B/W	H	LA/CC	VE/PU
390	40	62	360	5
520	40	62	490	5

L 390 = 3 Haken / hooks  
L 520 = 4 Haken / hooks

S660



Holz / wood

Bestellnummer | Order no.  
S660-155HZ17V1P  
S660-260HZ17V1P  
S660-435HZ17V1P



HZ17

L	B/W	H	LA/CC	VE/PU
155	35	26	104	5
260	35	26	139	5
435	35	26	314	5

L 155 = 5 Haken / hooks  
L 260 = 8 Haken / hooks  
L 435 = 13 Haken / hooks

S641



Holz / wood

Bestellnummer | Order no.  
S641-280HZ46  
S641-420HZ6



HZ6



HZ46

L	B/W	H	LA/CC	VE/PU
280	28	48	250	5
420	28	48	390	5

L 280 = 4 Haken / hooks  
L 420 = 6 Haken / hooks

S307



Holz / wood

Bestellnummer | Order no.  
S307-460HZ16



HZ16

L	B/W	H	LA/CC	VE/PU
460	45	65	430	5

S126



Bestellnummer | Order no.  
 S126-270HZ5  
 S126-460HZ5V1K  
 S126-460HZ17

Holz / wood



HZ5

HZ17

L	B/W	H	LA/CC	VE/PU
270	60	77	162	5
460	58	77	312	5

L 270 = 3 Haken / hooks  
 L 460 = 5 Haken / hooks

S124



Bestellnummer | Order no.  
 S124-300HZ5  
 S124-300HZ6

Holz / wood



HZ5

HZ6

L	B/W	H	LA/CC	VE/PU
300	47	38	162	5



HZ5

HZ17

Bestellnummer | Order no.  
 S123-300HZ5  
 S123-460HZ5V1K  
 S123-460HZ17

Holz / wood

L	B/W	H	LA/CC	VE/PU
300	47	74	162	5
460	47	74	324	5

L 300 = 4 Haken / hooks  
 L 460 = 6 Haken / hooks



Abbildung: S123-460HZ5V1K

2399



Aluminium - Kunststoff / aluminium - plastic

Bestellnummer | Order no.  
2399-486ALIA4V1K

17 mm Tür / door

Passend zu 2083 Seite 364  
matching 2083 page 364



ALIA4

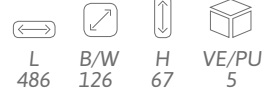

2378



Stahl / steel

Bestellnummer | Order no.  
2378-355ZN1V1K

17 mm Tür / door

Passend zu 2081, 2081DM Seite 302, 2323 Seite 360  
matching 2081, 2081DM page 302, 2323 page 360



ZN1



2257

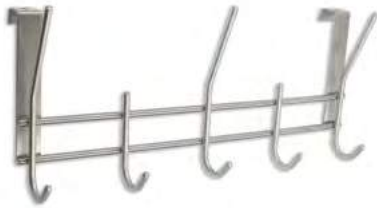

Edelstahl / stainless steel

Bestellnummer | Order no.  
2257-340N1V1K

17 mm Tür / door

Passend zu 2258, 2259 Seite 336, 2256, 2255 Seite 362, 2196 Seite 363  
matching 2258, 2259 page 336, 2256, 2255 page 362, 2196 page 363



N1



2180



Stahl / steel

Bestellnummer | Order no.  
2180-100ZN1V3B\*

17 mm Tür / door

Passend zu 2178 Seite 354, 2177 Seite 302  
matching 2178 page 354, 2177 page 302

\* Bestellnr. für 3 Stück / order no. for 3 pcs.  
VE / MOQ : 5 = 15 Stück / pieces



ZN1

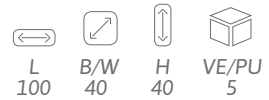

2179



Stahl / steel

Bestellnummer | Order no.  
2179-60ZN1V5B\*

17 mm Tür / door

Passend zu 2178 Seite 354, 2177 Seite 302  
matching 2178 page 354, 2177 page 302

\* Bestellnr. für 5 Stück / order no. for 5 pcs.  
VE / MOQ : 5 = 25 Stück / pieces



ZN1

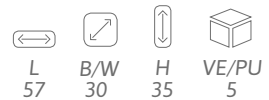

2144



Stahl / steel

40 mm Tür / door

Passend zu 2178 Seite 354, 2177 Seite 302, 1603 Seite 366  
matching 2178 page 354, 2177 page 302, 1603 page 366



ZN1

L	B/W	H	VE/PU
255	77	59	5
375	77	59	5

L 255 = 4 Haken / hooks  
L 375 = 6 Haken / hooks

2143



Stahl / steel

40 mm Tür / door

Bestellnummer | Order no.  
2143-404ZN1



ZN1

L	B/W	H	VE/PU
404	138	75	5



Abbildung: 2399-486AL1A4V1K

1983



Edelstahl / stainless steel

Bestellnummer | Order no.  
1983-135N1V1K

15 mm Tür / door



N1

L	B/W	H	VE/PU
135	30	59	5

1977



Stahl / steel

Bestellnummer | Order no.  
1977-255ZN1V1K  
1977-255ZN4V1K  
1977-375ZN1V1K  
1977-375ZN4V1K

17 mm Tür / door



ZN1

ZN4

L	B/W	H	VE/PU
255	100	38	5
375	100	38	5

L 255 = 4 Haken / hooks  
L 375 = 6 Haken / hooks

1829



Stahl - Holz / steel - wood

Bestellnummer | Order no.  
1829-490ZN1HZ34V1K

32 mm Tür / door



ZN1HZ34

L	B/W	H	LA/CC	VE/PU
500	225	85	480	5

1443



Stahl / steel

Bestellnummer | Order no.  
1443-404ZN1V1K  
1443-404ZN4V1K

17 mm Tür / door



ZN1

ZN4

L	B/W	H	VE/PU
404	136	56	5

Passend zu 1444 Seite 367  
matching 1444 page 367

1413



Stahl / steel

Bestellnummer | Order no.  
1413-92ZN1  
1413-92ZN4

17 mm Tür / door



ZN1

ZN4

L	B/W	H	VE/PU
92	68	36	5



1412



Stahl / steel

17 mm Tür / door

Bestellnummer | Order no.  
1412-79ZN1  
1412-79ZN4



ZN1

ZN4

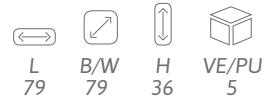

L  
79

B/W  
79

H  
36

VE/PU  
5

1410



Stahl / steel

17 mm Tür / door

Bestellnummer | Order no.  
1410-255ZN1  
1410-255ZN4V1K



ZN1

ZN4

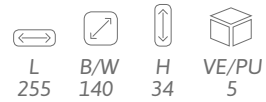

L  
255

B/W  
140

H  
34

VE/PU  
5

Passend zu 1411 Seite 368  
matching 1411 page 368

1296

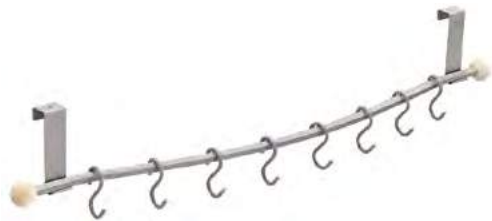

Stahl - Holz / steel - wood

17 mm Tür / door

Bestellnummer | Order no.  
1296-650PB18HZ34  
1296-650PB19HZ34



PB18HZ34

PB19HZ34

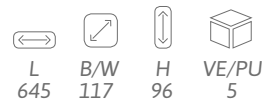

L  
645

B/W  
117

H  
96

VE/PU  
5

Passend zu 1290 Seite 368, 1292, 1293 Seite 315, 1294 Seite 314, 1295 Seite 368  
matching 1290 page 368, 1292, 1293 page 315, 1294 page 314, 1295 page 368



Abbildung: 1443-404ZN1V1K

01007



Kunststoff / plastic

Bestellnummer | Order no.  
01007-396K10K10V1K  
01007-396MF18K77V1K  
01007-396MF18KGA3V1K

17 mm Tür / door



K10K10 MF18K77 MF18KGA3

L 396	B/W 160	H 98	VE/PU 5

MI687

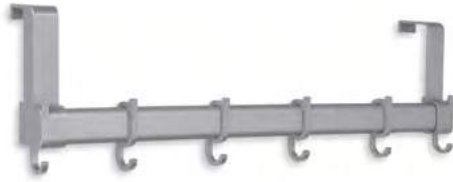

Kunststoff / plastic

Bestellnummer | Order no.  
MI687-480K90V1K  
MI687-575K2V1K  
MI687-575K10V1K  
MI687-575K90V1K

17 mm Tür / door



K2 K10 K90

L 480 590	B/W 139 139	H 60 60	VE/PU 5 5

L 480 = 6 Haken / hooks  
L 590 = 7 Haken / hooks

MI687



Kunststoff / plastic

Bestellnummer | Order no.  
MI687/K10V5E\*

5 Stk. Zusatzhaken für Hakenleiste MI687-575K10 /  
5 pcs. additional hooks for hookrail MI687-575K10

\* Bestellnr. für 5 Stück / order no. for 5 pcs.  
VE / MOQ : 10 = 50 Stück / pieces



K10

L 63	B/W 6	H 24	VE/PU 10

1996



Stahl - Gummi / steel - rubber

Bestellnummer | Order no.  
1996-300ZN1K1V1K  
1996-300ZN4K1V1K



ZN1K1 ZN4K1

L 300	B/W 150	H 75	LA/CC 250	VE/PU 5

H206



Kunststoff - Stahl / plastic - steel

Bestellnummer | Order no.  
H206/A3ZN1V1B

für Türen von 1900 - 2080 mm Höhe /  
for doors from 1900 - 2080 mm height

Haken höhenverstellbar /  
hooks height adjustable



A3ZN1

L 2080	B/W 25	H 37	VE/PU 5



Abbildung: H206/A3ZN1V1B



Abbildung: M1687-575K90V1K

---

# SONDERARTIKEL

---

*Mit unseren Sonderartikeln bieten wir eine zusätzliche Auswahl an Produkten, die unser umfangreiches Sortiment abrunden.*

*Besonders hervorzuheben sind hierbei unsere Styling Panels, vielseitig einsetzbare Wandelemente, die sich einfach montieren und dem persönlichen Geschmack entsprechend gestalten lassen. Sie können mit den mitgelieferten Klebepunkten oder mit handelsüblichem Montagekleber direkt an der Wand angebracht werden. Außerdem lassen sie sich auf die gewünschte Größe zuschneiden und mit Dispersionsfarbe bemalen oder sprühlackieren. Der eigenen Fantasie sind somit keine Grenzen gesetzt und schlichte Wände können zum absoluten Blickfang werden.*

*Produkte für den täglichen Gebrauch, wie hochwertige Handtuch- oder Krawattenhalter, Kleiderbügel, Türstopper, Schirmständer und Besenhalter erfüllen auch die höchsten Qualitätsansprüche unserer Kunden.*

*Darüber hinaus bieten wir spezielle Kunststoffgriffe, die besonders für die Anbringung an Glastüren geeignet sind. Außerdem kann für alle Produkte aus einem ausgewählten Sortiment an Zubehör, wie Kabeldurchlässen und Schrauben für die Montage, gewählt werden. Dekorative Zierbeschläge und ausgefallene Schlüsselschilder mit dazu passenden Schlüsseln vervollständigen das Angebot.*

---

# SPECIAL ITEMS

---

*Our additional items complete our extensive product range.*

*As a company, we are particularly proud of our Styling Panels. These versatile wall elements are easy to mount and adapt to your personal style. They can be attached directly to the wall using either the adhesive dots provided or a commercial assembly adhesive. You can cut them down to the required size and add colour with emulsion or spray paint. In terms of design, the sky's the limit. These products transform a simple white wall into an absolute eye-catcher.*

*All our everyday products, such as our high-quality towel rails or tie racks, hangers, doorstoppers, umbrella stands and broom racks, fulfil the high expectations of our exacting customers.*

*In addition, we offer special synthetic handles that are ideal for attaching onto glass doors. All products can be combined with a selected range of additional mounting products such as cable outlets and screws. Our decorative fittings and unusual keyhole covers with matching keys complete the range.*

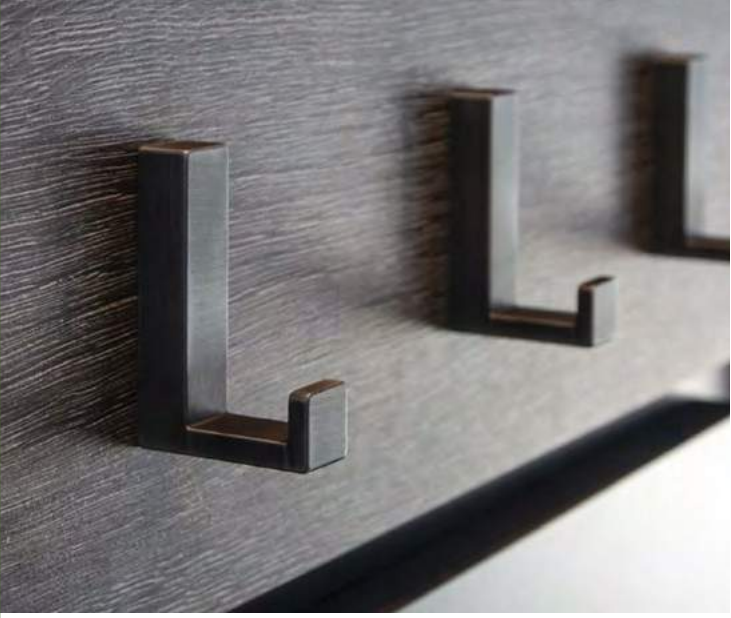

2459 Garderobenelement / wardrobe element



Bestellnummer | Order no.  
2459-250PB12PB12  
2459-250ZN27ZN27

Druckguss / die cast

Passend zu 2457, 2464 Seite 42, 2462, 2463 Seite 290  
matching 2457, 2464 page 42, 2462, 2463 page 290



PB12PB12



ZN27ZN27

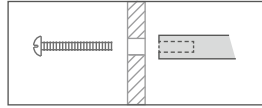

L 250	B/W 12	H 60	VE/PU 10

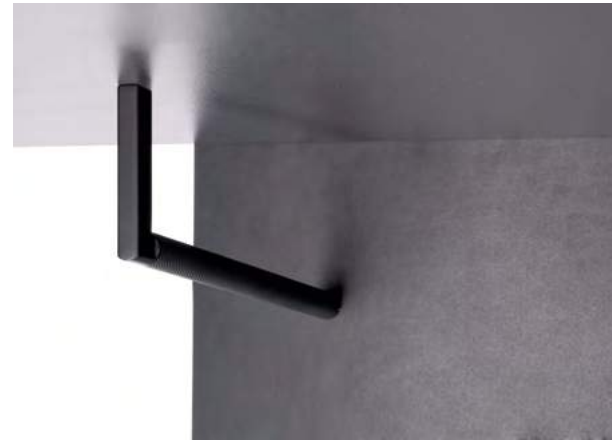

2429 Schirmständer für Wandmontage / wall-mounted umbrella stand



Bestellnummer | Order no.  
2429/ZN21K1PV1KF  
2429/ZN75K1PV1KF  
2429/ZN79K1PV1KF

Zamak - Kunststoff / zamac - plastic



ZN21



ZN75



ZN79

L 257	B/W 225	H 2x33	LA/CC 2x128	VE/PU 1



2422 Metallhaken mit Türstopper / metal hook with doorstop



Bestellnummer | Order no.  
2422/ZN1A3  
2422/ZN21A3

Druckguss - Kunststoff / die cast - plastic



ZN1A3



ZN21A3

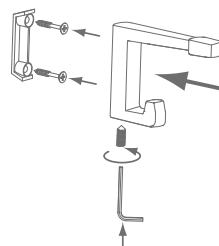

L 64	B/W 15	H 100	LA/CC 32	VE/PU 5



LOCHABSTAND | CENTER TO CENTER

LÄNGE | LENGTH

VERPACKUNGSEINHEIT | PACKING UNIT

BREITE | WIDTH

DURCHMESSER | DIAMETER

HÖHE | HEIGHT



Abbildung: 2429/ZN75K1PV1KF



Abbildung: 2422/ZN21A3

2390 Gardarobenelement / wardrobe element



Bestellnummer | Order no.  
2390-400ZN21V1KF  
2390-400ZN75V1KF  
2390-400ZN79V1KF

Stahl / steel



ZN21

ZN75

ZN79



2236F Gardarobenelement / wardrobe element



Bestellnummer | Order no.  
2236F-251N1V1K\*

Edelstahl mit M4 x 10 mm Gewinde /  
stainless steel with M4 x 10 mm thread



N1



2235F Gardarobenelement / wardrobe element



Bestellnummer | Order no.  
2235F/N1V3B\*

Edelstahl mit M4 x 10 mm Gewinde /  
stainless steel with M4 x 10 mm thread

\* Bestellnr. für 3 Stück /  
order no. for 3 pcs.  
VE / MOQ : 5 = 15 Stück / pieces



N1

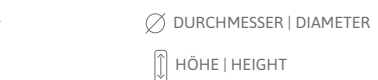

LOCHABSTAND | CENTER TO CENTER

VERPACKUNGSEINHEIT | PACKING UNIT

DURCHMESSER | DIAMETER

LÄNGE | LENGTH

BREITE | WIDTH

HÖHE | HEIGHT





Abbildung: 2390-400ZN75V1KF



Abbildung: 2236F-51N1V1K\*, 2235F/N1V3B\*

2431 Magnetische Kreidetafel mit Hakenleiste / magnetic chalkboard with hookrail



Bestellnummer | Order no.  
2431-254FE13ZN1V1KF  
2431-380FE13ZN1V1KF

inkl. Kreidehalter, Kreide und 10 Stk. Magnete /  
incl. chalk holder, chalk and 10 pcs. magnets

Stahl - Kunststoff / steel - plastic



FE13ZN1

L	B/W	H	LA/CC	VE/PU
254	384	19	210x336	1
380	258	19	336x210	1



2361 Gerätehalter / device holder



Bestellnummer | Order no.  
2361-50PB1A3V1P

Für Durchmesser von 20 - 35 mm /  
For diameter from 20 - 35 mm

Stahl - Kunststoff / steel - plastic



PB1A3

L	B/W	H	LA/CC	VE/PU
50	51	44	38	12



2352 Schrankverriegelung / cupboard locking



Bestellnummer | Order no.  
2352-58ZN1A139  
2352-58ZN16A139  
2352-58ZN21A139

Rastet beim Verschließen automatisch ein. Einfaches Öffnen durch das Betätigen des Verriegelungshebels.  
Snaps automatically by locking. Easily open by pressing the locking lever.

Druckguss - Kunststoff / die cast - plastic



ZN1A139

ZN16A139

ZN21A139

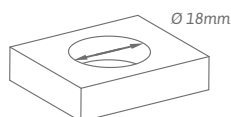

Ø 18mm

L	B/W	H	LA/CC	VE/PU
58	44	25	32	10



⇔ LOCHABSTAND | CENTER TO CENTER

☐ VERPACKUNGSEINHEIT | PACKING UNIT

∅ DURCHMESSER | DIAMETER

⇔ LÄNGE | LENGTH

☐ BREITE | WIDTH

☐ HÖHE | HEIGHT



Abbildung: 2431-254FE13ZN1V1KF



Abbildung: 2352-58ZN1A139



## STYLING PANELS

VIELSEITIG EINSETZBAR . VERSATILE USE

01086



Verkaufsverpackung /  
sales unit



Kunststoff / plastic



K87

			
L 250	B/W 250	H 15	VE/PU 1

Bestellnummer | Order no.  
01086-250K87PKV16\*

\* Packungsinhalt: 16 Stk. = 1m<sup>2</sup> . contents: 16 pieces = 1m<sup>2</sup>  
inkl. Klebepads / incl. adhesive pads



## KLEBEN . MALEN . FERTIG

EINFACH MONTIERT . EASY INSTALLATION

01085



Verkaufsverpackung /  
sales unit



Kunststoff / plastic



K87

			
L 250	B/W 250	H 7	VE/PU 1

Bestellnummer | Order no.  
01085-250K87PKV16\*

\* Packungsinhalt: 16 Stk. = 1m<sup>2</sup> . contents: 16 pieces = 1m<sup>2</sup>  
inkl. Klebepads / incl. adhesive pads

 LOCHABSTAND | CENTER TO CENTER

 LÄNGE | LENGTH

 VERPACKUNGSEINHEIT | PACKING UNIT

 BREITE | WIDTH

 DURCHMESSER | DIAMETER

 HÖHE | HEIGHT

2300 Handtuchhalter / towel rail



Druckguss / die cast

Passend zu 2183 Seite 70  
matching 2183 page 70

Bestellnummer | Order no.  
2300-380ZN1

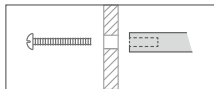

ZN1



L  
380



B/W  
10



H  
58



LA/CC  
48



VE/PU  
10

2299 Handtuchhalter / towel rail



Druckguss / die cast

Passend zu 2267 Seite 64  
matching 2267 page 64

Bestellnummer | Order no.  
2299-380ZN1

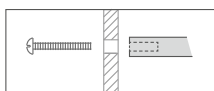

ZN1



L  
380



B/W  
10



H  
49



LA/CC  
48



VE/PU  
10

2142 Handtuchhalter / towel rail



Aluminium / aluminium

Passend zu 2110 Seite 78  
matching 2110 page 78

Bestellnummer | Order no.  
2142-300ZN1  
2142-380ZN1

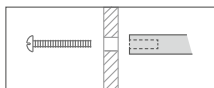

ZN1



L  
300  
380



B/W  
10  
10



H  
50  
50



LA/CC  
48  
48



VE/PU  
10  
10



Abbildung: 2299-380ZN1





# STORAGE BOX

Aufbewahrungssystem

## BAD, KÜCHE, WOHNWAGEN & Co.

Das Aufbewahrungssystem von SIRO hilft immer und überall Ordnung zu halten. Die Storage Boxen sind universell einsetzbar, egal ob Bad, Küche, Wohn- und Kinderzimmer, Home Office und dergleichen.

Auch im Reisemobil und Caravanssektor bewähren sich die praktischen Boxen, als hilfreiches Zubehör.

Die Storage Boxen bieten vielfache Einsatzmöglichkeiten. Mittels Montageclips an der Wand montiert oder einfach platzsparend gestapelt. Anti-Rutsch-Noppen sorgen stets für sicheren Halt in Schubkästen und auf Arbeitsplatten.

## BATH, KITCHEN, CARAVAN & Co.

SIRO's storage system helps to keep things in order all the time, in any place. The storage boxes can be used anywhere, whether in the bathroom, kitchen, living room, nursery, home office – anywhere you can think of.

Even in the mobile home and caravan sector these practical boxes are proving themselves as useful accessories.

The storage boxes offer many different uses. Using our "mounting clips", they can be fixed to the wall or they can simply be stacked to save space. Anti-slip nubs ensure a secure grip in drawers and on worksurfaces.

01094 Storage Box

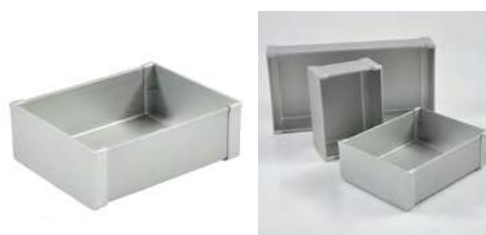

Kunststoff / plastic

Bestellnummer | Order no.

01094-90K39K1V2\*

01094-90RP85MV11V2\*

01094-160K39K1V2\*

01094-160RP85MV11V2\*

01094-250K39K1V2\*

01094-250RP85MV11V2\*

\* Bestellnr. für 2 Stück / order no. for 2 pcs.  
VE / MOQ : 1 = 2 Stück / pieces



K39K1



RP85MV11

L	B/W	H	VE/PU
90	127	56	1
160	127	56	1
250	127	56	1

H215 Klip für Storage Box / clip for storage box



Kunststoff / plastic

Bestellnummer | Order no.

H215-56K27

H215-56K39

Für die Wandmontage empfehlen wir 2 Montage Clips! /  
For wall mounting we recommend two mounting clips!



K27



K39

L	B/W	H	LA/CC	VE/PU
56	25	23	28	10

⊕↔⊖ LOCHABSTAND | CENTER TO CENTER

↔ LÄNGE | LENGTH

📦 VERPACKUNGSEINHEIT | PACKING UNIT

↔ BREITE | WIDTH

⊘ DURCHMESSER | DIAMETER

📏 HÖHE | HEIGHT

H240 Klemme selbstklebend / clamp selfadhesive



Kunststoff / plastic

Bestellnummer | Order no.  
 H240-50A3K  
 H240-50A4K  
 H240-50A105K

Montage mit Selbstklebeband oder Schrauben möglich!  
 Mounting with self-adhesive tape or screws possible!



A3

A4

A105



H213 Kabeldurchführung / cable organizer



Kunststoff / plastic

Bestellnummer | Order no.  
 H213-70A138A138  
 H213-70MV7A138

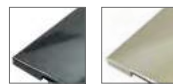

A138A138

MV7A138

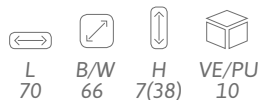

0320 Schütte / pourer



Kunststoff / plastic

Bestellnummer | Order no.  
 0320/K2  
 0320/K10



K2

K10



Abbildung: H240/A105K



2158 für Glastüren / for glass doors

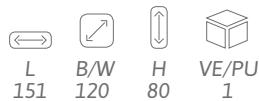

Druckguss - Kunststoff / die cast - plastic

Bestellnummer | Order no.  
2158-34ZN1SD1V1K

5 - 12 mm Tür / door



ZN1SD1

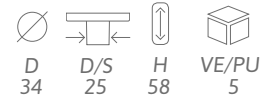

2139 für Glas- und Spiegeltüren / for glass- and mirror doors



Druckguss - Kunststoff / die cast - plastic

Bestellnummer | Order no.  
2139-20ZN1A4V2B\*  
2139-20ZN21A4V2B\*

4 - 6 mm Tür / door



ZN1

ZN21

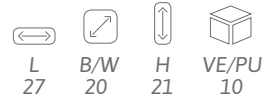

H216 für Glastüren / for glass doors



Kunststoff mit M4-Metallmuffe /  
plastic with M4 metal thread

Bestellnummer | Order no.  
H216-43A49A3V1B

5 - 12 mm Tür / door



A49A3

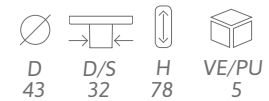

2233 Krawattenhalter / tie rail



Stahl - Druckguss / steel - die cast

Bestellnummer | Order no.  
2233-422ZN1V1K



ZN1

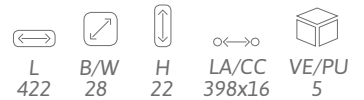

H207 Krawattenhalter selbstklebend / tie rail self-adhesive



Kunststoff - Stahl / plastic - steel

Bestellnummer | Order no.  
H207-394A3A4V1BK



A3A4





0498

Kleiderbügel / coat hanger



Kunststoff / plastic

Passend zu 0487, 0488 Seite 340  
matching 0487, 0488 page 340

Bestellnummer | Order no.  
0498/K10



K10



L  
450



B/W  
15



H  
183



VE/PU  
5



552



Druckguss / die cast

Bestellnummer | Order no.  
 552-37PB21  
 552-37ZN1  
 552-37ZN4  
 552-37ZN5  
 552-37ZN10



PB21

ZN1

ZN4

ZN5



ZN10

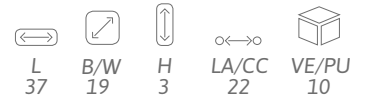

L  
37

B/W  
19

H  
3

LA/CC  
22

VE/PU  
10

482



Druckguss / die cast

Bestellnummer | Order no.  
 482-30ZN1  
 482-30ZN4  
 482-30ZN5  
 482-30ZN10



ZN1

ZN4

ZN5

ZN10

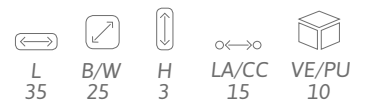

L  
35

B/W  
25

H  
3

LA/CC  
15

VE/PU  
10

401



Messing / solid brass

Bestellnummer | Order no.  
 401-48MS1  
 401-48MS3



MS1

MS3

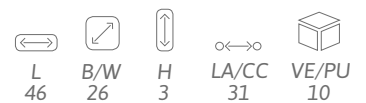

L  
46

B/W  
26

H  
3

LA/CC  
31

VE/PU  
10

365



Druckguss / die cast

Bestellnummer | Order no.  
 365-70ZN8  
 365-70ZN10



ZN8

ZN10



L  
70

B/W  
25

H  
3

VE/PU  
10

364



Druckguss / die cast

Bestellnummer | Order no.  
 364-78ZN10



ZN10



L  
78

B/W  
38

H  
3

VE/PU  
10

361



ZN8

ZN10



L  
83



B/W  
6



H  
34



VE/PU  
10

Bestellnummer | Order no.  
361-42ZN8  
361-42ZN10

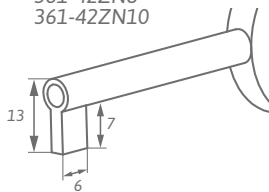

Druckguss / die cast



Abbildung: 364-78ZN10, 361-42ZN10

1449 Türstopper / door stopper



Messing - Kunststoff / solid brass - plastic

Bestellnummer | Order no.  
1449-33MS8K1



MS8K1



1448 Türstopper / door stopper



Druckguss - Kunststoff / die cast - plastic

Bestellnummer | Order no.  
1448-44ZN2K29



ZN2K29



1447 Türstopper / door stopper



Druckguss - Kunststoff / die cast - plastic

Bestellnummer | Order no.  
1447-127ZN5K29



ZN5K29

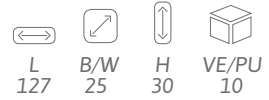

1446 Türstopper / door stopper



Druckguss - Kunststoff / die cast - plastic

Bestellnummer | Order no.  
1446-39ZN1K1  
1446-39ZN2K1



ZN1K1



ZN2K1

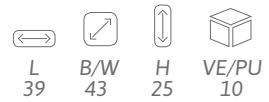

1409 Türstopper / door stopper



Edelstahl - Kunststoff / stainless steel - plastic

Bestellnummer | Order no.  
1409-35N1K1



N1K1

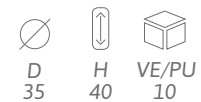

0803

Türstopper / door stopper



Kunststoff / plastic

Bestellnummer | Order no.  
0803-28MT1K1  
0803-28MV7K1



MT1K1



MV7K1



D  
30



H  
61



VE/PU  
10



Z22 Zierprofil selbstklebend / ornamental profile self-adhesive



Kunststoff / plastic

Bestellnummer | Order no.  
Z22-26MT1K



MT1

L 26	B/W 26	H 3	VE/PU 10

Z22 Zierprofil selbstklebend / ornamental profile self-adhesive



Kunststoff / plastic

Bestellnummer | Order no.  
Z22/K1MF2  
Z22/K1MF15  
Z22/K2MF1



K1MF2

K1MF15

K2MF1

L 2000	B/W 8	H 2	VE/PU 1

086 Verstellerschraube mit Schlüsselweite 12mm / adjustment screw with key-wide of 12mm



Stahl mit M10 Gewinde, Kunststoff /  
steel with M10 thread, plastic

Bestellnummer | Order no.  
086-30K1  
086-60K1



K1

D 31 31	H 33 63	VE/PU 10 10

KS



Stahl mit M4 Gewinde /  
steel with M4 thread

Bestellnummer | Order no.  
KS-16  
KS-20  
KS-23  
KS-25  
KS-28  
KS-31  
KS-35  
KS-38  
KS-40  
KS-45

D M4 M4 M4 M4 M4 M4 M4 M4 M4 M4	H 16 20 23 25 28 31 35 38 40 45	VE/PU 50 50 50 50 50 50 50 50 50 50

KS-45BREAK



Stahl mit M4 Gewinde /  
steel with M4 thread

Bestellnummer | Order no.  
KS-45BREAK-V10E\*

D M4	H 45	VE/PU 30

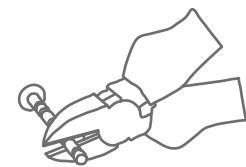

45 - 7mm

\* Bestellnr. für 10 Stück / order no. for 10 pcs.  
VE / MOQ : 30 = 300 Stück / pieces

LOCHABSTAND | CENTER TO CENTER

LÄNGE | LENGTH

VERPACKUNGSEINHEIT | PACKING UNIT

BREITE | WIDTH

DURCHMESSER | DIAMETER

HÖHE | HEIGHT

SS

Schraube für Kunststoffartikel ohne M4 Gewinde / screw for plastic items without M4 thread



Stahl / steel

Bestellnummer | Order no.

- SS-12
- SS-14
- SS-16
- SS-26
- SS-28
- SS-30
- SS-32
- SS-35
- SS-40

L	VE/PU
12	50
14	50
16	50
26	50
28	50
30	50
32	50
35	50
40	50

ST4



Stahl / steel

Bestellnummer | Order no.  
ST4\*40-S6V5E\*

L	VE/PU
40	10

\* Bestellnr. für 5 Stück / order no. for 5 pcs.  
VE / MOQ : 10 = 50 Stück / pieces



## MULTIPACKS

Ein ausgewähltes Sortiment an beliebten Möbelgriffen, Knöpfen und Haken in gängigen Größen und Formen stellen wir abgepackt zu drei, vier, fünf oder sechs Stück zur Verfügung.

Mit den praktischen Blister- und Skin-Verpackungen können unsere Produkte perfekt in Szene gesetzt werden und unseren Fachhändlern werden die Präsentation und die Lagerung erheblich erleichtert. Selbstverständlich sind diese Griffe auf Wunsch auch einzeln erhältlich.

Als umweltbewusstes Unternehmen legen wir auch in diesem Bereich hohen Wert auf eine energieeffiziente Produktion und recycelbare Verpackungen und leisten somit einen wertvollen Beitrag zum aktiven Umweltschutz.

## MULTIPACKS

A selected range of popular furniture handles, knobs and hooks in common shapes and sizes are available in packs of three, four, five or six.

The practical blister and skin packaging is perfect for displaying our products, ensuring easy storage and presentation for our retailers. These items are of course also available individually.

As an environmentally aware company, we ensure that our recyclable packaging is produced in an energy-efficient manner – therefore making a tangible contribution to actively protecting the environment.







Mitnahmeprodukt /  
Take-away product

Zusatzprodukt /  
Additional product

Preisvorteil /  
Price advantage

Eye - catcher

Wir entwerfen Ihren Exklusivartikel! /  
We design your exclusive item!

Wir machen Ihre Eigenmarke! /  
We make your own brand!

Jeder Artikel auch als Eigenmarke verfügbar - Fragen Sie uns nach den Bedingungen!  
 Each item is also available as an own brand - ask us about the conditions!

2321 selbstklebend / self-adhesive



Edelstahl / stainless steel

Bestellnummer | Order no.  
2321/N1KV3B\*

Belastungsgewicht: max. 0,3 kg /  
loading weight: max. 0,3 kg

\* Bestellnr. für 3 Stück / order no. for 3 pcs.  
VE / MOQ : 5 = 15 Stück / pieces



N1



2320 selbstklebend / self-adhesive



Edelstahl / stainless steel

Bestellnummer | Order no.  
2320/N1KV3B\*

Belastungsgewicht: max. 0,3 kg /  
loading weight: max. 0,3 kg

\* Bestellnr. für 3 Stück / order no. for 3 pcs.  
VE / MOQ : 5 = 15 Stück / pieces



N1



2319 selbstklebend / self-adhesive



Stahl / steel

Bestellnummer | Order no.  
2319/ZN1KV3B\*  
2319/ZN4KV3B\*

Belastungsgewicht: max. 0,3 kg /  
loading weight: max. 0,3 kg

\* Bestellnr. für 3 Stück / order no. for 3 pcs.  
VE / MOQ : 5 = 15 Stück / pieces



ZN1



ZN4



2211



Druckguss / die cast

Bestellnummer | Order no.  
2211-202ZN21V55\*

\* Bestellnr. für 5 Stück / order no. for 5 pcs.  
VE / MOQ : 5 = 25 Stück / pieces



ZN21

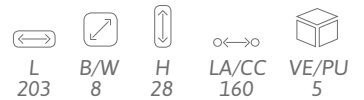

2210



Druckguss / die cast

Bestellnummer | Order no.  
2210-150ZN21V55\*

\* Bestellnr. für 5 Stück / order no. for 5 pcs.  
VE / MOQ : 5 = 25 Stück / pieces



ZN21

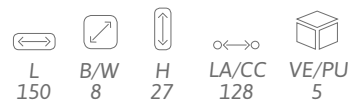

⊕↔⊖ LOCHABSTAND | CENTER TO CENTER

📦 VERPACKUNGSEINHEIT | PACKING UNIT

⊘ DURCHMESSER | DIAMETER

↔ LÄNGE | LENGTH

📏 BREITE | WIDTH

📏 HÖHE | HEIGHT

Jeder Artikel auch als Eigenmarke verfügbar - Fragen Sie uns nach den Bedingungen!  
 Each item is also available as an own brand - ask us about the conditions!

2200



Druckguss / die cast

Bestellnummer | Order no.  
 2200-184ZN1V5S\*  
 2200-184ZN21V5S\*

\* Bestellnr. für 5 Stück / order no. for 5 pcs.  
 VE / MOQ : 5 = 25 Stück / pieces



ZN1

ZN21



L  
184

B/W  
22

H  
24

LA/CC  
128

VE/PU  
5

2197



Druckguss / die cast

Bestellnummer | Order no.  
 2197-214ZN1V4S\*  
 2197-214ZN21V4S\*

\* Bestellnr. für 4 Stück / order no. for 4 pcs.  
 VE / MOQ : 5 = 20 Stück / pieces



ZN1

ZN21

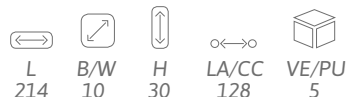

L  
214

B/W  
10

H  
30

LA/CC  
128

VE/PU  
5

2180



Stahl / steel

Bestellnummer | Order no.  
 2180-100ZN1V3B\*

17 mm Tür / door

Passend zu 2178 Seite 354, 2177 Seite 301, 2144 Seite 379  
 matching 2178 page 354, 2177 page 301, 2144 page 379

\* Bestellnr. für 3 Stück / order no. for 3 pcs.  
 VE / MOQ : 5 = 15 Stück / pieces



ZN1



L  
100

B/W  
40

H  
40

VE/PU  
5

2179



Stahl / steel

Bestellnummer | Order no.  
 2179-60ZN1V5B\*

17 mm Tür / door

Passend zu 2178 Seite 354, 2177 Seite 301, 2144 Seite 379  
 matching 2178 page 354, 2177 page 301, 2144 page 379

\* Bestellnr. für 5 Stück / order no. for 5 pcs.  
 VE / MOQ : 5 = 25 Stück / pieces



ZN1



L  
57

B/W  
30

H  
35

VE/PU  
5



Abbildung: 2210-270ZN21

Jeder Artikel auch als Eigenmarke verfügbar - Fragen Sie uns nach den Bedingungen!  
 Each item is also available as an own brand - ask us about the conditions!

2108



Bestellnummer | Order no.  
 2108-104ZN21V5S  
 2108-136ZN21V5S

Druckguss / die cast

\* Bestellnr. für 5 Stück / order no. for 5 pcs.  
 VE / MOQ : 5 = 25 Stück / pieces



ZN21

L	B/W	H	LA/CC	VE/PU
104	8	28	96	5
136	8	28	128	5

1809



Bestellnummer | Order no.  
 1809-110ZN10V5S\*

Druckguss / die cast

\* Bestellnr. für 5 Stück / order no. for 5 pcs.  
 VE / MOQ : 5 = 25 Stück / pieces



ZN10

L	B/W	H	LA/CC	VE/PU
110	14	23	96	5

1765



Bestellnummer | Order no.  
 1765-135ZN21V5S\*

Druckguss / die cast

\* Bestellnr. für 5 Stück / order no. for 5 pcs.  
 VE / MOQ : 5 = 25 Stück / pieces



ZN21

L	B/W	H	LA/CC	VE/PU
135	10	27	96	5

1756



Bestellnummer | Order no.  
 1756-46ZN10V6S\*

Druckguss / die cast

\* Bestellnr. für 6 Stück / order no. for 6 pcs.  
 VE / MOQ : 5 = 30 Stück / pieces



ZN10

L	B/W	H	VE/PU
42	46	18	5

1581



Bestellnummer | Order no.  
 1581-16ZN21V6S\*

Druckguss / die cast

\* Bestellnr. für 6 Stück / order no. for 6 pcs.  
 VE / MOQ : 5 = 30 Stück / pieces



ZN21

D	D/S	H	VE/PU
15	7	24	5

LOCHABSTAND | CENTER TO CENTER

LÄNGE | LENGTH

VERPACKUNGSEINHEIT | PACKING UNIT

BREITE | WIDTH

DURCHMESSER | DIAMETER

HÖHE | HEIGHT

Jeder Artikel auch als Eigenmarke verfügbar - Fragen Sie uns nach den Bedingungen!  
 Each item is also available as an own brand - ask us about the conditions!

1546



Bestellnummer | Order no.  
 1546-30ZN10V6S\*



ZN10

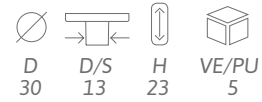

Druckguss / die cast

Passend zu 1546 Seite 124  
 matching 1546 page 124

\* Bestellnr. für 6 Stück / order no. for 6 pcs.  
 VE / MOQ : 5 = 30 Stück / pieces

1314



Bestellnummer | Order no.  
 1314-20ZN21V6S\*



ZN21



Druckguss / die cast

Passend zu 1607 Seite 310, 1606 Seite 311, 1313 Seite 140  
 matching 1313 page 310, 1606 page 311, 1313 page 140

\* Bestellnr. für 6 Stück / order no. for 6 pcs.  
 VE / MOQ : 5 = 30 Stück / pieces



Abbildung: 1546-137ZN10

Jeder Artikel auch als Eigenmarke verfügbar - Fragen Sie uns nach den Bedingungen!  
 Each item is also available as an own brand - ask us about the conditions!

908



Bestellnummer | Order no.  
 908-110ZN21V5S\*

Druckguss / die cast

\* Bestellnr. für 5 Stück / order no. for 5 pcs.  
 VE / MOQ : 5 = 25 Stück / pieces



ZN2

L	B/W	H	LA/CC	VE/PU
108	9	27	96	5

873



Bestellnummer | Order no.  
 873-34ZN4V6S\*

Druckguss / die cast

\* Bestellnr. für 6 Stück / order no. for 6 pcs.  
 VE / MOQ : 5 = 30 Stück / pieces



ZN4

D	D/S	H	VE/PU
34	14	27	5

Passend zu 1078 Seite 322, 878 Seite 166  
 matching 1078 page 322, 878 page 166

6175



Bestellnummer | Order no.  
 6175-104ZN2V5S\*  
 6175-136ZN2V5S\*

Stahl / steel

\* Bestellnr. für 5 Stück / order no. for 5 pcs.  
 VE / MOQ : 5 = 25 Stück / pieces



ZN2

L	B/W	H	LA/CC	VE/PU
104 136	8 8	27 27	96 128	5 5

H214

selbstklebend / self-adhesive



Bestellnummer | Order no.  
 H214/A4KV3B\*  
 H214/A13KV3B\*  
 H214/A49KV3B\*

Kunststoff / plastic

Belastungsgewicht: max. 0,3 kg /  
 loading weight: max. 0,3 kg

\* Bestellnr. für 3 Stück / order no. for 3 pcs.  
 VE / MOQ : 5 = 15 Stück / pieces



A4



A13



A49

L	B/W	H	VE/PU
29	18	14	5

H111

Saughaken / suction hook



Bestellnummer | Order no.  
 H111-46A45FE11V5K

Kunststoff - Druckguss / plastic - die cast

Belastungsgewicht: max. 0,5 kg /  
 loading weight: max. 0,5 kg

\* Bestellnr. für 5 Stück / order no. for 5 pcs.  
 VE / MOQ : 10 = 50 Stück / pieces



A45FE11

D	H	VE/PU
46	15	10

LOCHABSTAND | CENTER TO CENTER

LÄNGE | LENGTH

VERPACKUNGSEINHEIT | PACKING UNIT

BREITE | WIDTH

DURCHMESSER | DIAMETER

HÖHE | HEIGHT

H209 Maßband / measuring tape



Kunststoff - Stahl / plastic - steel

Bestellnummer | Order no.  
H209-68A134V1K



A134

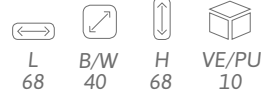

H163 Bohrschablone / drill template



Kunststoff / plastic

Bestellnummer | Order no.  
H163-288A18V1K



A18



Abbildung: H163-288A18V1K

INDIVIDUELL ENTWICKELTE VERKAUFSPRÄSENTATIONEN  
CUSTOMISED SALES PRESENTATIONS

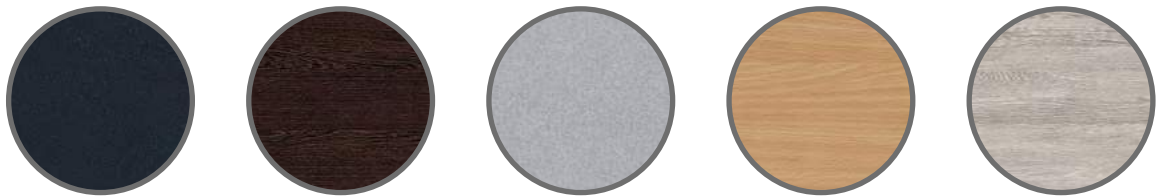

Blenden und Korpusse auch in anderen Ausführungen möglich!  
*Merchandisers and panels also available in other finishes!*



Bis zu 30 Laufmeter möglich  
Up to 30 running meters possible



## POS-DESIGN

Unsere Designs für POS-Präsentationen zeichnen sich durch hohe Flexibilität bei Aussehen, Farbe, Abmessung, Beleuchtung und der Dekoration mit speziellen Folien aus.  
Verkaufshilfen - kostenlos leihweise.

*Our designs for POS presentations are characterised by a high flexibility with regard to appearance, colour, dimensions, lighting and decoration with special foils.  
Merchandisers free of charge on agreement.*

## LAGERPROGRAMM STOCK RANGE

Das SIRO Lagerprogramm umfasst:  
The SIRO stock range comprises:

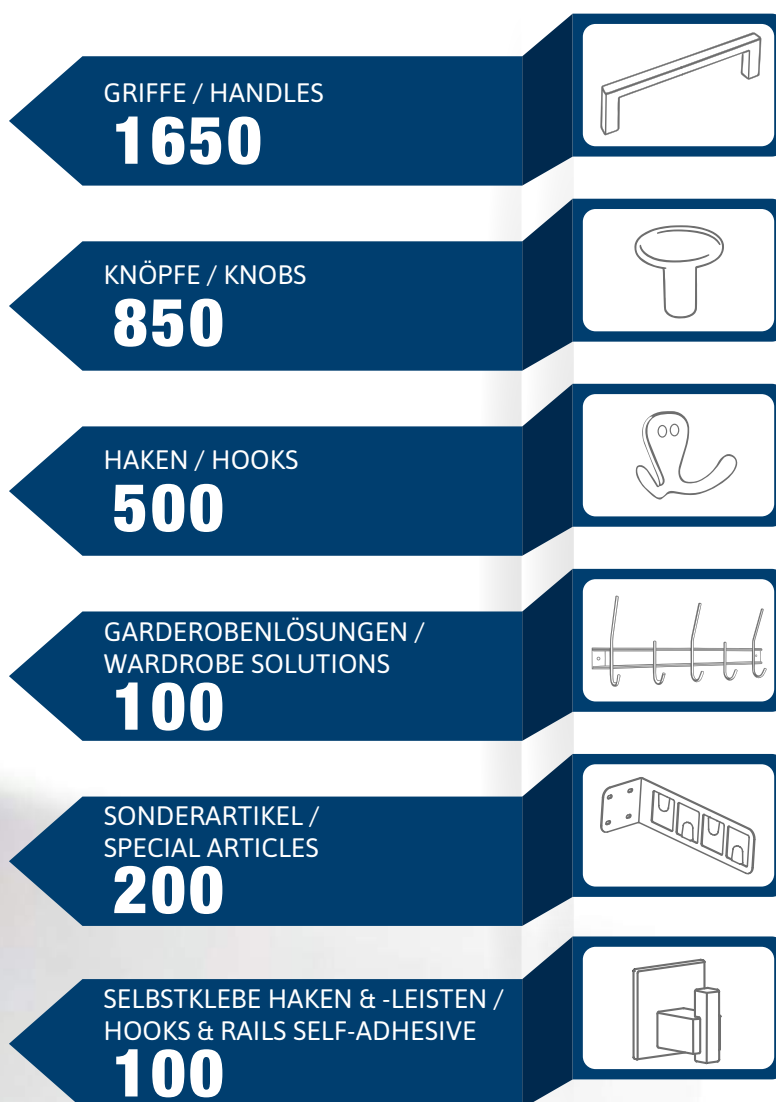

INDIVIDUELLE BESTÜCKUNG  
CUSTOMISED PRODUCT RANGE

## VERKAUFSHILFEN

Selbstverständlich unterstützen wir unsere Kunden gerne, indem wir Verkaufspräsentationen zur Verfügung stellen, die den hohen Marktanforderungen gerecht werden. Sie sind flexibel in Aussehen, Farbe und Abmessung und ermöglichen es, unser umfassendes Lagerprogramm direkt am Point of Sale in Szene zu setzen.

Speziell entwickelte Systeme erlauben eine diebstahlsichere Warenpräsentation und einen schnellen und unkomplizierten Austausch der einzelnen Artikel. Moderne Präsentationswände unterstreichen die Ästhetik und Individualität der Produkte. Dabei erleichtert eine übersichtliche Gestaltung die Beratung und Auswahl.

Unsere kompetenten Mitarbeiter beraten Sie gerne zu unserem umfangreichen Sortiment und garantieren eine rasche Abwicklung.

## DISPLAY SYSTEMS

We are more than happy to support customer by providing display stands that meet the exacting market requirements. Our display racks are flexible in terms of appearance, colour and size. And they ensure that our products can be presented right at the point of sale.

Specially developed systems enable burglar-proof product presentation and make it possible for individual items to be exchanged quickly and easily. Modern presentation walls highlight the aesthetic and individuality of the products, while a clear design helps with consultation and choice.

Our competent employees welcome any questions about our extensive product range and guarantee quick and efficient service.

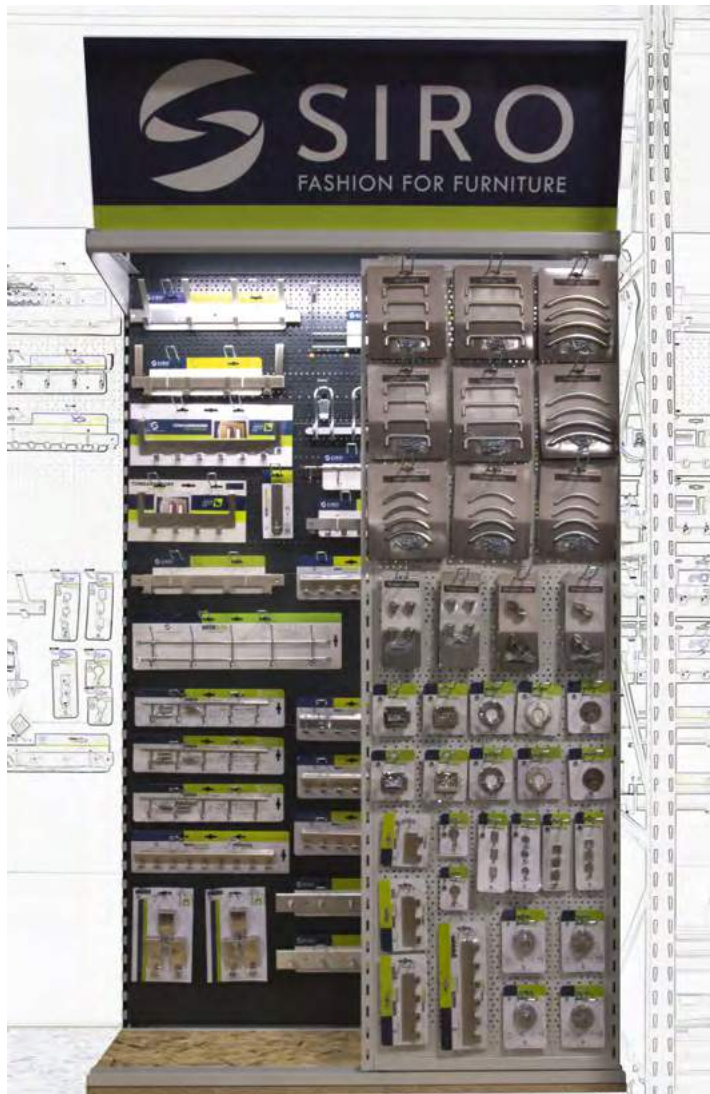

### Präsentation mit Schiebetüre

- doppelte Behangmöglichkeit durch Schiebetüre
- große Auswahl auf kleiner Fläche
- Blickfang durch Beleuchtung

### Presentation with sliding door

- sliding door allows for double hanging option
- large selection in small area
- eye-catching lighting

IHR PARTNER IM DIY-BEREICH  
Zierbeschläge optimal in Szene gesetzt

YOUR DIY PARTNER  
Decorative furniture fittings put into the spotlight



## VARIO CLICK

Das ideale System für Ihren Schaumraum (Ausstellungsraum). Es ermöglicht ein einfaches und schnelles Wechseln der ausgestellten Produkte.

The ideal system for your showroom. It allows the presented products to be exchanged easily and rapidly.

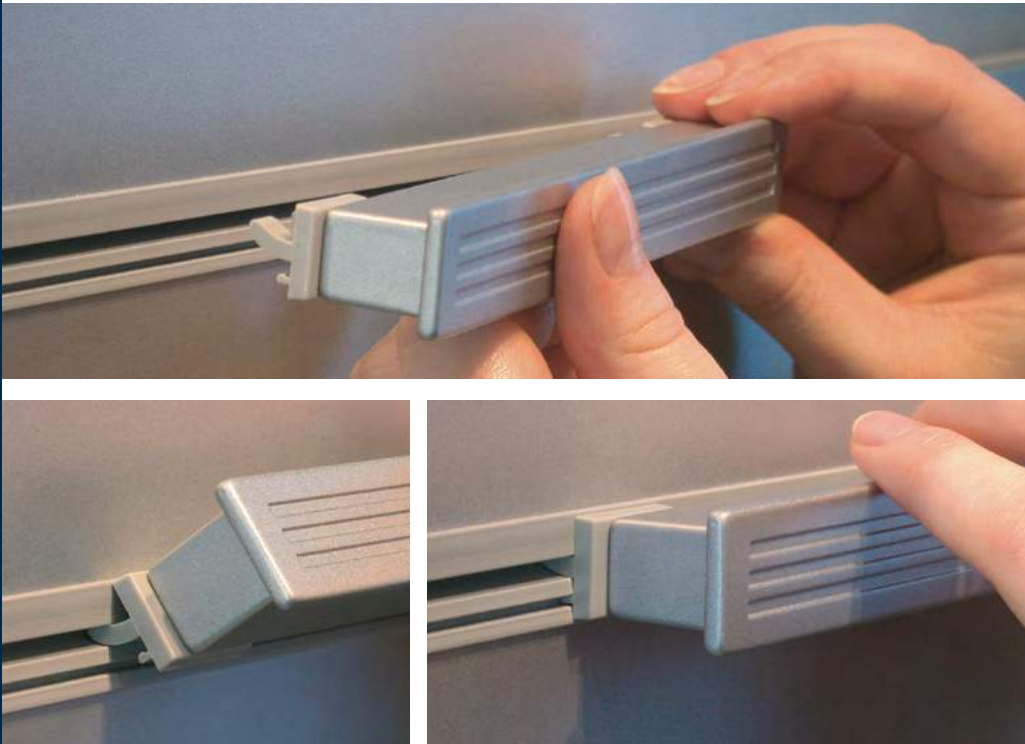

## VARIO SECURE

Das ideale System für Ihre Verkaufspräsentation im Baumarkt und im Fachhandel. Vario Click Secure sichert das gezeigte Warenmuster und bietet Schutz vor Diebstahl.

The ideal system for your sales presentation in the hardware store and in DIY shops. Vario Click Secure secures the product samples on display and offers protection against theft.



Das universell einsetzbare Warenpräsentationssystem VARIO SECURE besticht durch seine einfache aber sehr effiziente Funktionsweise.

Das System ermöglicht einen sehr einfachen und unkomplizierten Produktausgleich ohne dass die gesamte Warenblende ausgetauscht werden muss (nur mit einem speziellen Lösewerkzeug von SIRO möglich).



The universal, all-purpose merchandise display system VARIO SECURE captivates through its simple but very efficient mode of operation.

The system makes swapping products very simple and straightforward, without having to swap the total product mix (only possible with a special removal tool from SIRO).

Präsentation mit Ladenzug /  
presentation with pull-out drawers



- Bestellware
- Verblendung der Regalsteher für zusätzlichen Behang
- leichte Entnahme der Ware durch Auszug
- integrierte Behangware
- Goods to order
- Panelled uprights for additional hanging space
- Pullouts for easy product removal
- integrated hanging merchandise



Displays

- Individuelle Gestaltung
- gewölbt, beleuchtet,.....
- *individual design*
- *curved, illuminated, .....*

Behangware /  
hanging goods

großes Sortiment im  
gleichen Verpackungs-Layout

*large assortment in  
same packaging-layout*

## DREHPRÄSENTATION FÜR DEN FACHHANDEL UND SCHAURÄUME Rotary presentation for retailers and showrooms



- drehbar
- beidseitig bis vierseitig bestückbar
- Mustertafeln austauschbar durch Herausschieben
- rotatable
- double-sided to four-sided display options
- Slide-out display board exchange

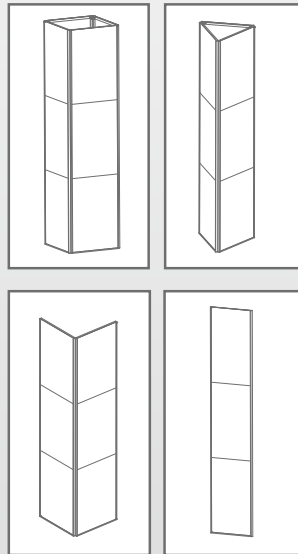

## ALURAHMENPRÄSENTATION Aluminium frame presentation

- Präsentation für Wandmontage
- pro Mustertafel 60 – 70 Beschläge
- erweiterbar mit Scharnieren (2er, 3er, 4er-Sets)
- Mustertafeln durch Einhängesystem austauschbar
- Wall-mounted presentation
- 60 – 70 fittings per sample board
- extendable with hinges (sets of 2s, 3s, 4s)
- sample boards can be slid out for exchange

erweiterbare Sets → extendable sets

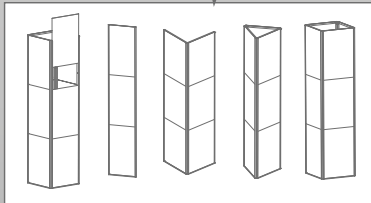

## VERKAUFSHILFEN *display racks*

Als Fachhändler stellen Sie hohe Anforderungen an sich und Ihre Produkte. Ihr Angebot zeichnet sich aus durch Qualität, Vielfalt und fachkundige Beratung. Dabei spiegelt sich Ihre Kompetenz im optischen Erscheinungsbild.

Wir von SIRO möchten unsere Produkte und damit auch Sie ins rechte Licht rücken. Daran arbeiten wir laufend. Unser Designs für POS-Präsentationen zeichnen sich durch hohe Flexibilität bei Aussehen, Farbe, Abmessung und Beleuchtung aus.

Vornehm zurückhaltende Präsentationen unterstreichen die Ästhetik und Individualität der Produkte. Dabei erleichtert eine übersichtliche Gestaltung die Beratung und Auswahl.

*You are a specialized dealer and your standards are high. You offer high class and versatile products as well as competent advice. Your competence is reflected by the optical appearance.*

*SIRO wants to put you and SIRO products into the limelight. We keep working on that. Our designs for POS presentations are characterised by a high degree of flexibility in terms of look, colour, dimensions and lighting.*

*Elegant and decent presentation panels underline the aesthetic individuality of the products.*



INDUSTRY PLUS - große Mengen ab Lager verfügbar!  
INDUSTRY PLUS - large quantities available ex stock!  
BY SIRO FASHION FOR FURNITURE



1499-16



2108-328  
2108-168  
2108-104



1750-193



2266-337  
2266-177



2011-50



2182-342  
2182-182



2198-333  
2198-173

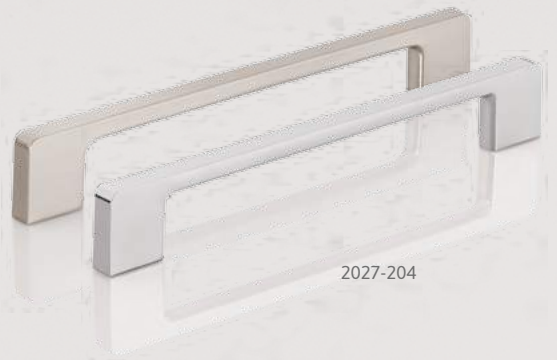

2027-204



## MUSTERKOFFER SAMPLE CASES

Unsere Musterkoffer bestechen durch ein hohes Maß an Qualität und Funktionalität.  
Die Verkaufsunterstützung für jeden optimal in Szene gesetzt!

Beeindrucken Sie bei Ihrem Kundengespräch:  
Durch eine optimale Präsentation speziell ausgesuchter Modelle.

Ab 100 Stück fertigen wir für Sie Ihren individuellen Musterkoffer!

*Our sample cases impress with a high degree of quality and functionality.  
The sales assistance are available for everyone for an optimal effect.*

*Impress at your customer meeting:  
With a perfect presentation of designs which have been selected specifically.*

*From 100 pieces we will manufacture your customised sample case!*



ab 1. Stk. erhältlich /  
available from the 1st piece

Musterkoffer/ sample case: **INDUSTRIE PLUS**

Bestellnummer | Order no.  
SAMPLEBOX-IPLUS-01

€ 29,-

- Artikel lt. Musterkoffer „Industrie Plus“ sind in größeren Mengen ab Lager verfügbar.
- Verpackung: in kleinen Mengen inkl. Schrauben, große Mengen industrieverpackt

- Items offered in the „Industrie Plus“ sample case are stocked in large quantities.
- packaging: in small quantities incl. screws, large quantities in industry packaging



ab 1. Stk. erhältlich /  
available from the 1st piece

Musterkoffer / sample case: **BESCHLÄGE TRENDS 1**

Bestellnummer | Order no.  
SAMPLEBOX-IPLUS-04

€ 29,-



# SPECIAL LIGHTING



Das kompakte und durchdachte Produktsortiment bietet unzählige Kombinationsmöglichkeiten zur Gestaltung von Licht im Möbel und Wohnraum. Dabei unterstützen steckerfertige Lichtsysteme aus den Bereichen MONO - DUO - RGB eine einfache, kostengünstige und zeiteffiziente Montage.

Kabellose, batteriebetriebene Sensoren und Zonensteuerung, extrarobuste LED Bänder mit brillianter Lichtqualität, XXL LED Bänder, Einbauspots in 7 Farben, Microwave Motion Sensor und viele weitere Produkte finden Sie im aktuellen Katalog von Siro Special Lighting oder im Internet unter [www.siro-led.at](http://www.siro-led.at).

The compact and well thought-out product range offers countless combination possibilities for designing light in furniture and living area. Ready-to-plug-in lighting systems from the MONO - DUO - RGB range support simple, cost-effective and time-efficient installation.

Wireless, battery-operated sensors and zone control, extra robust LED strips with brilliant light quality, XXL LED strips, recessed spots in 7 colours, Microwave Motion Sensor and many other products can be found in the new Siro Special Lighting catalogue or on the Internet at [www.siro-led.at](http://www.siro-led.at).



**ZONE CONTROLLER**

## ALUFLEX LED PROFIL



## WIRELESS SENSORS

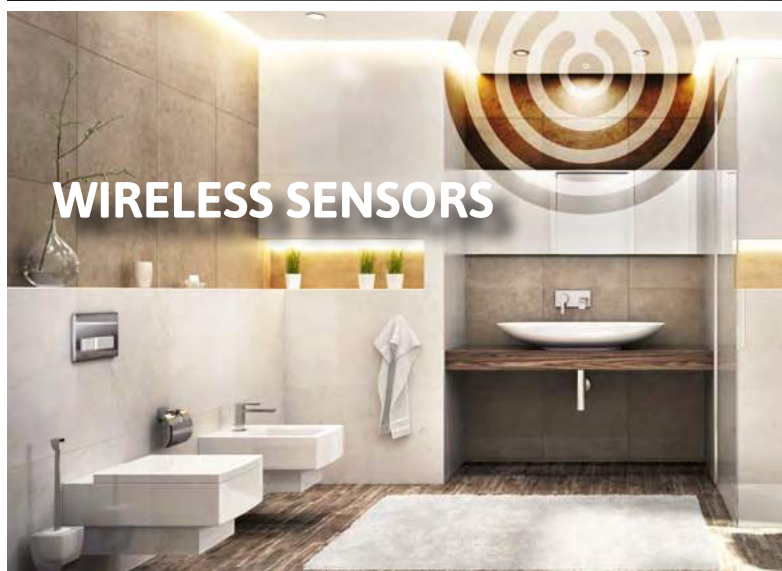



**FLEXLINE**



**STRONG & BRILLANT  
DIAMOND LED STRIPES**

**CRI 95+**



## Sehen, lernen, verstehen...

...mit dem Special Lighting Musterkoffer.

Der aktuelle SIRO Licht Musterkoffer bietet ein kompaktes, steckerfertiges Sortiment bestehend aus MONO und DUO Einbauspot, extra robusten Diamond LED Bändern, Flexline Silikon Profilen sowie kabellose, batteriebetriebene Sensoren und Zonen Steuerungen für umfangreiche Anwendungsmöglichkeiten im Möbelbau und vor allem Licht zum Fühlen, Erleben und Verstehen.

## See, learn, understand...

...with the Special Lighting Samplebox.

The current SIRO light sample case offers a compact, plug-in assortment consisting of MONO and DUO recessed spots, extra robust Diamond LED strips, Flexline silicone profiles as well as wireless, battery-operated sensors and zone controls for a wide range of possible applications in the Furniture construction and above all light for feeling, experiencing and understanding.



## Einbauspot in 7 Farben

Verfügbar mit einer Leistung von 2,5 Watt als MONO Spot wahlweise mit 3000K oder 4000K sowie als DUO Spot mit einer einstellbaren Farbtemperatur zwischen 2700 - 6000K.

## Recessed Spot in 7 Colors

Available with a power of 2,5 Watt as MONO Spot optionally with 3000K or 4000K as well as DUO Spot with an adjustable colour temperature between 2700 - 6000K.

## MONO Mini LED Spot

Verfügbar mit einer Leistung von 1 Watt als MONO Spot

## MONO Mini LED Spot

Available with a power of 1 Watt as MONO Spot



Ø 18 x 13,5 mm



# PRODUKT-FINDER

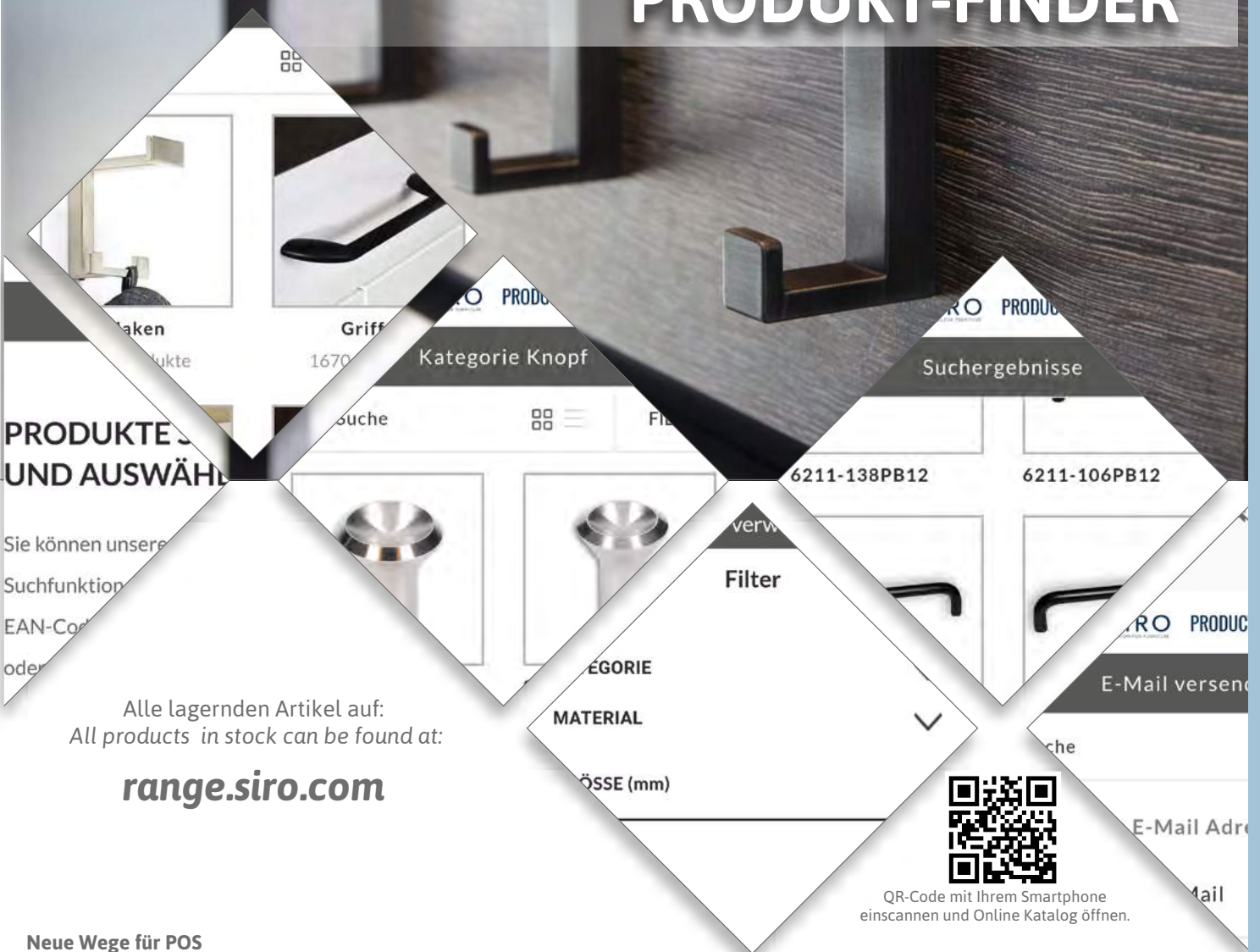

Alle lagernden Artikel auf:  
All products in stock can be found at:

**range.siro.com**

QR-Code mit Ihrem Smartphone  
einscannen und Online Katalog öffnen.

## Neue Wege für POS

Die Möglichkeiten der digitalen Welt für Möbelbeschläge. Der SIRO POS PRODUKT-FINDER als smarte Lösung für Sie und Ihre Kunden. Sie erhalten, ohne komplizierte Registrierungsvorgänge oder das Herunterladen einer App, den Zugang zu mehr als 3400 Beschlägen. Der Kunde kann direkt in Ihrem Geschäft mithilfe des PRODUKT-FINDERS das komplette SIRO Sortiment aufrufen. Ist der gewünschte Beschlag gefunden, wird dieser auf die digitale Einkaufsliste gesetzt. Die erstellte Einkaufsliste einfach per E-Mail versenden. Mit dieser Liste kann der Kunde die Wunschartikel nun direkt bei Ihnen bestellen.

## New directions for POS

The digital world offers many options for furniture fittings. The SIRO POS PRODUCT FINDER is a smart solution for you and for your customers. You get access to more than 3,400 fittings without the hassle of a complicated registration process or downloading an app. The customer can access the entire SIRO range of products from your store with the help of the PRODUCT FINDER. Once the desired fitting has been found, it is recorded in a digital shopping list. Then, just send the shopping list via e-mail. With this list, the customer can now order the desired articles directly from you.

## So funktioniert's:

- Der Kunde steht vor der Verkaufsfläche in Ihrem Haus.
- Scant mit seinem Smartphone den QR-Code zum PRODUKT-FINDER ein oder öffnet diesen mit dem angegebenen Weblink.
- Nach der kurzen 3-Schritte-Einführung kann die Suche nach dem Wunschartikel gestartet werden.
- Aus der Kategorieübersicht kann der Kunde eine Produktgruppe (Griff, Knopf, Haken etc.) auswählen.
- Zusätzlich kann auch über das Suchfeld bzw. die Filterfunktion nach Beschlägen gesucht werden.
- Ist der gewünschte Beschlag gefunden, diesen durch den Button Hinzufügen auf die Einkaufsliste setzen.
- Aus der Einkaufsliste eine PDF Artikelliste erstellen und per E-Mail versenden oder nach weiteren Artikeln suchen.
- Nicht-vorrätige Beschläge kann der Kunde mithilfe der Einkaufsliste nun direkt bei Ihnen bestellen.

## How it works :

- The customer is standing in front of the sales area in your store
- Using his smartphone, the customer scans the QR-code for PRODUCT FINDER or opens it with the link provided.
- After a short three-step introduction, he can start searching for the desired article
- The customer can select a product group (handles, knobs, hooks, etc.).
- One can also search for fitting using the search field and/or the filter function.
- Once the desired fitting has been located, the customer uses the "add" button to put it on the shopping list.
- Generate a PDF list of articles from the shopping list and send it via e-mail or continue looking for more articles.
- Fitting that aren't in-stock can be ordered directly from you using the shopping list.

### WOODEN FRAMES AND LEGS



### WOODEN HANDLES AND KNOBS



SIRO Bielsko Sp. z o.o.

ul. Strażacka 80  
 43-382 Bielsko-Biała  
 POLAND

Tel. +48 33 818 34 82  
 Fax.+48 33 818 35 74

email: [siro-bielsko@siro.com.pl](mailto:siro-bielsko@siro.com.pl)  
[www.siro.com.pl](http://www.siro.com.pl)



Fragen Sie nach unseren ständig neuen Zusatzprospekten!

Ask for the new additional brochures that we keep issuing!



1. **Geltungsbereich**  
Für sämtliche Rechtsgeschäfte zwischen dem Verkäufer und dem Käufer gelten ausschließlich diese allgemeinen Geschäftsbedingungen. Maßgeblich ist jeweils die zum Zeitpunkt des Vertragsabschlusses gültige Fassung. Sollten einzelne Bestimmungen dieser AGB nicht wirksam sein, berührt dies nicht die Wirksamkeit der verbleibenden Bestimmungen. Allgemeine Geschäftsbedingungen der Käufer oder Dritter sind für den Verkäufer selbst dann nicht verbindlich, wenn vom Käufer darauf Bezug genommen wird und der Verkäufer im Einzelfall nicht ausdrücklich widersprochen hat, es sei denn, diese werden vom Verkäufer ausdrücklich schriftlich anerkannt. Diese Bedingungen gelten bei ständigen Geschäftsbeziehungen auch für künftige Geschäfte, bei denen nicht ausdrücklich auf sie Bezug genommen wird.
2. **Angebot und Auftragsannahme**  
Die Angebote des Verkäufers, sowie Preis- und Lieferzeitangaben sind unverbindlich. Aufträge sind erst dann bindend, wenn sie vom Verkäufer schriftlich bestätigt werden. Der Verkäufer bestätigt eine Vertragsannahme stets schriftlich oder fernschriftlich, sofern nicht eine unmittelbare Lieferung bzw. Rechnungslegung erfolgt.
3. **Preise**  
Die Preise gelten im Zweifel ab Werk ausschließlich Fracht, Zoll, Einfuhrnebenabgaben und Verpackung zuzüglich Mehrwertsteuer in gesetzlicher Höhe. Alle Preise verstehen sich in Euro, sofern nicht auf der Auftragsbestätigung ausdrücklich eine andere Währung angeführt ist. Der Verkäufer behält sich vor, bei allen Änderungen der allgemeinen wirtschaftlichen Bedingungen für Roh- und Hilfsstoffe, Steuern, Transportkosten sowie Valuta-Änderungen, die vereinbarten Preise um den anteiligen Mehraufwand zu erhöhen. Der Verkäufer ist bei neuen Aufträgen (=Anschlussaufträgen) nicht an vorhergehende Preise gebunden.
4. **Gewerbliche Schutz- und Urheberrechte / Datenschutz**  
Die vom Verkäufer zur Verfügung gestellten Druckunterlagen wie Entwürfe, Zeichnungen, Verkaufshilfen und Prototypen bleiben Eigentum des Verkäufers. Die zur Verfügung gestellten Dokumente dürfen vom Käufer während und nach Beendigung des Vertragsverhältnisses ausschließlich für vom Vertrag umfasste Zwecke verwendet werden. Der Käufer ist insofern nicht berechtigt, die Dokumente ohne ausdrückliche Zustimmung des Verkäufers zu vervielfältigen oder zu verbreiten.  
Der Käufer verpflichtet sich, die im Rahmen der Geschäftsverbindung anfallenden Daten nicht an unbefugte Dritte weiterzugeben sowie diese Daten vor Zugriff und Missbrauch durch nichtberechtigte Personen sicher zu schützen und zu verwahren.  
Der Käufer verpflichtet sich weiters zur Geheimhaltung des ihm aus der Geschäftsbeziehung zugegangenen Wissens Dritten gegenüber.
5. **Versandbedingungen**  
Erfüllungsort für Lieferungen ist Ternberg.  
Der Verkäufer ist bemüht, hinsichtlich Versandart und Versandweg Wünsche und Interessen des Käufers zu berücksichtigen. Dadurch bedingte Mehrkosten - auch bei auch bei vereinbarter frachtfreier Lieferung - gehen zu Lasten des Käufers.
6. **Gefahrenübergang**  
Mit Übergabe an den Spediteur oder Frachtführer, spätestens jedoch mit Verlassen des Werkes oder Lagers, geht die Gefahr, in jedem Fall auf den Käufer über. Der Verkäufer übernimmt für die rechtzeitige Ankunft der Sendung keine Haftung.
7. **Verpackung**  
Die Verpackung erfolgt in handelsüblicher Weise zur Vermeidung von Schäden durch übliche Witterungseinflüsse unter normalen Transportbedingungen. Besondere Wünsche betreffend der Verpackung sind rechtzeitig bekannt zu geben. Rechtzeitig ist eine Bekanntgabe dann, wenn ohne Verzugsfolgen und ohne Schwierigkeiten die gewünschte Verpackung durchgeführt werden kann. Erfolgt die Bekanntgabe der besonderen Verpackungsart nicht rechtzeitig oder ist für die besondere Verpackungsart ein erheblicher Aufwand erforderlich, ist der Verkäufer berechtigt, die besondere Verpackungsart durch schriftliche Bekanntgabe abzulehnen. Die Sonderverpackung wird dem Käufer gesondert in Rechnung gestellt und nicht zurückgenommen. Für angebrochene Verpackungseinheiten wird ein Aufschlag für Bearbeitung und Manipulation verrechnet. Dieser beträgt mindestens 20 % des Wertes der angebrochenen Verpackungseinheit.
8. **Transport**  
Beschwerden zum Transport sind vom Käufer bei Erhalt der Lieferung oder Frachtdokumente unverzüglich an den letzten Frachtführer zu richten und zu dokumentieren. Von einer solchen Beschwerde ist der Verkäufer gleichzeitig zu verständigen.
9. **Gewährleistung**  
Beanstandungen wegen unvollständiger, mangelhafter oder falscher Lieferung müssen unverzüglich nach Eintreffen der Ware schriftlich an den Verkäufer erfolgen und innerhalb von acht Tagen beim Verkäufer eintreffen, andernfalls gelten die Lieferungen als genehmigt. Der Käufer ist verpflichtet, die Ware unverzüglich zu untersuchen und erkennbare Mängel unverzüglich schriftlich zu rügen. Versteckte Mängel müssen unverzüglich nach ihrer Entdeckung schriftlich gerügt werden.  
Ab Entstehen einer Rügepflicht darf eine Weiterverarbeitung, ein Einbau oder eine anderweitige Verwendung nicht mehr erfolgen; ansonsten entfällt jede Gewährleistungsfrist. Die Beweislast für das Vorliegen des Mangels im Zeitpunkt der Übergabe trifft den Käufer.
10. **Schadenersatz**  
Eine allfällige Haftung des Verkäufers ist dem Grunde nach auf solche Schäden beschränkt, die vom Verkäufer nachweislich vorsätzlich oder zumindest grob fahrlässig verursacht werden.  
Der Ersatz von Folgeschäden, bloßen Vermögensschäden, entgangenem Gewinn und von Schäden Dritter aus Ansprüchen gegen den Verkäufer, ist in jedem Fall ausgeschlossen.  
Ein allfälliger Ersatz von Schäden ist zudem der Höhe nach mit dem Auftragswert beschränkt.  
Ansprüche auf Ersatz von Schäden müssen in jedem Fall bei sonstigem Verlust längstens innerhalb von einem Jahr ab Leistungserbringung gerichtlich geltend gemacht werden.
11. **Zahlung**  
Sofern lt. Angebot oder Sondervereinbarung keine anderweitige Zahlungskondition vereinbart wurde, ist die Zahlung innerhalb von 30 Tagen ab Erhalt der Rechnung, netto ohne jeden Abzug fällig.  
Bei Zahlungsverzug werden die gesetzlichen Verzugszinsen berechnet. Die Geltendmachung eines weiteren Verzugschadens bleibt vorbehalten.  
Bei Überschreitung der Zahlungsfrist ist der Verkäufer berechtigt, gewährte Vergütungen (Rabatte, Vergünstigungen u.a.) zu widerrufen und der Rechnung zuzurechnen.
12. **Sonstiges**  
Abweichungen in den Prospekten zu den Originalen sind aus drucktechnischen Gründen möglich. Druck- und Satzfehler sind ausdrücklich vorbehalten.
13. **Eigentumsvorbehalt**  
Die Lieferungen bleiben bis zur restlosen Bezahlung uneingeschränktes Eigentum des Verkäufers.
14. **Gerichtsstand**  
Es gilt österreichisches Recht. Die Anwendung des UN-Kaufrechts wird ausdrücklich ausgeschlossen. Für Streitigkeiten ist das für Steyr, Oberösterreich sachlich zuständige Gericht örtlich zuständig.



SIRO Beschläge- und Metallwarenfabrik GmbH  
 Spielfeldstraße 12  
 A-4452 Ternberg - Austria  
 Tel: +43 (0) 7256-6020-0  
 Fax: +43 (0) 7256-8932  
 Bank / Bank / Banque:  
 Raiffeisenkasse Ennstal:  
 IBAN: AT92 3408 0000 0191 0470  
 BIC: RZOOAT2L080  
 DVR: 0031372  
 UID-Nr. ATU 24105509



1. **Scope**  
Any and all legal transactions between the seller and the purchaser are exclusively subject to these General Terms and Conditions (GTC). For each sales agreement, the GTC as amended at the date of the conclusion of the agreement shall be applicable. If individual provisions of these GTC are or become invalid, the validity of the remaining provisions shall not be affected thereby. General Terms and Conditions (GTC) of the purchasers or third parties are not binding for the seller even if the purchaser refers to them and the seller has not expressly rejected them in the specific case, unless the seller expressly accepts such GTC in writing. In ongoing business relationships, these General Terms and Conditions apply to all future transactions even without specific reference to them in each individual case.
2. **Quotations and Order Acceptance**  
The quotations of the seller and any specifications of prices and delivery periods are non-binding. Orders become binding only when they are confirmed by the seller in writing. All orders and/or sales agreements are confirmed by the seller in writing or by telex, with the exception of immediate deliveries and invoicing.
3. **Prices**  
Unless otherwise specified, prices are ex works, excluding freight, customs duty, import duties and packaging, plus statutory value-added tax. All prices are stipulated in euros, unless a different currency is expressly specified in the order confirmation. In case of changes in the general economic situation with respect to raw materials and supplies, taxes, transport costs and foreign currency exchange rates, the seller reserves the right to increase the agreed prices in accordance with the additional costs on a pro rata basis. The seller is not bound to previously valid prices for new (=follow-up) orders.
4. **Industrial Property Rights and Copyright / Privacy Policy**  
The seller retains ownership of any printed material provided, such as drafts, (technical) drawings, sales aids and prototypes, at all times. The documents provided may only be used by the purchaser for such purposes as are covered by the respective agreement, both during and after the end of the contractual relationship. In this regard, the purchaser may not copy or disclose such documents without the express consent of the seller. The purchaser undertakes not to disclose any data or information provided within the framework of the business relationship to unauthorised third parties, to protect such data and information from access and misuse by unauthorised persons and to keep it safe. The purchaser furthermore undertakes to keep any knowledge that the purchaser obtains from the business relationship secret vis-à-vis third parties.
5. **Shipping Terms and Conditions**  
The place of performance for any shipments is Ternberg, Austria. The seller strives to take the wishes and requests of the purchaser regarding the shipping mode and method into consideration. Any resulting additional cost shall be borne by the purchaser - even if the agreed delivery term is „carriage paid“.
6. **Risk Transfer**  
Upon handover of a shipment to the shipping agent or carrier, or upon leaving the works or warehouse at the latest, the risk is on principle transferred to the purchaser. The seller does not accept any liability for the timely arrival of the shipment.
7. **Packaging**  
Shipments are packaged in accordance with the prevailing industry standards to prevent damage by everyday weather under normal transport conditions. Special packaging requests or requirements have to be submitted in a timely manner that does not cause any delay or complication. If such special packaging request reaches us too late or involves significant extra handling or labour, the seller reserves the right to decline the request in writing. Any special packaging will be invoiced separately and is non-returnable. For incomplete packaging units, a surcharge in the amount of at least 20% of the value of the incomplete packaging unit is charged for processing and handling.
8. **Transport**  
The purchaser shall address any complaints about a shipment to the last shipping agent or carrier immediately upon receipt of the shipment or the bill of delivery and document them. At the same time, the seller shall be notified of such complaint beforehand.
9. **Warranty**  
Any complaints regarding incomplete, defective or incorrect shipments shall be addressed to the seller in writing immediately upon receipt of the shipment, and have to be received by the seller within eight days; otherwise, the shipments are deemed to have been accepted. The purchaser shall examine the shipment immediately and report any identifiable defects in writing without delay. Any hidden defect has to be reported immediately upon discovery in writing. As soon as the obligation to report defects applies, the defective goods may not be processed, installed or otherwise used; otherwise, any warranty obligation of the seller expires. The burden of proof for the existence of a defect at the moment of the handover rests with the purchaser.
10. **Payment of damages**  
Any liability of the seller on the merits of the case is limited to such loss or damage that was demonstrably caused wilfully or at least due to gross negligence on the part of the seller. Any payment of damages for consequential losses, purely pecuniary losses, loss of profits or losses of third parties arising from claims against the seller is excluded without exception. Furthermore, the amount of any payment of damages is limited to the value of the respective order. In any case, claims for damages have to be filed in court no more than one year after the provision of the service; otherwise, such claims expire.
11. **Payment**  
Any liability of the seller on the merits of the case is limited to such loss or damage that was demonstrably caused wilfully or at least due to gross negligence on the part of the seller. Any payment of damages for consequential losses, purely pecuniary losses, loss of profits or losses of third parties arising from claims against the seller is excluded without exception. Furthermore, the amount of any payment of damages is limited to the value of the respective order. In any case, claims for damages have to be filed in court no more than one year after the provision of the service; otherwise, such claims expire.
12. **Miscellaneous**  
Discrepancies between the brochures and actual products are possible for printing reasons. Printing and typographical errors are expressly reserved.
13. **Proprietary Rights**  
Any shipment remains the unrestricted property of the seller until full payment.
14. **Place of Jurisdiction**  
Austrian law applies. The application of the United Nations Convention on Contracts for the International Sale of Goods (CISG) is expressly excluded. The court having *ratione materiae* in Steyr, Upper Austria, shall be called for any dispute.

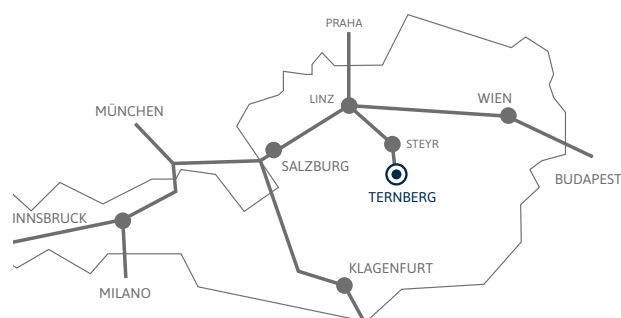
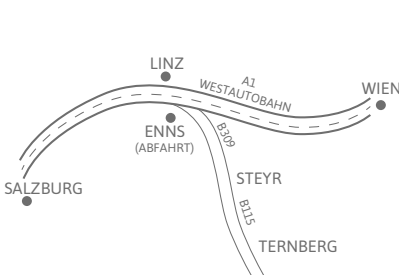

## ARTIKELSUCHE article index

Art. No.	Seite page	Art. No.	Seite page	Art. No.	Seite page	Art. No.	Seite page	Art. No.	Seite page	Art. No.	Seite page	Art. No.	Seite page
086	402	0970	372	557	327	906	196	1098	322	1304	142	1485	134
0104	223	0976	210	558	326	906	203	1115	322	1309	140	1488	134
0192	223	01006	210	563	176	908	164	1116	322	1310	140	1493	134
0287	223	01007	382	564	176	908	410	1117	150	1313	140	1497	132
0291	223	01011	210	565	176	909	164	1126	150	1314	140	1498	132
0292	341	01018	338	575	349	910	164	1131	321	1314	409	1499	132
0294	222	01019	338	577	349	911	164	1132	321	1315	146	1500	132
0297	222	01020	338	579	349	912	164	1133	320	1321	314	1502	132
0320	395	01023	210	580	326	913	163	1134	320	1322	314	1503	130
0364	222	01028	206	581	326	914	163	1135	369	1323	140	1504	130
0385	222	01031	206	582	326	915	163	1136	320	1324	139	1505	130
0387	221	01040	338	583	326	916	162	1137	320	1329	138	1506	130
0391	221	01045	206	584	348	917	162	1138	320	1332	138	1509	129
0416	341	01047	372	605	299	918	162	1139	150	1334	368	1515	129
0417	340	01055	208	606	299	919	162	1140	150	1339	138	1516	128
0428	221	01056	208	618	370	920	162	1141	298	1340	138	1517	128
0434	220	01057	208	639	173	921	161	1142	298	1349	138	1518	128
0436	220	01060	208	640	172	922	161	1161	370	1353	314	1527	128
0443H	220	01061	208	641	172	923	161	1163	370	1354	314	1528	128
0453	220	01085	392	646	172	924	160	1180	148	1355	368	1529	127
0464	372	01086	392	657	172	925	160	1183	148	1365	137	1530	193
0475H	220	01094	394	703	325	926	160	1185	148	1366	137	1531	192
0487	340	327	330	704	324	930	160	1188	148	1367	137	1532	127
0488	340	328	330	742	172	932	159	1195	148	1368	136	1533	126
0498	397	356	182	743	324	933	159	1198	147	1400	337	1534	126
0503	219	357	182	743	355	935	159	1207	147	1401	337	1535	126
0506	219	361	182	744	348	939	158	1208	147	1402	196	1536	124
0511	219	361	399	745	324	940	158	1209	146	1403	196	1537	124
0516	218	364	182	746	324	1000	158	1210	146	1404	196	1538	126
0540	218	364	398	748	324	1001	158	1211	146	1405	195	1540	126
0549	218	365	182	749	370	1003	157	1213	146	1406	195	1541	125
0551	217	365	398	753	171	1013	157	1217	319	1406H	195	1542	125
0556	216	392	181	764	171	1021	156	1218	318	1407	194	1543	125
0563	216	397	180	769	170	1022	156	1220	318	1408	194	1546	124
0571	216	398	180	795	170	1024	370	1223	144	1409	400	1546	409
0602	216	401	398	795	198	1026	156	1225	144	1410	381	1548	124
0606	216	418	330	805	170	1029	156	1227	144	1411	368	1549	124
0616	340	423	180	806	170	1034	158	1228	144	1412	381	1563	123
0617	340	430	330	809	170	1042	156	1230	318	1413	380	1567	122
0618	215	431	330	811	168	1044	155	1232	318	1420	313	1576	122
0619	215	479	180	812	168	1045	154	1235	144	1421	312	1577	122
0621	214	481	180	815	168	1046	154	1236	317	1424	136	1578	122
0653	214	482	398	816	168	1047	154	1237	317	1424	312	1579	122
0695	214	487	178	817	323	1048	154	1238	143	1425	136	1580	120
0706	214	489	178	818	168	1049	154	1241	318	1425	312	1581	120
0715	214	490	178	819	167	1051	153	1245	143	1426	136	1581	408
0753	213	494	178	820	167	1052	153	1253	142	1426	312	1582	120
0765	213	504	329	851	323	1053	152	1265	317	1427	136	1583	120
0771	212	505	329	869	166	1056	152	1267	142	1427	312	1585	192
0803	401	506	329	871	166	1057	152	1268	142	1443	380	1586	118
0819	212	507	328	872	166	1058	152	1277	316	1444	367	1587	118
0823	212	522	178	873	166	1059	152	1278	316	1446	400	1588	118
0824	212	523	177	873	410	1064	323	1279	316	1447	400	1592	116
0839	212	527	177	878	166	1071	348	1280	316	1448	400	1595	118
0841	372	531	177	885	165	1072	149	1281	316	1449	400	1596	118
0853	339	547	328	897	198	1075	149	1290	368	1463	311	1597	116
0858	339	548	328	898	198	1076	348	1292	315	1464	367	1600	116
0859	338	549	176	900	198	1082	149	1293	315	1471	194	1601	116
0902	240	550	176	901	198	1083	348	1294	314	1472	194	1602	116
0903	240	552	398	902	197	1095	150	1295	368	1474	135	1603	366
0951	211	553	328	903	197	1096	322	1296	381	1478	134	1604	311
0952	210	554	328	904	196	1097	322	1303	142	1480	134	1605	311

# ARTIKELSUCHE article index

Art. No.	Seite page	Art. No.	Seite page	Art. No.	Seite page	Art. No.	Seite page	Art. No.	Seite page	Art. No.	Seite page
1606	311	1767	103	1972	90	2089	79	2200	407	2316	334
1607	310	1768	103	1973	90	2090	79	2204	68	2318	60
1611	192	1769	102	1977	380	2091	81	2205	68	2319	354
1612	192	1770	102	1979	305	2092	80	2206	68	2319	406
1613	192	1771	102	1980	304	2093	80	2208	68	2320	354
1621	41	1772	102	1981	304	2094	80	2209	68	2320	406
1624	112	1783	366	1982	304	2095	80	2210	67	2321	354
1628	190	1784	102	1983	380	2096	80	2210	406	2321	406
1631	115	1785	306	1986	90	2100	79	2211	67	2322	354
1632	114	1786	306	1987	90	2104	79	2211	406	2323	360
1633	114	1787	308	1996	382	2105	78	2213	301	2324	300
1634	114	1788	308	2005	40	2106	336	2214	301	2325	300
1635	114	1789	308	2006	84	2107	302	2215	362	2326	300
1636	114	1791	101	2010	88	2108	78	2226	362	2328	60
1651	112	1808	101	2011	88	2108	202	2227	296	2330	353
1652	112	1809	100	2013	88	2108	408	2231	66	2331	352
1653	310	1809	408	2014	88	2110	78	2233	396	2332	352
1654	310	1810	100	2015	85	2112	76	2234	296	2333	352
1658	337	1816	100	2016	84	2113	76	2235F	296	2334	352
1659	190	1821	306	2019	304	2116	76	2235F	388	2335	352
1660	190	1824	336	2020	304	2118	76	2236F	296	2336	298
1661	112	1825	336	2021	88	2120	75	2236F	388	2337	298
1663	112	1829	380	2023	87	2127	75	2237	66	2338	60
1666	111	1835	100	2024	86	2129	75	2238	66	2340	58
1667	111	1837	100	2025	86	2136	73	2255	362	2341	58
1668	110	1870	75	2026	86	2139	396	2256	362	2343	58
1669	310	1871	306	2027	86	2142	393	2257	378	2350F	56
1670	310	1874	99	2027	203	2143	379	2258	336	2352	390
1671	110	1875	366	2028	85	2144	379	2259	336	2355	294
1672	308	1881	97	2029	85	2150	72	2261	66	2356	36
1673	366	1882	99	2032	84	2151	74	2262	66	2356	56
1674	366	1883	99	2033	84	2152	74	2266	64	2360	332
1681	110	1884	98	2035	84	2155	74	2267	64	2361	390
1682	110	1885	98	2036	203	2156	73	2275	189	2363	298
1692	110	1886	98	2037	203	2157	73	2277	189	2372	40
1696	109	1887	98	2038	203	2158	396	2279	189	2372	186
1697	109	1888	98	2039	82	2159	74	2280	189	2373	39
1699	109	1889	97	2040	202	2160	72	2282	335	2373	186
1700	108	1890	365	2042	74	2161	72	2283	335	2374	56
1701	107	1891	365	2050	303	2162	72	2284	64	2377	292
1702	107	1896	96	2051	303	2163	72	2285	62	2378	378
1704	107	1897	96	2052	302	2165	363	2286	334	2381	54
1705	106	1898	96	2053	77	2170	71	2287	301	2382	54
1706	106	1906F	96	2053	202	2177	302	2291	188	2384	54
1709	106	1908	96	2057	77	2178	354	2292	188	2387H	186
1739	190	1916	94	2063	77	2178	355	2293	188	2388	52
1745	108	1917	94	2064	76	2179	378	2294	188	2389	52
1746	108	1918	94	2073	83	2179	407	2295	296	2390	388
1747	308	1919	94	2074	83	2180	378	2299	393	2391	52
1748	108	1920	94	2075	83	2180	407	2300	393	2392	50
1750	108	1932	93	2076	82	2182	70	2301	334	2394	50
1756	106	1935	93	2077	364	2183	70	2302	334	2399	378
1756	408	1938	306	2081	302	2184	70	2303	355	2403	332
1757	106	1956	92	2081	364	2188H	190	2305	362	2411	46
1760	105	1957	92	2081DM	302	2196	363	2306	62	2412	50
1761	104	1958	92	2081DM	364	2197	70	2307	62	2413	48
1762	104	1959	92	2082	82	2197	202	2308H	188	2414	48
1763	104	1960	92	2083	364	2197	407	2311	40	2415	48
1764	104	1968	91	2084	82	2198	70	2312	360	2416	46
1765	104	1969	91	2086	82	2198	202	2313	300	2418	332
1765	408	1970	91	2087F	81	2199	69	2314	300	2419	186
1766	103	1971	90	2088	364	2200	69	2315	334	2422	386
										2423H	186
										2429	386
										2430	360
										2431	390
										2432	294
										2433	294
										2434	292
										2435	292
										2438	46
										2439	45
										2440	44
										2441	44
										2442	44
										2446	38
										2447	36
										2448	43
										2452	360
										2453	290
										2454	36
										2457	42
										2458	42
										2459	386
										2462	290
										2463	290
										2464	42
										2466	38
										2467	38
										6175	174
										6175	410
										6211	174
										6211A	174
										6300	175
										A549	218
										G17	276
										G18	276
										H007	343
										H008	342
										H022	249
										H023	249
										H024	249
										H025	249
										H026	248
										H027	248
										H028	248
										H029	248
										H030	248
										H033	342
										H039	247
										H040	247
										H041	246
										H042	246
										H043	246
										H044	246
										H045	246
										H046	244
										H047	244
										H048	244
										H049	244
										H050	244
										H060	242
										H061	242
										H064	242

## ARTIKELSUCHE article index

Art. No.	Seite page	Art. No.	Seite page	Art. No.	Seite page	Art. No.	Seite page
H065	242	H210L	226	S641	376	SP43	270
H067	242	H210R	226	S647A	279	SP44	270
H068	242	H213	395	S652A	278	SP46	270
H072	228	H214	356	S653A	278	SP51	269
H078	240	H214	410	S655	278	SP54	269
H082	238	H215	394	S656	278	SP55	268
H083	237	H216	396	S657	278	SP56	268
H084	237	H233	225	S660	376	SP57	268
H085	236	H234	224	S662	376	SP58	268
H086	236	H235	224	S668	376	SP59	268
H087	236	H240	395	S669	276	SP60	267
H099	238	H241	224	SM009	259	SP61	266
H100	238	H242	224	SM043	259	SP65	266
H101	238	H243	224	SM050	259	SP68	356
H104	238	KS	402	SM064I	263	SP69	266
H105	235	KS-45	402	SM065	258	SP76	266
H106	234	L32	276	SM083I	258	SP81	266
H107	234	L36	344	SM440	258	SS	403
H108	234	L150	344	SM447	258	ST4*	403
H109	234	LE004	262	SM873	258	TR01	272
H110	234	LE005	262	SM8004	256	TR02	272
H111	342	M549	218	SM8004F	252	Z22	402
H111	410	M618	215	SM8004I	252		
H114	356	M1687	382	SM8014I	256		
H117	232	S30	287	SM8021	256		
H118	232	S30A	287	SM8059I	256		
H119	232	S50	286	SM8059I	263		
H121	232	S50A	286	SM8064I	263		
H122	231	S60	276	SM8066I	256		
H123	231	S70	286	SM8077F	263		
H124	231	S70A	286	SM8086	255		
H125	230	S87	285	SM8094I	255		
H126	230	S87A	285	SM8095	254		
H127	230	S109	345	SM8103	254		
H135	236	S113	285	SM8104	254		
H138	236	S120	284	SM8105I	254		
H143	230	S121	345	SM8111	254		
H144	230	S123	377	SM8116I	253		
H147	228	S124	377	SM8117I	253		
H148	228	S126	377	SM8118I	252		
H149	228	S154	344	SM8119I	252		
H150	228	S155	344	SM8121I	263		
H152	227	S156	344	SM8137F	252		
H156	227	S157	284	SM8137F	262		
H157	226	S177	284	SM8161	375		
H158	226	S217	284	SM8162	375		
H159	226	S229	284	SM8163	374		
H163	411	S231	283	SM8164	374		
H170	262	S251	282	SM8177	374		
H184	374	S251A	282	SM8187I	250		
H190	374	S300	282	SM8189I	250		
H191	262	S301	282	SM8194I	250		
H194	342	S307	376	SM8195I	250		
H195	342	S351	282	SM8196F	250		
H197	232	S358	281	SM8252	343		
H198	356	S358A	281	SM8257F	252		
H199	356	S367	281	SP1	272		
H200	299	S423	280	SP5	272		
H205	372	S423A	280	SP6	272		
H206	382	S424	280	SP7	271		
H207	396	S637A	280	SP8	270		
H209	411	S638	280	SP36	270		



# AUSFÜHRUNGSBEZEICHNUNG

<b>A Kunststoff</b>	<b>GH Glaseffekt - Hintergrund lackiert</b>	<b>MS Messing - massiv</b>	<b>SF Kunststoff - Holzstruktur</b>
A3 schwarz	GH1 weiß	MS1 Messing poliert	SF224 Buche
A4 weiß	GH2 schwarz	MS2 Messing feingeschliffen	
A5 rot		MS3 Messing brüniert	<b>SN Kunststoff - Glaseffekt</b>
A7 braun	<b>GL Kunststoff - glasiert</b>	MS4 Chrom glänzend	SN1 transparent
A9 multicolor	GL35 schwarz	MS8 Edeldstahleffekt	SN9 orange
A12 braun	GL36 weiß		SN10 rot
A13 Chrom matt	GL39 marinblau	<b>MT Kunststoff - metallisiert</b>	SN11 rosa
A15 Silber antik	GL41 pink	MT1 Chrom glänzend	SN12 hellgrün
A17 transparent blau/rot		MT3 Gold glänzend	SN13 hellblau
A18 transparent blau	<b>HZ Holz</b>	MT7 Nickel matt	SN14 olivgrün
A20 lila	HZ1 Eiche		SN15 gelb
A22 rot antik	HZ2 Eiche lackiert	<b>MV Kunststoff - metallic velour</b>	SN16 blau
A24 grün antik	HZ4 Buche auf Mahagoni lackiert	MV2 Chrom	SN17 grün
A25 lachsrot	HZ5 Kiefer	MV7 Nickel	SN18 orange
A28 Messing brüniert	HZ6 Kiefer lackiert	MV10 anthrazit	SN19 pink
A29 rot	HZ11 Esche	MV11 Aluminium	SN26 himbeerrot
A38 elfenbein	HZ13 Kirsch lackiert	MV106 Aluminium	
A39 Teddy Bär	HZ14 Eiche lackiert		<b>SP weißes Keramik</b>
A40 Nilpferd	HZ16 Fichte	<b>N Edelstahl</b>	
A41 Löwe	HZ17 Buche	N1 Edelstahl	<b>T Kunststoff – Gummieffekt (Soft Touch)</b>
A42 Zebra	HZ18 Buche lackiert		T7 schwarz
A43 Marienkäfer	HZ21 Buche weiß lackiert	<b>PB Metall</b>	T16 blau
A44 Wespe	HZ33 Erle	PB1 weiß	
A45 transparent	HZ34 Ahorn lackiert	PB6 rubinrot	<b>TK Terrakotta</b>
A49 Chrom glänzend	HZ35 Ahorn	PB7 schwarzbraun	TK2 natur/weiß
A51 pink	HZ37 Erle lackiert	PB8 schwarz	
A53 orange	HZ42 Kiefer weiß lasiert	PB12 schwarz matt	<b>TX Kunststoff - Textil</b>
A54 rot	HZ46 Buche Aluminium	PB13 Gold matt	TX1 grün
A55 gelb	HZ55 Nuss lackiert	PB15 schokoladenbraun	
A56 lila	HZ61 Kirsche auf Mahagoni lackiert	PB16 schwarz antik	<b>VG Kunststoff Vollmaterial</b>
A57 gelb	HZ62 Buche auf Wenge lackiert	PB18 dunkelgrau	VG1 schwarz
A58 weiß	HZ63 Buche auf Mahagoni lackiert	PB19 silbergrau	
A59 rosa	HZ64 Buche pink lackiert	PB20 antikbraun	<b>ZN Metall - galvanisiert*</b>
A66 weiß/pink	HZ66 Buche pink lackiert	PB21 Aluminium	ZN1 Chrom glänzend
A67 gelb/weiß	HZ67 Buche blau lackiert	PB32 weiß matt	ZN2 Chrom matt
A68 weiß/gelb	HZ68 Buche gelb lackiert	PB32C weiß matt lackiert	ZN3 Nickel glänzend
A78 beige	HZ69 Eiche auf Birkenrinde lackiert	PBS22 cremeweiß	ZN4 Nickel matt
A79 rosa	HZS224 Birke/Kirsche lackiert		ZN5 Messing glänzend
A80 blau		<b>PC Keramik - Cracked-Effekt</b>	ZN8 Eisen brüniert
A81 Nickel	<b>J Kristall</b>	PC5 hellbeige	ZN8+ Eisen brüniert gebürstet
A83 rosa	J1 klar 3 x 3 mm	PC6 beige/grau	ZN9 Zinn brüniert
A84 grün	J3 klar 5 mm		ZN10 Messing brüniert getrommelt
A105 Aluminium	J13 klar 2,8 mm	<b>PD Keramikdruck</b>	ZN10+ Messing brüniert gebürstet
A109 Aluminium		PD1 Gold	ZN15 schwarz matt
A110 weiß transluzent	<b>JE Juweleffekt (Strass)</b>	PD3 blau	ZN16 Schwarzchrom glänzend
A123 rot	JE4 klar 14 mm	PD5 grau	ZN19 Kupfer brüniert
A124 blau	JE7 Blüte klar		ZN20 Gold
A134 gelb/schwarz	JE8 Blüte blau/rot	<b>PF Keramik - färbig</b>	ZN21 Edeldstahleffekt
A138 anthrazit	JE17 klar 4 mm	PF10 multicolor	ZN22 Chrom feingeschliffen
A139 grau		PF11 multicolor	ZN24 Kupfer brüniert
A141 silbergrau	<b>K Kunststoff</b>	PF12 multicolor	ZN27 Edeldstahleffekt matt
	K1 schwarz	PF13 multicolor	ZN28 Zinn
<b>AC Acrylfarben</b>	K2 braun	PF14 multicolor	ZN29 Silber antik
AC1 transparent klar	K7 feuerrot	PF15 multicolor	ZN31 Messing brüniert
AC14 transparent blau	K10 weiß	PF16 multicolor	ZN32 Zink
	K12 braun transparent	PF17 gelb	ZN33 grün
<b>AL Aluminium - eloxiert</b>	K19 brillantblau	PF18 gelb/Mandala	ZN34 blau
AL1 Natur matt	K27 silbergrau	PF19 orange	ZN35 schwarz
AL2 Natur gegläntzt	K29 steingrau	PF20 orange/Mandala	ZN36 Zinn antik
AL26 Gold matt	K31 rubinrot	PF21 hellbeige	ZN37 Silber antik
AL62 Nickel matt	K39 hellgrau	PF25 weiß/blau	ZN40 Kupfer antik
AL72 Edeldstahleffekt	K52 schwarzbraun	PF30 dunkelblau/weiß	ZN43 Messing brüniert
	K60 reinweiß	PF31 multicolor	ZN46 Silber antik
<b>BD Kunststoff - Bild Dekor</b>	K63 achatgrau	PF32 weiß/blau	ZN48 Messing brüniert
BD18 multicolor	K72 pfirsich	PF33 multicolor	ZN50 Zinn antik
	K77 Silber matt	PF34 weiß/Floral	ZN51 Zinn poliert
<b>BDJ Kunststoff - Bild Dekor (mit Glitzerstein)</b>	K81 lila		ZN53 Silber matt
BDJ1 blau/Zug	K87 weiß	<b>PU Kunststoff geschäumt</b>	ZN57 Zinn antik
BDJ2 rosa/Fee	K90 perlgrau	PU4 Delfin	ZN58 Messing brüniert
BDJ3 blau/Auto			ZN60 Messing brüniert weiß
	<b>KG Kunststoff - Glaseffekt</b>	<b>RP Kunststoff ummantelt</b>	ZN61 weiß
<b>CF Kunststoff Colourfolieneffekt</b>	KG11 orange	RP85 Aluminium	ZN63 Eisen antik
CF1 weiß			ZN66 rostbraun
CF3 karminrot	<b>KGSA Kunststoff - Glaseffekt (SAN)</b>	<b>RU Kunststoff - Gummieffekt</b>	ZN68 Schwarzchrom matt
CF7 blau	KGSA1 klar	RU1 rot	ZN74 Kupfer gebürstet matt
	KGSA3 blau	RU2 weiß/schwarz	ZN75 Eisen gebürstet
<b>CP Kunststoff - Holzeffekt</b>	KGSA5 grün	RU3 gelb	ZN77 Kupfer schwarz
CP2 Rotbuche		RU4 blau	ZN78 Eisen getrommelt
CP34 Nuss	<b>KGSU Kunststoff - Glaseffekt (Surlyn)</b>	RU5 rosa	ZN79 Messing antik gebürstet
CP100G Wurzelholz	KGSU1 klar	RU6 orange	ZN80 Chrom matt
CP123M Roterle	KGSU3 grün	RU8 rosa	ZN81 Edeldstahleffekt
	KGSU4 rot	RU12 bunt	ZN82 Messing matt
<b>DB Druckbild für Kunststoff</b>		RU13 bunt	ZN83 Vintage Gold
DB3 Buche	<b>KM Kunststoff - Glaseffekt matt</b>	RU14 grau	
	KM1 natur	RU15 grün	<b>ZNS Metall - galvanisiert*</b>
<b>DK Dekoreffekt für Kunststoff</b>	KM3 blau	RU36 dunkelblau	ZN55 Messing antik
DK5 Rose bunt	KM9 jadegrün	RU40 grün	
DK193 Wenge		RU41 blau	
	<b>KMSU Kunststoff-Glaseffekt matt (Surlyn)</b>	RU42 rot	
<b>E Kunststoff - Edeldstahleffekt</b>	KMSU5 gelb	RU43 blau	
E2 Edeldstahleffekt	KMSU7 blau	RU44 lila/pink	
		RU45 bunt	
<b>FE Eisen</b>	<b>LS Kunstleder</b>	RU46 bunt	
FE2 Chrom poliert	LS7 schwarz	RU47 bunt	
FE11 Stahlblech verzinkt	LS8 braun		
FE13 Tafellack schwarz	LS9 beige	<b>S Kunststoff</b>	
		S90 schwarz/Aluminium	
<b>G Kunststoff - galvanisiert</b>	<b>MC Kunststoff - Metall</b>		
G1 Chrom glänzend	MC23 lila	<b>SD Kunststoff - Steindekor</b>	
		SD1 weiß/transparent	
<b>GE Kunststoff - Glaseffekt</b>	<b>MF Kunststoff - Metallfolieneffekt</b>	SD3 weiß/anthrazit	
GE1 klar	MF1 Gold glänzend		
GE8 hellgrün	MF2 Silber glänzend		
GE28 lachs	MF15 Titan silber		
	MF18 Aluminium		

\*Vintagefarben: können aufgrund manueller Bearbeitung Oberflächenunterschiede aufweisen.



**LAGERPROGRAMM** STOCK RANGE  
VERSION 2.0



Hier bleiben Sie auf dem Laufenden  
Stay up to date

[www.siro.at](http://www.siro.at)

SIRO Beschläge- und Metallwarenfabrik Ges. m. b. H.  
Spielfeldstraße 12 / 4452 Ternberg / Austria  
Tel: +43 (0) 7256.6020.0 / Fax: +43 (0) 7256.8932  
E-Mail: [office@siro.at](mailto:office@siro.at)

 **SIRO**  
FASHION FOR FURNITURE